

DISCOVERY

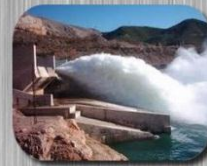

Foreign Trade Consultants & Marketing Solutions



KEŞİF DIŞ TİCARET VE PAZARLAMA ÇÖZÜMLERİ

Aydinli Yolu Cad.Bahçelievler Mah.Eryetis Sitesi B/Blok No: 33 Kat:6 Daire: 21 Pendik - İstanbul

Tel: 0090 216 483 35 65 Fax: 0090 216 483 35 26

www.discovery-trd.com email: dscovey@discovery-trd.com

DISCOVERY



Foreign Trade Consultants & Marketing Solutions

DISCOVER YOUR GLOBAL SOLUTION PARTNER

To establish a team for the following of foreign trade procedure (Official legislative procedures , import- export customs clearance procedures, logistics, payment and bank foreign exchange transactions) and sales of industrial products in the international market and to find new markets and customers is difficult and expensive for the Medium and Small Turkish Manufacturers.

Because of this necessity Discovery Foreign Trade Consultant & Marketing Solutions Co. has been established at 2002 in Istanbul.

Main Target and mission of the " Discovery Foreign Trade Co. " to serve their Turkish , European and Middle-Eastern customer for their foreign trade operations and importing and exporting any kind of industrial products the International Markets.

Discovery foreign Trade Co. offer a complete range of global business & marketing solutions to assist clients get where they want to go smoothly , cost and time effectively . Our mission it is to facilitate global business & marketing solutions.

" Discovery Foreign Trade Co. " serve Turkish Manufacturers and Trading Companies to keep in touch Middle-Eastern, East European, Turkic Republics customers with expert team and we find required products of foreign customers from Turkey or International Market by the way of our Head Office in Istanbul , and Branch offices in United States , Germany , Ukraine and Jordan.

All of our supplied products have been used by our customers in their following industrial establishments & sites;

- * Electricity Industry and Machinery,
- * H.V. , L.V. and M.V Electricity Center
- * H.V. , L.V. and M.V Electricity Substations
- * Over Head Lines , Gantries
- * Iron Steel Factories
- * Cement Factories
- * Water Pump Stations
- * Sewage Stations,
- * Solar , Wind , Hydro , Thermal , Oil , Gas and Coal Power Plants
- * High Way , Rail Way
- * High Buildings, Hotels and Plazas.



Please check List of Our Product Range and if you have any inquiry please do not hesitate to contact with us.



KEŞİF DIŞ TİCARET VE PAZARLAMA ÇÖZÜMLERİ

Aydınlı Yolu Cad. Bahçelievler Mah. Eryetİs Sitesi B/Blok No: 33 Kat:6 Daire: 21 Pendik - İstanbul

Tel: 0090 216 483 35 65 Fax: 0090 216 483 35 26

www.discovery-trd.com email: dscovey@discovery-trd.com



DISCOVERY



EVERYTHING FOR INDUSTRY & SERVICES

- ✕ Steam Boilers & Heat Exchangers
- ✕ Low Voltage, Medium Voltage and High Voltage Power Cables
- ✕ Instrument Cables
- ✕ Termocouple, Compensating, Communication and Special Type Cables
- ✕ Cable Trays & Cable Ladders
- ✕ Medium Voltage & Low Voltage Cable Terminations, Joints, Glands, Shoes
- ✕ Earthing & Lightning Systems
- ✕ Medium Voltage & Low Voltage Instrument Transformers
- ✕ Low, Medium, High Voltage Post and Over Head Line Insulators
- ✕ Distribution Transformers
- ✕ Power Transformers
- ✕ Special Type Transformers
- ✕ Low voltage & Medium Voltage Switchgears
- ✕ Low & Medium Voltage Switchgear Equipments
- ✕ Low & Medium Voltage Earthing Resistors
- ✕ Low & Medium Voltage Power Capacitors
- ✕ Motor Soft Starters
- ✕ Power Generators
- ✕ Power Plant & Power Substation Equipments
- ✕ Power Plants, Substations, Switchyards, Special Type Silicone Insulation Paints
- ✕ Heat Insulation and Steril Paints
- ✕ Turbine, Generators, Transformer, Insulation, Engine Oils and Lubricants
- ✕ Low Voltage, Medium Voltage and High Voltage Power Line Towers
- ✕ Low Voltage, Medium Voltage and High Voltage Insulators
- ✕ Medium & High Voltage Surge Arresters
- ✕ Medium & Low Voltage Disconnecter Switch and Circuit Breaker
- ✕ Power Line Conductors
- ✕ Lead Acid, Lithium, Nickel Cadmium Batteries
- ✕ Battery Charger and Rectifier
- ✕ Un Interrupted Power Supply (UPS) and Inverters
- ✕ Lighting Poles
- ✕ Special Type Poles and Towers
- ✕ Indoor & Outdoor Lighting Equipments and Switching Accessories
- ✕ Pumps, Valves, Pipes and Fitting Equipments
- ✕ Air & Water Filters and Water Treatment Systems
- ✕ Air & Water Cooler Equipmet, Dry Fin Fan Coolers & Condensers
- ✕ Safety Shoes and Safety Equipments
- ✕ Marine Equipments and Paints



STEAM BOILERS, GENERATORS, BURNERS and HEAT EXCHANGERS

BURNERS

- 70-420 kW NATURAL GAS BURNERS
- 350 - 5800 kW NATURAL GAS BURNERS
- DUAL FUEL MONOBLOCK BURNERS
- 2.500 - 22.000 kW DUAL FUEL BURNERS
- FUEL OIL ROTARY CUP BURNERS
- DUAL FUEL ROTARY CUP BURNERS
- NATURAL GAS PROCESS BURNERS
- SPECIAL STENTER BURNERS
- GAS PROCESS BURNERS WITH SILICON CARBIDE HEAD
- TUNNEL TYPE NATURAL GAS BURNERS

• 70-420 kW NATURAL GAS BURNERS



• 350 - 5800 kW NATURAL GAS BURNERS



TECHNICAL SPECIFICATIONS

TYPE	CAPACITY kW		ELECTRICAL	GAS INLET DIAMETER	WORKING TYPE
	Min.	Max.			
DSC 6 -15	70	261	380	DN 15	AT 1 STAGE
DSC 15 - 30 S	150	300	380	DN 25	AT 1 STAGE
DSC 15 - 30	175	350	380	DN 25	AT 1 STAGE
DSC 20 - 40	200	420	380	DN 25	AT 1 STAGE

TYPE	CAPACITY kW		ELECTRICAL	GAS INLET DIAMETER	WORKING TYPE
	Min.	Max.			
DSC 6 - 15 K	70	261	380	DN 15	AT 1 STAGE
DSC 15 - 30 K	175	350	380	DN 25	AT 1 STAGE

WE HAVE THE RIGHT TO CHANGE OUR MEASUREMENTS.

TECHNICAL SPECIFICATIONS

TYPE	CAPACITY kW		ELECTRICAL	GAS INLET DIAMETER	WORKING TYPE
	Min.	Max.			
DSC 30 - 50	350	581	380	DN 32	AT 1 STAGE
DSC 30 - 50 L	350	700	380	DN 40	AT 1 STAGE
DSC 50 - 75	500	871	380	DN 40	AT 1 STAGE
DSC 50 - 75 L	550	1000	380	DN 40	AT 1 STAGE
DSC 50 - 100 S	580	1162	380	DN 40	AT 1 STAGE
DSC 50 - 100 L	580	1630	380	DN 40	AT 1 STAGE

TYPE	CAPACITY kW		ELECTRICAL	GAS INLET DIAMETER	WORKING TYPE
	Min.	Max.			
DSC 60 - 200 S	600	2000	380	DN 40	MODULATING
DSC 60 - 200 L	600	2500	380	DN 40	MODULATING
DSC 120 - 320 S	1200	3200	380	DN 50	MODULATING
DSC 140 - 350 S	1400	3500	380	DN 65	MODULATING
DSC 160 - 380 S	1600	3800	380	DN 65	MODULATING
DSC 160 - 380 L	1600	4400	380	DN 65	MODULATING
DSC 200 - 500 S	2000	5000	380	DN 80	MODULATING
DSC 200 - 500 L	2000	5800	380	DN 80	MODULATING

WE HAVE THE RIGHT TO CHANGE OUR MEASUREMENTS.

• DUAL FUEL MONOBLOCK BURNERS



TECHNICAL SPECIFICATIONS

TYPE	CAPACITY kW		ELECTRICAL	GAS INLET DIAMETER	CAPACITY kg/h		WORKING TYPE
	Min.	Max.			Min.	Max.	
DSC 50-100S FG	580	1162	380	DN 40	49	101	AT 2 STAGES
DSC 50-100L FG	580	1630	380	DN 40	49	142	AT 2 STAGES
DSC 60-200S FG	600	2000	380	DN 40	51	175	AT 2 STAGES
DSC 60-200L FG	600	2500	380	DN 40	51	219	AT 2 STAGES
DSC 120-320S FG	1200	3200	380	DN 50	104	280	AT 2 STAGES
DSC 140-350S FG	1400	3500	380	DN 65	122	308	MODULATING
DSC 160-380S FG	1600	3800	380	DN 65	140	334	MODULATING
DSC 160-380L FG	1600	4400	380	DN 65	140	388	MODULATING
DSC 200-500S FG	2000	5000	380	DN 80	175	441	MODULATING
DSC 200-500L FG	2000	5800	380	DN 80	175	512	MODULATING

WE HAVE THE RIGHT TO CHANGE OUR MEASUREMENTS.





2.500 - 22.000 kW DUAL FUEL BURNERS



TECHNICAL SPECIFICATIONS

TYPE	CAPACITY kW		CAPACITY kg/h		ELECTRICAL	GAS INLET DIAMETER	WORKING TYPE
	Min.	Max.	Min.	Max.			
RX 1	2000	6200	175	547	380	DN 80	MODULATING
RX 2	2500	7000	219	618	380	DN 80	MODULATING
RX 3	3600	11000	317	973	380	DN 100	MODULATING
RX 4	5600	16800	494	1487	380	DN 100	MODULATING

FUEL OIL ROTARY CUP BURNERS



TECHNICAL SPECIFICATIONS

TYPE	CAPACITY kW		CAPACITY kg/h		ELECTRICAL	GAS INLET DIAMETER	WORKING TYPE
	Min.	Max.	Min.	Max.			
RT 3	2500	6197	219	547	380	DN 80	MODULATING
RT 4	3000	9534	263	843	380	DN 80	MODULATING
RT 5	3600	11441	317	1012	380	DN 100	MODULATING
RT 6	5600	15255	494	1350	380	DN 100	MODULATING
RT 7	5600	22000	494	1948	380	DN 125	MODULATING

TECHNICAL SPECIFICATIONS

TYPE	MOTOR POWER		ELECTRICAL	LIQUID FUEL		CAPACITY kg/h		FUEL INLET
	Burner kW	Fan kW		Electrical Heater kW		Min.	Max.	
	RF 150	1,1	3	380	2	50	200	DN 15
RF 200	1,5	4	380	3	62	250	DN 15	
RF 300	2,2	7,5	380	5	95	380	DN 15	
RF 400	3	11	380	5	117	470	DN 15	
RF 500	4	15	380	5	157	630	DN 20	
RF 625	5,5	18	380	5	187	750	DN 20	
RF 800	7,5	22	380	5	200	800	DN 20	
RF 1000	7,5	22	380	7,5	250	1000	DN 20	
RF 1100	11	30	380	7,5	275	1100	DN 25	
RF 1250	11	30	380	7,5	312	1250	DN 25	

DUAL FUEL ROTARY CUP BURNERS



NATURAL GAS PROCESS BURNERS



SPECIAL STENTER BURNERS



GAS PROCESS BURNERS WITH SILICON CARBIDE HEAD

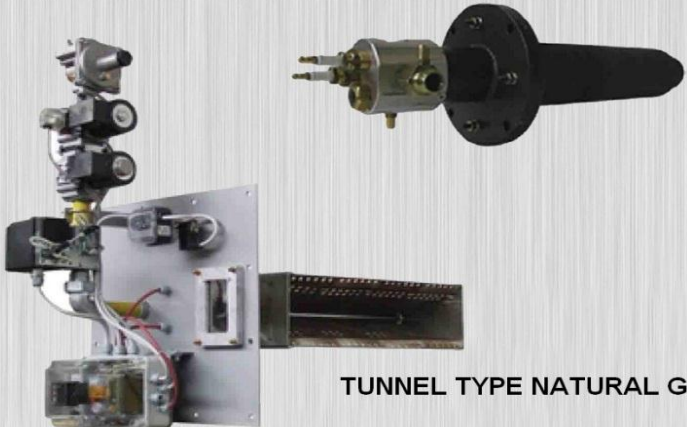

TUNNEL TYPE NATURAL GAS BURNERS



DISCOVERY

EVERYTHING FOR INDUSTRY & SERVICES



STEAM BOILER



DSC Steam boiler is used for heating and energy generation. The most important reasons of preference of steam are the following:

- A very efficient and good heat transferer.
- Heat transfer characteristics are high, especially in terms of phase changing.
- Transferring of steam is easy. Also steam is used for its humidification in some processes.

There -pass, fire-tube, gas or liquid fired Packaged Steam Boilers whose capacities are up to 15 t/h are commonly used in industry. As DSC himself produces combustion systems besides boilers, Compliance of Boiler & Burner and Thermal Efficiency are the highest level. We usually apply designs of lateral furnace and tube system in boiler plants. In this way, Heat transfer in the furnace is in perfect condition. Also Maintenance and cleaning of steam boiler is easy. Another important feature is that DSC furnaces are produced as corrugated. Thus, Their strength and resistance increase and Furnaces become flexible..

CONSTRUCTION:

- *With flat cambered Boiler plates and body which is pressure resistant.
- *Corrugated large furnace provides efficient combustion and low emission.
- *Optimum dimensioning of gas transfer pipes.
- *Large steam volume for quality steam.
- *Combustion Chamber.

MATERIAL:

The sheets of Boiler bod, front and rear plate of Boiler, furnace and combustion chamber are in accordance with DIN 17175 and have enough thickness. Also sheets of Boiler sections have the quality degrees of HI, HII, 17 Mn4. Boiler tube is accordance with DIN 17155 and it is manufactured as seamless, steel extrusion pipe whose quality is St.35.8 Completely corrugated furnace.

MANUFACTURING NORMS

Manufacturing is in compliance with european standarts, German TRD, CE, TUV, ISO, GOST, UKR, SEPRO, TS 377 norms.

FUEL

Brox Steam Boiler is perable with Fuel oil, Lpg, Natural Gas and Coal mainly. Brox Boiler are designed and manufactured in compliance with use of combined main fuels which are fuel-oil, Natural Gas, LNG and LPG.

BOILER EQUIPMENTS

- Boiler Body
- Furnace
- Second Pass Smoke Tubes
- Third Pass Smoke Tubes
- Combustion Chamber
- Front Smoke Box
- Rear Smoke Box
- Boiler Bearers
- Insulation
- Combustion System (Gas & Fuel Oil Burner)
- Steam Outlet
- Pressure Switch And Manometer Collector
- Water Inlet
- Feed Water Pump
- Collector
- Skimming
- Flange of Safety Valve
- Lifting Lugs
- Blowdown Valve

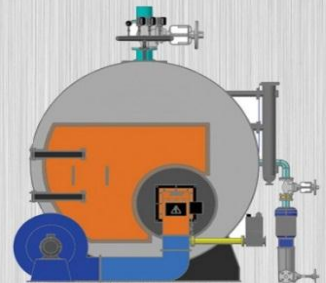
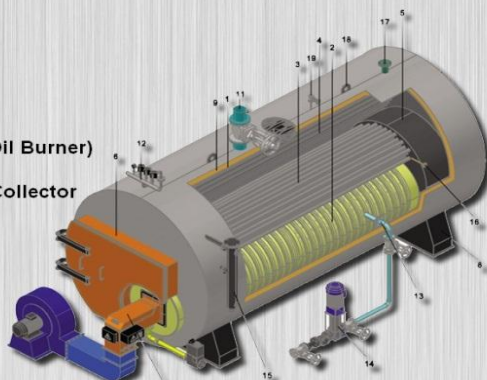



STEAM GENERATOR

STEAM GENERATOR TECHNICAL SPECIFICATIONS

MODEL	HEAT CAPACITY				DIMENSIONS						
	kg/h	Kw	mcal/h		A	B	C	D	E	F	G
200	200	140	120	1500		1150	150	200	1000	1000	347
400	400	280	240	1873		1500	150	220	1280	1000	347
600	600	420	360	1973		1600	150	320	1380	1143	347
800	800	560	480	2150		1677	250	350	1500	1250	350
1000	1000	700	600	2500		1677	300	350	1505	1500	350
1500	1500	1050	900	2523		2000	300	350	1505	1500	350
2000	2000	1400	1200	2773		2233	300	350	1660	1500	370
2500	2500	1750	1500	3040		2500	300	350	1700	1500	370
3500	3500	2442	2100	3640		3000	400	400	1900	2000	370
4500	4500	3140	2700	4682		4030	400	600	2256	2166	390
5000	5000	3490	3000	5152		4500	400	650	2256	2166	390
7000	7000	4885	4200	5152		4500	400	650	2256	2166	390
8000	8000	5582	4800	5652		5000	400	650	2256	2166	390

WE HAVE THE RIGHT TO CHANGE OUR MEASUREMENTS.

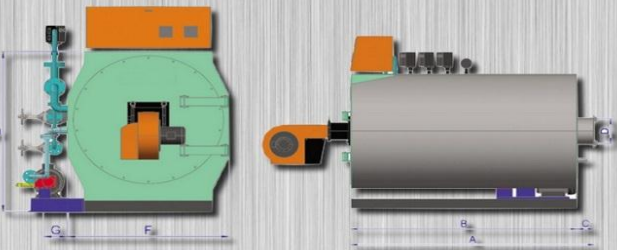

THERMAL OIL BOILER

EXHAUST HEAT BOILERS

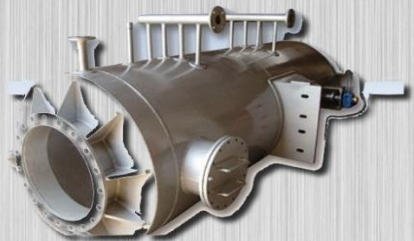

In many branches of industry, steam or superheated water is used as heat transfer fluids for attaining high temperatures, e.g 300°C degrees, in projects required high temperature operations. However, to a temperature of 300°C degrees can be reached up to with a pressure of 90 bar at least. Installation cost of the boiler plant working at very high pressures are high and risk of explosion of boiler increases. Thermal oil systems are used for meeting the requirement of high temperature fluid in industrial plants. The most important specification of thermal oil systems is to be able to rise to high temperature in low pressure values. Thermal Oil Boilers produce thermal energy effectively and safely at temperatures above 300°C degrees and under atmospheric pressure. These boilers are designed as two serpentine which are nested, three pass and accordance with in accordance with DIN 4754. Thermal Oils, specifications of which are able to remain intact nearly up to 300°C at the atmospheric pressure are used as heat transfer fluids. Boilers can be heated with fluid, solid and gas fuels. Heating surfaces of Thermal Oil Boiler in accordance with DIN 2448/17175 and these surfaces are manufactured from steel extrusion pipe, whose quality is in accordance with St 35.8.

Thermal Oil Boilers are insulated with rock wool, whose thickness of which is 100 mm to minimize heat loss and the rock wool is covered with embossed metal sheet, whose thickness of which is 0.8 mm.

- The Specifications of Thermal Oil Boiler:
- The temperature of oil can rise to 300°C at the atmospheric pressure.
- Thermal Oil doesn't cause any corrosion in the boiler plant.
- Also incrustation and calcification don't occur.
- In the normal climate conditions, Freezing doesn't occur in boiler plant.
- When necessary, hot water, boiling water and steam can be produced by means of thermal oil boiler.
- Temperature is checked easily.
- Boiler plant maintenance costs are low.



DISCOVERY

EVERYTHING FOR INDUSTRY & SERVICES



POWER CABLES LV, MV & HV

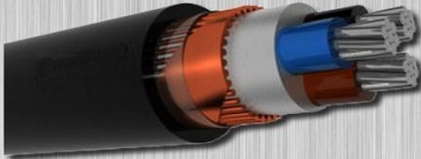

PVC INSULATED, FLAT CABLES WITH COPPER CONDUCTOR

<p>TWIN FLAT 6242Y 300/500 V BS 6004</p>	<p>Structure</p> <ol style="list-style-type: none"> 1- Solid or stranded copper conductor 2- PVC insulation 3- PVC outer sheath
<p>Technical Data</p> <p>Permissible operating temp: 70 °C Max short circuit temp: 160 °C Test voltage (AC): 2 kV Installation temp min: 5 °C</p>	<p>Application</p> <p>In dry and damp rooms, locations and store rooms where subjects to fire and explosions hazards but not for underground laying. For permanent installation clear from in and under plaster</p>

0,6/1 kV PVC INSULATED CABLES WITH COPPER CONDUCTOR



Structure

- 1- Solid or stranded copper conductor
- 2- PVC insulation
- 3- PVC filler
- 4- PVC outer sheath

YVV 0,6/1kV TS IEC 60502
 NYY 0,6/1kV VDE 0276-603

Technical Data

Permissible operating temp: 70 °C
 Max short circuit temp: 160 °C
 (+ 5 sec)
 Test voltage (AC): 2kV
 Installation temp min: 5°C

Applications

At power distributions stations, house hold premises, at industrial plants in cable ducts and pipes. Where there is risk of damages

0,6/1 kV PVC INSULATED, CONCENTRIC CONDUCTOR SCREEN, MULTI CORE CABLES WITH COPPER CONDUCTOR

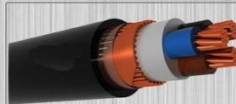

<p>YVCV 0,6/1 kV TS IEC 60502-1 NYCY 0,6/1 kV VDE 0271</p>	<p>Structure</p> <ol style="list-style-type: none"> 1- Solid or stranded copper conductor 2- PVC insulation 3- PVC filler 4- Concentric screen 5- Copper tape as binder 6- Polyester tape 7- PVC outer sheath
<p>Technical Data</p> <p>Permissible operating temp: 70 °C Max short circuit temp: 160 °C (+ 5 sec) Test voltage (AC): 3,5 kV Installation min: 5 °C</p>	<p>Applications</p> <p>Energy distribution network, street lighting system. Because concentric conductor acts as a fuse there is no risk of accident</p>



We as Discovery can supply all kind of LV, MV and HV power cables from Turkish and European manufacturers. Even short metrage quantity can be supply according to customer requirement. Please inform us your requirement via email or Fax. Also you can contact with our experienced staff by our phones
 Tel: +90 216 483 35 65 Fax: +90 216 483 35 26



DISCOVERY

EVERYTHING FOR INDUSTRY & SERVICES



INSTRUMENT, TERMOCOUPLE, COMPANSANTING, COMMUNICATION AND SPECIAL TYPE CABLES

Flexible Control and Tray Cables

UL: TC-ER, PLTC-ER, ITC-ER, MTW, DP-1, WTTTC 1000V, OIL RES
CSA: CIC-TC FT4, AWM I/II A/B FT4

TRAYCONTROL 500 & TRAYCONTROL 500-C
Flexible, highly oil-resistant (Oil Res I&II) control cable for exposed run (ER); gray jacket

TRAYCONTROL 600 & TRAYCONTROL 600-C
Flexible, oil-resistant (Oil Res I) tray cable for exposed run (ER); black jacket

Highly flexible Control Cables

UL: TC-ER, PLTC-ER, ITC-ER, MTW, DP-1, WTTTC 1000V, OIL RES I & II
CSA: CIC-TC FT4, AWM I/II A/B FT4
MULTIFLEX 600 & MULTIFLEX 600-C
Highly flexible, extremely oil-resistant cable for exposed run (ER)

VFD Cables

UL: TC-ER, PLTC-ER, ITC-ER, MTW, WTTTC 1000V, OIL RES I & II
CSA: CIC-TC FT4, AWM I/II A/B FT4

TOPFLEX® 600 VFD
Flexible, highly oil-resistant motor connection cable for exposed run (ER)

TOPFLEX® 650 VFD
Flexible, highly oil-resistant motor connection cable with control pair for exposed run (ER)

TOPSERV® 600 VFD
Highly flexible and extremely oil-resistant motor connection cable for exposed run (ER)

TOPSERV® 650 VFD
Highly flexible, extremely oil-resistant motor connection cable with control pair for exposed run (ER)

Data Cables

UL: PLTC-ER, ITC-ER, CM, OIL RES I & II
CSA: CIC-TC FT4, CMG

TRAYCONTROL 300 & TRAYCONTROL 300-C
Flexible, highly oil-resistant data and control cable for exposed run (ER)

TRAYCONTROL 300 TP & TRAYCONTROL 300-C TP
Flexible, highly oil-resistant data and control cable for exposed run (ER)

Single Conductors

FIVENORM
HAR: H05 V2-K/H07 V2-K
UL: MTW, AWM Style 10269
CSA: TEW, AWM I/A/B

THHN/THWM
CSA: MTW, THHN, THWN, GASOLINE, OIL RES II, AWM W-51554

Bus Cable
PROFInet Type A UL CMG, PLTC, CSA FT4
PROFInet Type B UL CMG, PLTC
PROFInet Type B SHIPLINE UL CMG, PLTC, CSA FT4
PROFInet Type C UL CMG
Profibus L2 Torsion UL CMX
Profibus L2 Festoon UL CMX, CSA FT4
Profibus SK inside UL CMG, CSA FT4
Profibus SK FRNC UL CM
Profibus SK drag chain UL CMX
DeviceNet™ PVC small UL CMG FT4
DeviceNet™ PVC thick UL CMG FT4

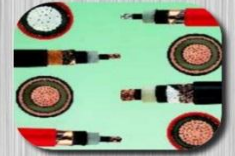

Cables for drag chain Water resistant
Water resistant Servo, feedback and motor cables
Flexible control cables Trailing cables
Data and computer cables Single conductors
Heat-resistant cables Coaxial cables
Flat and ribbon cables Installation cables
Telephone and fire warning cables Power cables, security cables
and medium voltage cables
Allweather and rubber cables Shipwiring and marine cables
Pre-assembled cables Spiral cables
Cables according to international approvals



WK-Series
Trailing cables
Cables for renewable energy
Sensor/actuator cables
Airport 400Hz
Truck cables

LAN and WAN Networks have steadily increased in importance as the backbone of company's communication system. Discovery offers an extensive range of equipment for networking heterogeneous systems using fibre optic and copper techniques. Products developed by us for passive applications, and active components from well-known manufacturers form the basis of our portfolio.



Cable glands, plastic
Cable glands, metal
Gland fittings
Cable protection tube systems
Tube glands
Tube fittings
Insulating, shrunk, braided and high temperature tubes
Shrunk tubes and end caps
End closures, coupling sleeves Bundling, binding, fastening
Identification and marking
Core end sleeves and cable lugs
Tools



DISCOVERY

EVERYTHING FOR INDUSTRY & SERVICES



CABLE TRAYS

- Normal Type Cable Trays
- Heavy Duty Type Trays
- Universal Type Cable Trays
- Cable Tray Covers
- Cable Ladders
- Cable Ladder Covers
- Trellis Cable Trays
- Pipe Systems
- C Profiles
- Support Systems
- Marine Type Cable Trays
- Marine Type Cable Ladders
- Underfloor Cable Trays
- Earthing Systems

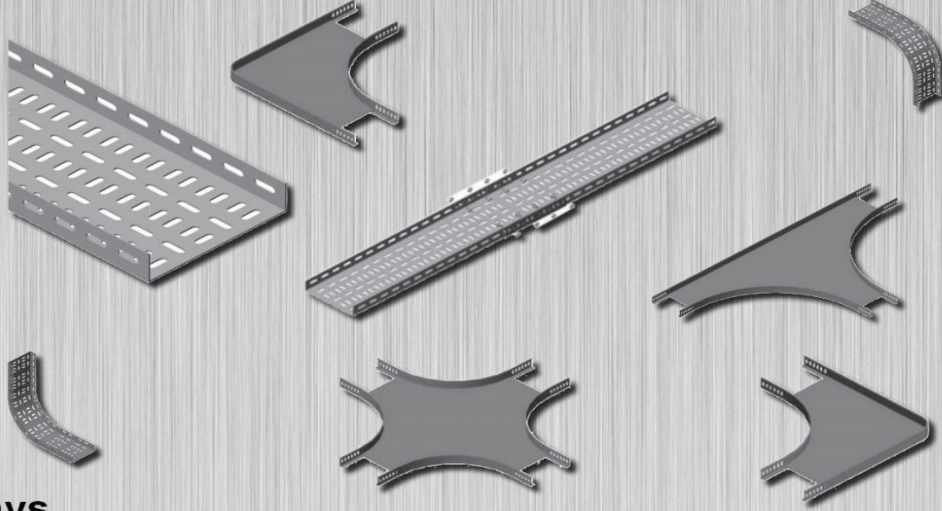

Heavy Duty Type Trays

The difference of this serie from Normal Type is the 8mm concave and circular bending in the edges of the tray. This application increase the strenght and carrying capacity of the products. It also helps to reduce product and labor costs.

This serie of cable trays are manufacturing with 50, 100, 150, 200, 250, 300, 400, 500 and 600mm widths, 40, 50 and 60mm heights, 0,80 / 1,00 / 1,20 / 1,50 and 2,00mm thicknesses.

Moreover, you can easily change the direction of the 2500 mm and 3000 mm lenghted trays with the assistance of modular turn and bends

Coating Type:

Hot Dip Galvanized ISO EN 1461 (TS 914)

Pre-galvanized ISO EN 10143 (TS 822)

Electrostatic Paint (All RAL Codes)



CABLE TRAYS & CABLE LADDERS

Marine Type Cable Trays

This serie of cable trays are manufacturing with 50, 100, 150, 200 and 250 mm widths, 15, and 30 mm heights, 1,00 / 1,50 thicknesses.

Moreover, our standard lenght for this type of products is 3000 mm

Coating Type:

Hot Dip Galvanized ISO EN 1461 (TS 914)

Pre-galvanized ISO EN 10143 (TS 822)

Electrostatic Paint (All RAL Codes)

PLEASE DONT HESITATE TO CONTACT WITH US FOR YOUR SPECIAL TYPE CABLE TRAYS, LADDERS REQUIREMENTS WE CAN PREPARE PROJECT AND PRICE QUOTATION

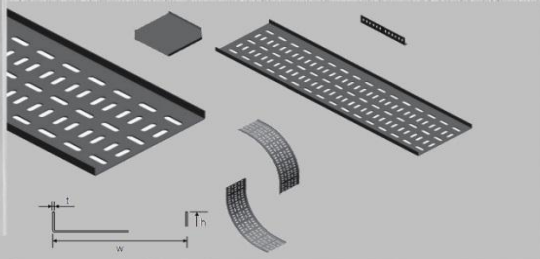

Marine Type Cable Ladders

This serie of cable ladders are manufacturing with 50, 100, 150, 200, 250 and 300mm widths, 40 and 50 mm heights, 5,0 mm thicknesses.

Moreover, our standard lenght for this type of products is 3000 mm

Coating Type:

Hot Dip Galvanized ISO EN 1461 (TS 914)

Pre-galvanized ISO EN 10143 (TS 822)

Electrostatic Paint (All RAL Codes)

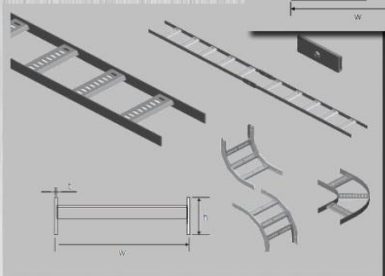

Underfloor Cable Trays

This type of cable trays are generally used in indoor areas like offices, for protecting, distributing and grouping of communication and energy systems with suitable designs for all settlement plans. On the other hand, you can easily put plug exits on the cable trays with the underfloor junction boxes.

Coating Type:

Pre-galvanized ISO EN 10143 (TS 822)



Earthing Systems

This serie inclues all type of galvanized conductors and accessories for earthing installations.

Galvanized Earthing Strip "Coil"



Galvanized Earthing Strip



Connection Clamps

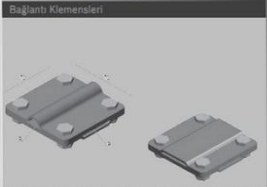

Galvanized Vertical Connection Parts



Galvanized Horizontal Connection Parts

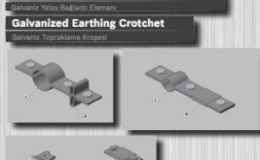

Galvanized Earthing Crotchet



Equipotential Busbar (Galvanized)

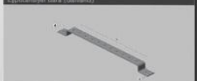

Equipotential Busbar (Copper)



Galvanized Mono Wire



Galvanized Earthing Electrode



Galvanized Earthing Electrode (Angle Type)

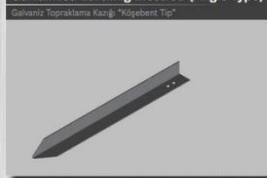

Brass Fixing Connectors



Equipotential Busbar (Copper)



Equipotential Busbar (Tinned)

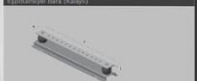



CABLE TERMINATION, CABLE JOINTS, INSULATION TAPES (FROM 1kV UP TO 40,5kV)



DISCOVERY FOREIGN TRADE COMPANY CAN SUPPLY FROM STOCK WELL KNOWN EUROPEAN & TURKISH BRANDS MANUFACTURERS PRODUCTS. IN OUR SCOPE OF RANGE HEAT SHRINKABLE & COLD SHRINKABLE CABLE TERMINATIONS AND JOINTS AND ALSO COLORED INSULATION TUBES & INSTULATION TAPES ARE EXIST IN OUR STOCK. PLEASE CONTACT WITH US TO GET MORE DETAIL AND CHECK STOCK STATUS.

HEAT-SHRINKABLE CABLE JOINT FOR NYY-NYCY CABLES

Application
Heat-shrink joints are used for cable joints and for thermoplastic insulated 1 kV power cables ocaution under mechanical stresses, underground, in power and switching stations, Industrial plants.

Technical Data
Cable joints are carried out by means of heat-shrink tubings, insulated live parts, protection cables, elements and are applied by means of devices which has a good protection against mechanic damages, hot and alkaline environment. The system is based on the well proved concept of heat-shrinkable plastic sleeving internally lined with adhesive which conforms with jointed cable on application of a hot air gun of flame torch.

Mounting
Mounting of cable joint should be done according to the factory's mounting instructions.



HEAT-SHRINKABLE CABLE JOINT FOR SINGLE CORE CABLES

Application
Cablejoints are used for jointing ofsingle core insulated cables(PE, XLPE, EPDM) with radial field for voltage 3.5-6,5.8-10, 8.7-15 kV. Technical Data The straight joint consist of a silicone rubber sleeve which incorporates the conductor connector radial-field deflector. Sealing tapes at the ends of cable sheaths ensure an efficient seal against penetration of water in longitudinal direction. Copper braid tape for metallic screening. The heat-shrinkable tube is made of crosslinked polyolefine with internal hot melt adhesive coating to provide an outer protective cover.

Mounting
Mounting of cable joint should be done according to the factory's mounting instructions.





CABLE GLANDS & CABLE SHOES



- DIN 46320-DIN 50262
- Leakageproof value: IP-68
- Heat resistivity: Continuously (-40 C +120 C)
- Material: MS 58 Brass
- It can be produced with nyckel-electro plated
- Various sizes can be produced if ordered

- DIN 46320-DIN 50262
- Leakageproof value: IP-68
- Heat resistivity: Continuously (-30 C +120 C)
- Material: Poliamid-6 with special additives
- Color: Grey (Standard), Black, Blue, Light Grey, Cream Colored (If ordered)

- DIN 46320-DIN 50262
- Leakageproof value: IP-55
- Heat resistivity: Continuously (-40 C +120 C)
- Material: MS 58 Brass
- It can be Nickel-Electro plated
- Various sizes can be produced if ordered

- DIN 46320-DIN 50262
- Leakageproof value:IP-55
- Heat resistivity: Continuously (-40 C +120 C)
- Material: MS 58 Brass
- If ordered, it can be nickel electro plated
- Various sizes can be produced if ordered

- Exproof Cable Gland
- Certificate: TSE-Ex
- Standards: EN 50014/50018 (EEx d II A/B/C)
- Material: MS 58 Brass
- Production Types: CW, E1W, A2, BWL



IP-68 POLIAMID CABLE GLAND



IP-68 BRASS CABLE GLAND



NORMAL BRASS CABLE GLAND



CABLE GLAND WITH LOCKER



EXPROOF CABLE GLAND



NORMAL CABLE TERMINALS



HEAT RESISTIVE CABLE TERMINALS



GROUNDING CABLE TERMINALS



POLIAMID BUNDSTOP



POLIAMID NUTS



BRASS BUNDSTOP



BRASS NUTS



ANY KIND OF CABLE AND INDUSTRIAL GLANDS, SHOES, LUGS AND TERMINALS CAN BE SUPPLY FROM STOCK OF WELL KNOWN EUROPEAN AND TURKISH BRAND MANUFACTURERS PLEASE FEEL FREE TO CONTACT WITH US FOR AVAILABLE STOCK PRODUCTS AND INFORM US FOR YOUR SPECIAL GLANDS REQUIREMENT. AND ALSO PRIVATE LABEL CAN BE POSSIBLE ACCORDING TO QUANTITY OF INQUIRY

CABLE SHOES & LUGS





DISCOVERY

EVERYTHING FOR INDUSTRY & SERVICES



EARTHING & LIGHTNING SYSTEMS AND MATERIALS



ETS9, ETS12, ETS13



ESDK



ESK55



ESK



ESKB-SD



ESK-SD



ESDKV



ESK-SD



EDTBT

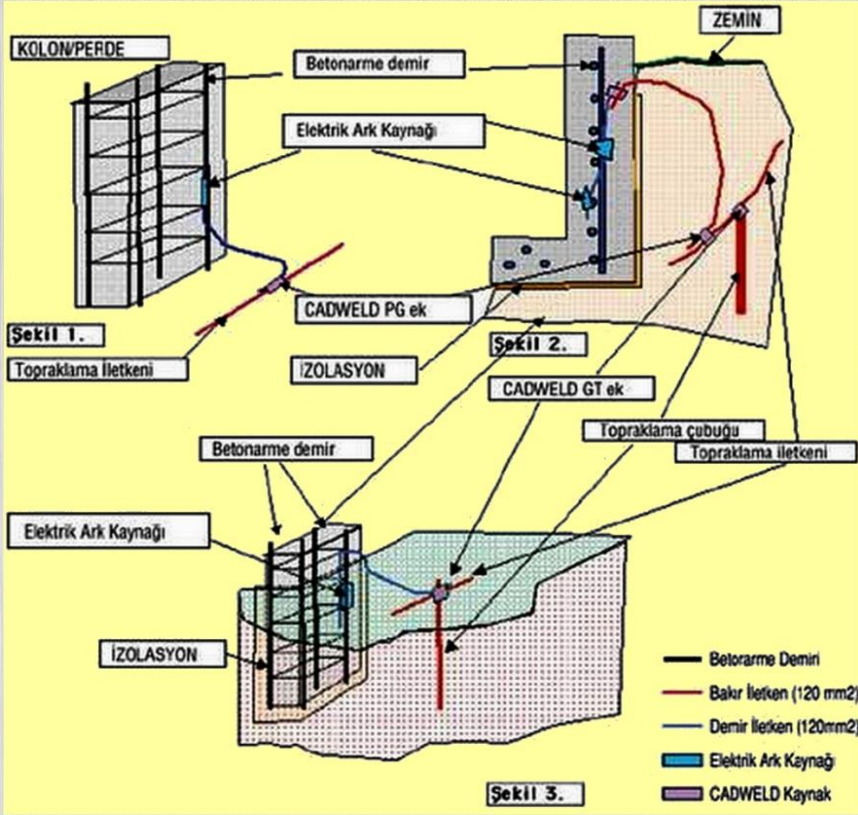

PLEASE SEND US YOUR INQUIRY ANY KIND OF YOUR EARTHING & LIGHTNING REQUIREMENTS. WE WILL PREPARE OUR QUOTATION FROM WELL KNOWN AND FAMOUS TURKISH & EUROPEAN MANUFACTURERS. PLEASE DON'T HESITATE TO CONTACT WITH US FOR YOUR SPECIAL REQUIREMENT. IT WILL BE OUR PLEASURE TO BE YOUR SOLUTION PARTNER WITH OUR EXPERIENCED DESIGNING AND ENGINEERING STAFF.





MEDIUM VOLTAGE & LOW VOLTAGE INSTRUMENT TRANSFORMERS (CURRENT TRANSFORMERS & POTENTIAL TRANSFORMERS)

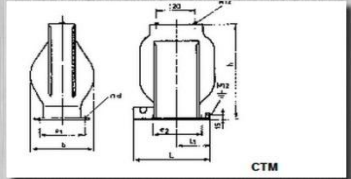

CURRENT TRANSFORMER

Type	kV	P. Current max. A	Ther. Curr. max. kA	Weight kg	b	e1	e2	d	h	L1	L	m	n
CTM 20	3.6 - 24	1500	80	18	190	150	150	14	260	95	235	190	225
CTM 30-1	38	1500	80	25	220	150	150	14	360	95	235	270	285
CTM 30-2	38	1500	80	40	220	180	170	14	390	125	280	270	285
CTM 30-3	38	1500	80	50	240	205	280	14	390	160	335	270	285
CTB 10-1	3.6-17.5	2000	80	20	148	120	300	14	220	165	385	190	225
CTB 10-2	3.6-17.5	2500	80	25	178	150	300	14	220	165	385	190	225
CTB 20-1	12-24	2000	80	25	178	150	300	14	260	165	385	190	225
CTB 20-2	12-24	2500	80	35	178	150	300	14	280	165	385	190	225
CTB 30	38	2500	80	50	220	190	300	14	370	170	385	270	285

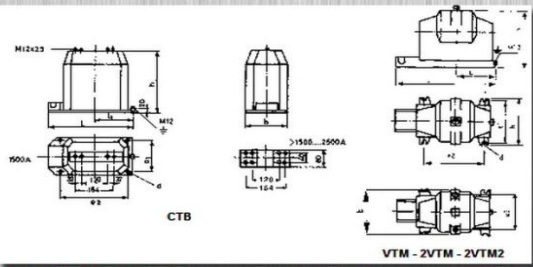
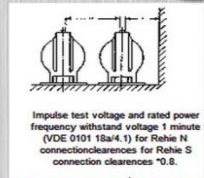

VOLTAGE (POTENTIAL) TRANSFORMER

Type	kV	Accuracy Class Rating 1. windings	z windings	Ther. Ratings VA	Weight kg	b	e1	e2	e3	h	L1	L	m	n
VTM 10	3.6 - 24	0.5	120	400	35	220	170	270		300	185	410	90	120
VTM 20	17.5-24	15	80	600	38	220	150	270		300	185	410	200	220
VTM 30	30	30	80	800	50	200	170	270		390	180	405	285	315
2VTM 10	3.6-12	20	80	400	35	250	280	270	210	300	185	410	115	115
2VTM 20	17.5-24	20	80	600	38	250	300	270	210	300	185	410	190	200
2VTM 30	30	30	80	800	60	370	300	270	320	390	190	430	340	380
2VTM 20-2	3.6-24	15	80	800	1000	40	250	300	270	210	300	185	410	190
2VTM 30-2	30	15	80	800	1000	65	370	300	270	320	390	190	430	340

LOW VOLTAGE CURRENT TRANSFORMER

TOROIDAL CURRENT TRANSFORMERS



Technical data:
 Rated primary current 5.....5000 A
 Class of accuracy: 0.5 ; 1 ; 3
 Rated voltage: 600V
 Rated secondary current: 5A (or 1A on request)
 Security factor: FS 5
 Burden VA : 5 ; 10 ; 15 ; 30
 Working temperature range: -20 to + 55 oC
 Nonflammable ABS plastic case, totally enclosed; built-in cover
 Rated frequency: 50/60 Hz
 Types :MSQ-A ;MSQ 30A ;MSQ 30T ; MSQ 30; MSQ 40 ; MSQ60 ; MSQ 100

Toroidal Current Transformers Specifications:

- 1-Primary rated current : 50A5000A
- 2-Standart Voltage: 0,72 kV
- 3-Secondary rated current: 1-1,5-2-5 A
- 4-Burden : 5400 VA
- 5-Frequency: 50 /60 Hz
- 6-Insulation : wound pvc band or paper
- 7-Protection or measuring use
- 8-We produce according to the specifications of customer requirement



9-We follow the standards TS 620, IEC 44-1, ANSI C. 57-13
 Supporting current instrument transformers are designed for the measurement and protection of the distributing facilities of high voltage for inner settings. Supporting current instrument transformers are arranged for the using in the Switchgear Manufacturers. The value of the secondary current is 5 A or 1 A with the possibility of combination. The classes of accuracy for the circuits of measurement are 0.2, 0.5, 1.3, for the circuit of protection are 5P, 10P. The transformers comply with the required class of accuracy within the values from 25% to 100% of rated load. The limiting working current is 120% of IN according to the agreement of producer and customer it is possible to supply other values, for example 200% of IN. Transformers types are constructed as transformers with single-turn or multi-turn primary winding. The up-to-date construction of these transformers allows the switching not only on the secondary side but also on the primary one. The primary switching can be easily mounted by the means of connection of two jumpers to the circuit by the means of two screws M8. The secondary winding is wound on the magnetic core made of directed plates, eventually made of the alloy of nickel, iron and copper "permalloy". The number of cores can be from 1 to 3 according to the request of customer. All active parts of transformer are compound-insulated with epoxy-mixture. This material performs both the electrical insulating and the mechanical functions.



The transformers types in distributors VH-IRODEL we produce and supply epoxy adapter, pin and special basic plate. In cases, where the supplement for the older types of transformers (by various producers) is required, we supply instruments CTS on the modified basic plates that have identical mounting spacing to spacing of the substituted types. Transformers CTS complied with all the tests according to CSN EN 6044-1.

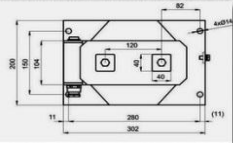
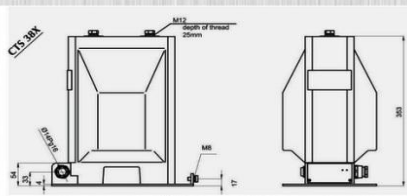



DISCOVERY

EVERYTHING FOR INDUSTRY & SERVICES



LOW VOLTAGE, MEDIUM VOLTAGE & HIGH VOLTAGE POST AND LINE INSULATOR (EPOXY RESIN, COMPOSITE, SILICONE, PORCELAIN & GLASS INSULATORS)

These insulators are used for low voltage overhead distribution lines to fix the conductors to the post bodies. This group of insulators includes of low voltage insulators standardized in accordance with TSE, DIN and ANSI specifications. These insulators are divided into mainly three in accordance with types:

- *Pin type insulators
- *Line post insulators
- *String Insulators
- *Long-Rod Insulators
- *Railway insulators
- *Low voltage insulators



- PIN type insulators DIN norms.
 - Shackle and spool insulators in accordance with DIN and ANSI norms.
 - String insulators in accordance with ANSI norms.
 These insulators are made of hard porcelain KER 110-1
 Other types of insulators which are not covered by this catalogue, can also be produced upon customer's request.



SILICONE & POLYMER COMPOSITE INSULATORS

These types composite insulators used in medium voltage distribution power lines. These insulators are preferred because of their advantages, areas close to the sea and industrial pollution in regions of high hydrophobic properties to the high insulation to provide better, be impenetrable type, easy assembly, according to the porcelain insulator and glass insulator to the lighter. Kaleseramik is producing composite insulators with pure LSR (liquid silicon rubber) silicone. All design and type test of Kaleseramik composite insulator products are testing international accredited laboratories according to IEC61109 AND IEC62217 standarts. Not included in our web site, with different service voltage levels and higher creepage distance insulators can be also manufactured customer's requirements.

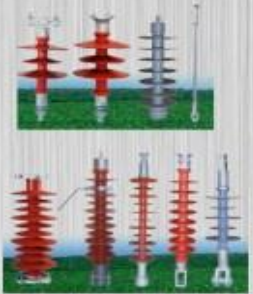

EPOXY INSULATORS

Tests
 The following tests, according to IEC 60660 - 1990 are performed:

- Routine tests**
- Visual inspection
 - Testing of conductive connection of fixing inserts for post insulators type B (IEC 60660 1999)
 - Power-frequency withstand voltage (dry)
 - Partial discharge measurement

- Sample tests**
- Testing of minimum failing load for bending

- Additional tests**
- Lightning impulse withstand voltage test (on request)
 - Testing of minimum failing loads (nominal loads) for bending

Application

Epoxy cast resin indoor post insulators can be used for all indoor applications. For tropical conditions same types (with special fixing parts) are available. They are suitable for temperatures from -25°C up to +90 °C

Construction

Epoxy cast resin indoor post insulators are cylindrical solid insulators, with proper creepage and number of ripples. The main dimensions are in accordance with IEC 60273 - 1990. Auxiliary inserts are connected with main insert electrically.



TOUGHENED GLASS INSULATORS

We can supply Medium Voltage & High Voltage toughened glass insulators from east European countries manufacturer by way of our sales offices in east European countries.





DISCOVERY

EVERYTHING FOR INDUSTRY & SERVICES



POWER, DISTRIBUTION, COMPENSATION & SPECIAL TYPE TRANSFORMER

Discovery Foreign Trade Co. can supply all the famous European, USA, Canadian, Turkish and Far East Origin Transformer according to customer requirement. Transformer calculation according to customer project can be done by our expert engineer team.

Distribution transformers from 25 kVA to 5000 kVA and power transformer from 4000 kVA to 35000 kVA with both voltage side from 3,3 kV to 36 kV. Discovery Foreign Trade Co. exports quality transformers wide range of all Middle East and African countries.



Oil filled power transformers from 4 MVA to 35 MVA with both voltage side from 3,3 kV to 36 kV, provided with off-load or on-load tap changers, with cooling methods ONAN or ONAN/ONAF.

They are produced according to customer request or contract and mentioned standards which are TS 267, IEC 60076, DIN, ANSI, BS171. Each transformer is dispatched after performing routine tests according to TS 267 and IEC 60076 standards. Also type tests and special tests according to same standards are performed at our laboratories by customer request.

HIGH VOLTAGE AND MEDIUM VOLTAGE HIGH POWER RATED POWER & DISTRIBUTION TRANSFORMER ALREADY EXIST IN OUR SCOPE OF RANGE PLEASE DON'T HESITATE TO SEND ANY OF YOUR INQUIRY



DISCOVERY

EVERYTHING FOR INDUSTRY & SERVICES



LOW AND MEDIUM VOLTAGE

METAL CLAD, METAL ENCLOSED, G.I.S & R.M.U SWITCHGEARS AND SWITCHBOARDS

MEDIUM VOLTAGE METAL CLAD AIR INSULATED SWITCHGEAR

Metal Clad Switchgear line is a completely factory assembled integration of draw out switching devices ,bus, protective and control devices coordinated electrically or mechanically for MV distribution and protection. Metal Clad Switchgears are consist of 3 main and 1 auxiliary compartment which are separated between each other by metal plates, with its own MV switching device

Application Areas : Energy Generation and Distribution Facilities, Transformer Stations, Mines, Cement Industry, Petro -Chemical Industry, Coal Iron and Steel Industry, Pump Stations, Airports, Ports, Railways, Large Scaled Shopping Malls, Hotels, Business Centers, Hospitals, etc.



Suitable brand will be chose according to customer requiremend, project, for more information about dimensions & technical specification please contact with usand give us information for the brand of circuit breaker and your required origin we will choose suitable product from our manufacturers





DISCOVERY

EVERYTHING FOR INDUSTRY & SERVICES



LOW AND MEDIUM VOLTAGE METAL CLAD, METAL ENCLOSED, G.I.S & R.M.U SWITCHGEARS AND SWITCHBOARDS MEDIUM VOLTAGE METAL CLAD AIR INSULATED SWITCHGEAR



Applicable Standards
 HMS switchgears fully comply with the following international standards:
 ** IEC 62271-100 for circuit breakers
 ** IEC 62271-200 for switchgears
 ** IEC 60470 for contactors
 ** IEC 60694 for general purposes
 ** IEC 62271-102 for earthing switches

Design Concepts

Metal Clad Switchgears have been designed, manufactured, and type tested in line with our quality assurance program and IEC standards, ensuring:

- ** Maximum safety and reliability
- ** A minimum of maintenance, with all parts easily accessible
- ** A simple but flexible design
- ** Panels resistant to internal arc faults
- ** Switchgear modules with integrated interlocking and control boards.
- ** Circuit breakers, controls and switch-disconnector panels can be lined up.
- ** Easy installation

Incoming VCB Feeder Panel

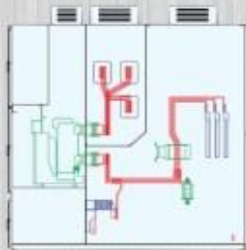

Outgoing VCB Feeder Panel



Bus Tie Panel

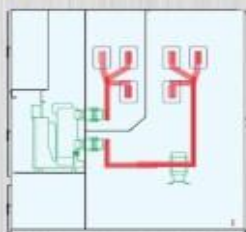

Bus PT Panel

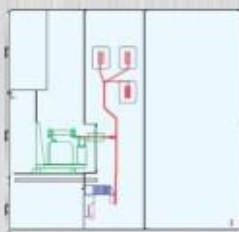



DISCOVERY

EVERYTHING FOR INDUSTRY & SERVICES



LOW AND MEDIUM VOLTAGE

METAL CLAD, METAL ENCLOSED, G.I.S & R.M.U SWITCHGEARS AND SWITCHBOARDS

MEDIUM VOLTAGE METAL ENCLOSED MODULAR , G.I.S. AND RMU SWITCHGEARS



Gas Insulated Switchgear (Compact)

Designed for up to 36 kV systems as Ring Main Unit – RMU.

All switching and connection equipments are in a stainless steel tank which is filled with SF6 gas. Required type test for the safety of the operator and the facility have been applied to the switchgears which passed the tests successfully. Energized parts are isolated in IP 67 protection degree in case of any accidental touch against the dust, humidity, torrent and etc. They are manufactured at smaller sizes by using load break switch with SF6 gas. SF6 gas is used inside RMU for insulation and to extinguish the arc. Our Metal Enclosed SF6 Gas Insulated Compact Switchgear - Ring Main Units are ready for SCADA applications with GE General Electric protection and control relays. Our Ring Main Units are manufactured according to the relevant international and national standards like as IEC 60298, IEC 62271-200, BS EN 60298, TS EN 60298 to cover the request of customers with easy configurable and several types. It offers a choice of either a load break switch fuse combination or vacuum circuit breaker with relay protection of the customer. It can be designed with different configurations to apply customer requirements. A sealed stainless steel tank with constant atmospheric conditions ensures a high level of reliability as well as personal safety and virtually maintenance free system called no maintenance. It can be supplied in different configurations and combinations suitable for switching applications. It can be extensible and combined with the our Metal Enclosed SF6 Gas Insulated Modular Switchgears.



Air Insulated Switchgear

Designed for up to 36 kV systems. Required type test for the safety of the operator and the facility have been applied to the switchgears which passed the tests successfully. They are manufactured at smaller sizes by using load break switch with SF6 gas, rotary disconnector switch and disconnector switch with SF6 gas. SF6 gas is used inside the circuit breaker and load break switch for insulation and to extinguish the arc. All the other parts are in air medium. Our Metal Enclosed Air Insulated Switchgears are ready for SCADA applications with GE General Electric protection and control relays. Our switchgears are manufactured according to the relevant international and national standards like as IEC 60298, IEC 62271-200, BS EN 60298, TS EN 60298 to cover the request of customers with modular types, easy configurable and several types. It is also possible to make revisions, additions or modifications of the configuration for later requirements. Switchgears can be replaced with another functional unit easily. Connection between switchgears is made with tubular bus-bars. In standard manufacturing; nominal currents of bus-bars are 630 A or 1250 A according to customer requests.

- Full gas-insulation, providing protection against harsh environmental elements (including flooding), long service life and maintenance-free of live parts.
- Complete modularity and future extendibility, in both sides using the connecting set.
- Personal, property and equipment protection: internal arc withstand, in accordance with IEC 60298.
- Reduced size and weight, for easy handling and installation.
- Safe and simply operation, highly ergonomic operation components and additional interlocks included.
- Possibility of assembling accessories and performing tests under voltage.
- Front access, gas-insulated, horizontal fuse holder.
- Easy cable connection, with plug-in or screwed terminals.





DISCOVERY

EVERYTHING FOR INDUSTRY & SERVICES



LOW VOLTAGE SWITCHBOARDS AND PANELS



Floor Standing Switchboard Enclosures (IP 55)

- Prefabricated and modular structure (Enclosures can be bayed side by side or back to back to form required combination)
- Zinc coated framework (4 vertical, 8 horizontal and special corner parts)
- High mechanical endurance
- Zinc coated and epoxy polyester powder painted doors and outer panels (Sealed with PU gasket)
- IP 55 Protection
- Large mounting component area. Versatile design which allows the user to fix components at 25 mm intervals either horizontally or vertically
- Rich and multi-functional mounting components



Monoblock Switchboard Enclosures (IP 66)

- Monoblock rigid body
- High mechanical endurance
- Epoxy polyester powder painted body and door (Sealed with PU gasket)
- Zinc coated mounting accessories
- IP 66 High protection
- Functional mounting components



1- Monoblock Console

- Welded monoblock rigid body
- High mechanical endurance
- Zinc coated and epoxy polyester powder painted body and door (Sealed with PU gasket)
- Zinc coated mounting accessories
- IP 55 protection
- Rich and multi-functional mounting components



2- Modular Console

- Prefabricated and modular structure (Consoles can be bayed side by side to form required combination)
- Zinc coated framework (4 vertical, 8 horizontal and special corner parts)
- High mechanical endurance
- Zinc coated and epoxy polyester powder painted desk section, doors and outer panels (Sealed with PU gasket)
- IP 55 Protection
- Large mounting component area. Versatile design which allows the user to fix components at 25 mm intervals either horizontally or vertically
- Rich and multi-functional mounting components



3- Monitor Type Console

- Prefabricated and modular structure (Consoles can be bayed side by side to form required combination)
- Zinc coated framework (4 vertical, 8 horizontal and special corner parts)
- High mechanical endurance
- Zinc coated and epoxy polyester powder painted desk & monitoring section, doors and outer panels (Sealed with PU gasket)
- IP 55 Protection
- Large mounting component area. Versatile design which allows the user to fix components at 25 mm intervals either horizontally or vertically
- Rich and multi-functional mounting components



Junction Box (IP 67)

- Ideal for local distribution or/and cable junction applications which especially require high protection level.
- Monoblock rigid body
- High mechanical endurance and protection level for hard conditions (dusty and humid)
- Epoxy polyester powder painted body and door (Sealed with PU gasket)
- Zinc coated mounting plate
- IP 67 High protection



Outdoor Switchboard Enclosures (IP 55 - IP 66)

- Prefabricated structure
- Zinc coated framework (4 vertical, 8 horizontal and special corner parts)
- High mechanical endurance
- Zinc coated and epoxy polyester powder painted doors, roof module and outer panels (Sealed with PU gasket)
- IP 55 Protection
- Large mounting component area. Versatile design which allows the user to fix components at 25 mm intervals either horizontally or vertically
- Rich and multi-functional mounting components



Stainless Steel Switchboard Enclosures (Modular) & Consoles (IP 55)

- Prefabricated and modular structure (Enclosures can be bayed side by side or back to back to form required combination)
- Stainless Steel framework (4 vertical, 8 horizontal and special corner parts)
- High mechanical endurance
- Stainless Steel doors and outer panels (Sealed with PU gasket)
- IP 55 Protection
- Large mounting component area. Versatile design which allows the user to fix components at 25 mm intervals either horizontally or vertically
- Rich and multi-functional zinc coated mounting components





MOTOR SOFT STARTERS



Voltage Range 220 – 15 000 V | Current Range 1 – 3 500 A

- Medium voltage soft starters
- Low voltage soft starters
- Variable frequency drives
- EMC-technology
- Medium voltage contactors
- Low voltage contactors
- Vacuum circuit breakers

INTERIOR VIEW ISA-HD

This third generation, fibre optic controlled, Medium Voltage Soft Starter is designed for use with standard asynchronous and synchronous motors. The ISA-HD is a highly sophisticated digital soft starter which ensures smooth, stepless acceleration and deceleration, eliminating current and mechanical shocks on motor and load. The ISA-HD may be supplied as a chassis or enclosed type with a multiple range of options.

- Options**
- | Motor protection relay (MSR-HD)
 - | High protection level (IP54)
 - | RS 485 Modbus or Profibus
 - | Analogue output
 - | Cabinet heater
 - | Incoming cabinet with fuses or circuit breaker
 - | Special parameters for synchronous motors
 - | Multi motor start
 - | Marine approvals

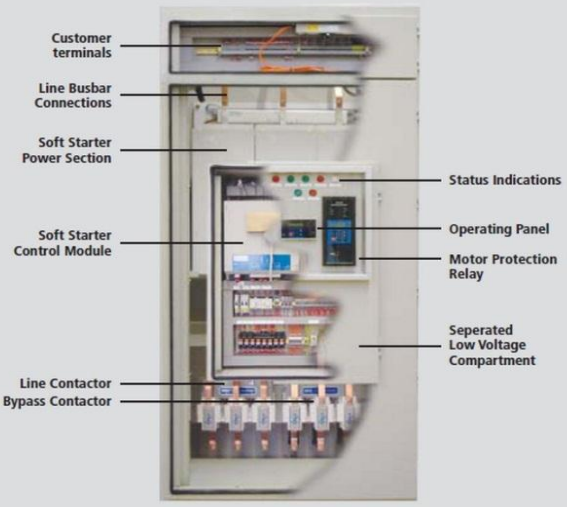

MEDIUM VOLTAGE SOFT STARTERS	Medium voltage technology ISA-HD
LOW VOLTAGE SOFT STARTERS	Low voltage technology ISA-D and ISA-D5 ISA-A and ISA-A2P ISA-B and ISA-B2P
VARIABLE FREQUENCY DRIVE	ISA-DRIVE-VT ISA-DRIVE-PLUS ISA-DRIVE-E ISA-DRIVE-B and ISA-DRIVE-F
DC INJECTION BRAKE	IMB
THYRISTOR POWER SUPPLY	TSE
EMC-TECHNOLOGY	Line filters Line chokes
CONTACTORS	Contactors and motor protection relays Vacuum contactors and circuit breaker
SWITCHGEAR SOLUTIONS	Special solutions; medium voltage OEM serial production; low voltage





DISCOVERY

EVERYTHING FOR INDUSTRY & SERVICES



POWER GENERATORS



Standby Power

Standby power is defined as the maximum power available during a variable electrical power sequence, under the stated operating conditions, for which a generating set is capable of delivering in the event of a utility power outage or under test conditions for up to 500 hours of operation per year under average of 70% load. Overloading is not permissible.

Our Company is able to supply low and Medium Voltage Power Generator with the famous brands of engines and alternators.

Engine

- INTER Heavy duty diesel engine
- Water cooled
- Tropical type radiator

Alternator

- VDE 0530 & IEC 34-1 standardizations
- Synchron type brushless
- Automatic voltage regulation (AVR)
- Overload acceptance: 110% for 1 hour, 150% for 2 minutes
- Short circuit resistance: 300 for 10 seconds
- Insulation class: H
- Insulation resistance: 1800 VAC
- Voltage: 230/400 V three phase
- Voltage regulation: $\pm 0,5\%$
- Protection class: IP23
- Power factor (cosa) : 0,8
- Frequency: 50 Hz

Manuel Control Panel

- Microprocessed Electronic Control Panel
- Relays
- Protection fuses
- Thermic magnetic circuit breaker (TMS) 3-pole
- Emergency stop button

Automatic Control Panel

- Microprocessed AMF Electronic Control Panel
- Protection fuses
- Battery charger
- Power Transfer (For ATS)
- Emergency stop button

ENGINE

Number of Cylinder	3
Cylinder Arrangement	Vertical In-Line
Combustion System	Naturally
Fuel Consumption	Direct Injection
Compression Ratio	22.5:1
Cylinder Bore/Stroke	80 x 90
Displacement	
Cooling System	Water Cooled
Governor Type	Mechanic Governor
Electric System	12 VDC

Chassis

- Mounted on the steel base chassis
- Elastic vibration dampers between engine and chassis
- Chassis integrated fuel tank
- Dial type mechanical fuel indicator

Canopy

- Easy lifting and moving
- Metal parts are coated with electrostatic polyester coated, powder painted
- Thermally insulated exhaust system
- Acoustic insulation with rot* proof, moisture-repellent and non-flammable material (per DIN 4102 A2)

Please dont hesitate to contact with us to get a quotation according to your required engine and alternator.



DISCOVERY

EVERYTHING FOR INDUSTRY & SERVICES



Low & Medium Voltage Switchgear Equipments

Primary & Secondary Switchgear Equipments

Circuit Breakers

M.V. SF6 Gas Insulated Circuit Breaker

SF6 switchgear is thus capable of meeting the most demanding requirements of public and industrial distribution networks worldwide, up to 40.5 kV. The mechanical and electrical endurance of Our SF6 switchgear is far above that recommended by the IEC. This equipment meets the needs of power networks, even those operating under the most severe conditions.

The electrical contacts, housed in a sealed-for-life enclosure, require no special maintenance. The operating mechanism requires only minimum maintenance at intervals depending on the conditions of use. Under normal operating conditions, no preventive maintenance is required before 10 000 operations or 10 years of service.

The seal and the for-life lubrication of the rotary seals is provided by an oil film. In the MV circuit breaker field, for example, on more than 20 000 SF6 switchgear units installed by the European Electrical utility (EDF), the annual fault rate related to seal problems is less than 0.05 %.



M.V. Vacuum Interrupter Type Circuit Breaker

- Rated voltages 12 to 36 kV
- Maintenance-free up to 10,000 operating cycles
- Mechanical breaker service life 10,000 operating cycles
- Rated short-circuit breaking currents up to 31.5 kA (r.m.s.value), minimum 25 operating cycles
- DC component 36%, higher values on request
- Values of transient recovery voltage acc. to IEC 62 271-100, other values on request
- Upright installation
- User configurable secondary equipment
- Optimum replacement for breakers of conventional design, e.g. low-oil breakers and dead-tank oil circuit-breakers



- Suitable for use in conjunction with, for example:
 - Overhead lines and cables
 - Transformers
 - Capacitors
 - Filter circuits
 - Motors



Earthing Switches

Indoor earthing switches are used for ensure absolute de-energisation of medium-voltage equipment in a circuit or switchgear. Our Indoor Earthing Switches offer free-standing, robust and reliable solutions for medium – voltage earthing systems. With variations designed to serve for a wide range of system voltages, Güral Indoor Earthing Switches currently operate worldwide at system voltages from 12kV to 36kV. The flexibility of the design of our Indoor Earthing Switches allows almost any custom solutions requested by the client, insulation levels, driving variations and construction assembly types. The earthing switches can be equipped with insulators in accordance with IEC, ANSI or DIN specifications.

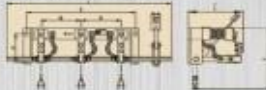

PROTECTION RELAYS

Fast, accurate monitoring and control of distribution assets maximizing grid efficiency and reliability. New site management tools allow you to properly maintain and manage your entire fleet of devices with real-time diagnostic data and site reports. The Motors, The Transformers, Feeder and Line Protection Systems offer advanced protection and communications with multi-protocol support. Discovery Foreign Trade is able to supply well-known brands high quality European, U.S. & Canada, Japan & Turkish Protection Relays.





Low & Medium Voltage Switchgear Equipments Primary & Secondary Switchgear Equipments

Signal Lamps, Push Buttons, Terminals, Bus-bars, Insulation Material, Contactor, MCB - MCCB

Our company able to supply appropriate product of well known international brands and Turkish brands from stock and also able to manufacture according to special requirements

Magnetothermic residual current devices with overcurrent protection RCBs combine in a single device the residual current function and the overcurrent protection function typical of MCBs.

RCBOs are tripped by both current leakage to earth and overloads and short-circuits and they are self-protecting up to a maximum short-circuit current value indicated on the label.

Molded Case Circuit Breaker/MCCB

1. comply with standard of IEC
 2. accord with standard of GB and so on
- Molded case circuit breaker is one new type breakers which this company adopts international advanced design, manufacture technology to develop, the rated insulating voltage is 750V, suitable for AC 50Hz(60Hz), rated working voltage 690V or below, rated working current is 12.5 to 1250A of circuit and use in distributing electric energy. on frequent making and breaking in the normal conditions and protecting when circuit and installation are overload, short circuit and under voltage. Rated shell-rack and the breaker which current is under 400A, take protect effect when mouse cage motor is non frequent start, breaking off working and protecting overload, short circuit and under voltage.



Discovery is the leading provider of solutions for the transmission of power, data and control signals in industrial environments. The company develops, produces and sells industrial electronics, network infrastructure components and connectivity solutions such as Industrial Ethernet, Relays, Power Supplies, I/O modules, printed circuit board connectors, terminal blocks and complete DIN Rail assemblies. The Weidmuller group has a strong international focus with manufacturing and sales locations in over 70 countries.

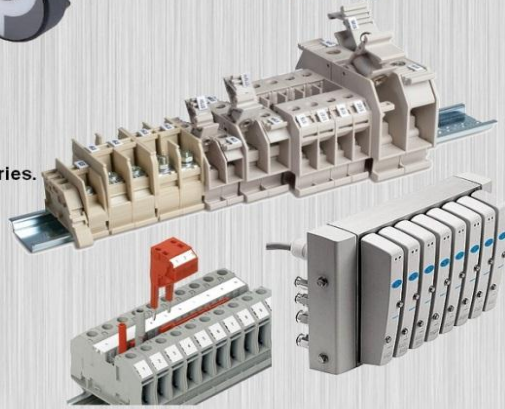



NEUTRAL GROUNDING RESISTORS

COMMON REASONS for USING NEUTRAL GROUNDING RESISTORS

- Reducing single phase fault currents which occur in M.V. electrical networks to prevent damages on transformers and generators,
- Reducing temporary over voltages occurred by braking instantaneous fault current,
- Providing long-life for switchgear,
- Reducing step voltages to a harmless level for staff.

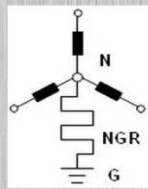

FEATURES

- Stainless-steel resistor elements.
- Current transformer included (EN 60044-1).
- Bolted resistor element connections instead of welded connections in order to be able to assemble spare parts on site immediately.
- Typically, RAL 7032 (and others) epoxy-based (70 micrometer thickness) polyester electrostatic powder paint for galvanized enclosure element to provide maximum resistance against corrosion.
- Typically, 2 mm hot dip galvanized steel enclosure.
- High thermal capacity to absorb high currents.
- High altitude ratings.
- Custom made lifting eyes provide secure lifting.
- Rugged shock-resistant construction

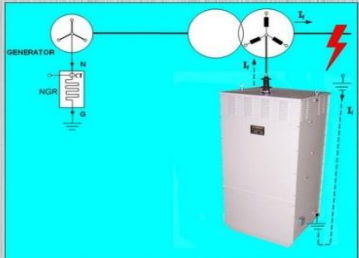

TECHNICAL SPECIFICATIONS

OPERATION VOLTAGE	Up to 72 kV line to line systems
RATED CURRENT (A)	Up to 5000
AMBIENT TEMPERATURE (°C)	< 55
RESISTANCE ALLOY	Stainless - steel
PROTECTION DEGREE	IP 23 (outdoor) and others
STANDARDS	IEEE 32, EN 60137, EN 60529, EN ISO 1461, EN 60288, EN 60273, EN 80071, EN 80080

Neutral Grounding Resistors are used for resistance grounding of industrial power system. They are generally connected between ground and neutral of transformers, generators and grounding transformers. Neutral Grounding Resistors are used in order to limit maximum fault current to a value which will not damage the equipment in the power system, yet allow sufficient flow of fault current to operate protective relays to clear the fault. Although it is possible to limit fault currents with high resistance Neutral Grounding Resistors, earth short circuit currents can be extremely reduced. As a result of this fact, protection devices may not sense the fault. Therefore, it is the most common application to limit single phase fault currents with low resistance Neutral Grounding Resistors to approximately rated current of transformer and / or generator.



Example : A 10000 kVA 13,8 kV generator's rated current is 419 A . Therefore, 400 A or 500 A Neutral Grounding Resistor is generally considered as suitable for that application.

Our resistors are designed to absorb a large amount of energy without exceeding temperature limitations defined in IEEE 32. Neutral Grounding Resistors our manufacture can be used for indoor and outdoor and the neutral point is connected with a porcelain bushing or with a (minimum cross-section = 70 mm² copper or 95 mm² aluminum) high voltage (XLPE) cable from the bottom. The most common protection degree preferred for Neutral Grounding Resistors is IP 23 as it allows the resistor elements to cool easier and they can be used both at sea shores and deserts because the resistor elements are completely stainless steel and does not get affected by extreme conditions. Neutral Grounding Resistors are sent with MAINTENANCE AND INSTALLATION GUIDELINES. In MAINTENANCE AND INSTALLATION GUIDELINES, recommended relay settings for each Neutral Grounding Resistor are stated as well. We provide complete technical assistance in order to meet your specifications or site conditions

ENCLOSURE FEATURES

- 2 mm hot dip galvanized steel enclosure.
- Epoxy-based RAL 7032 (or RAL 70XX) polyester electrostatic powder paint provides maximum protection.
- Solid top cover sloped to prevent water accumulation.
- Custom made lifting eye bolts for secure lifting.
- Front cover for easy access to connection and inspection.
- Corrosion resistant nameplate





EARTHING RESISTORS

OPTIONS

- Elevated support stands are provided for ground clearance and safety.
- Custom made AISI 304 stainless steel enclosures are available.
- Different paint types are available.
- Specially designed units for hazardous and extreme locations.
- Voltage transformers are mounted inside the resistor enclosure.
- Protection Relays are available.
- Porcelain entrance bushings can be mounted on top or on the side of Neutral Grounding Resistors.
- Motorized or manual single pole disconnector switches, voltage transformers, surge arresters and heaters in the Neutral Grounding Resistors



ROUTINE TESTS

- Measurement of insulation resistance between enclosure and resistor.
- Withstand test of dielectric strength at network frequency for one minute.
- Measurement of total DC resistance.
- Insulation test of resistor blocks.
- Galvanize thickness test.
- Paint thickness test.

TYPE TESTS (on demand)

- Temperature rise test
- Protection degree test
- Impulse voltage test (1,2 / 50 μ s)
- Measurement of AC resistance
- Seismic test



SELECTION DETAILS

- System Voltage
- Line to Neutral Voltage
- Desired Current Rating
- Desired Resistance Level
- Maximum Time ON (seconds)
- Bushing Entry or Cable Entry
- Current Transformer Ratio (if applicable)
- Disconnector Switch (if applicable)
- Special Options (if applicable)

DIMENSIONS OF SOME NEUTRAL GROUNDING RESISTORS				
U_n (kV)	I_n (A)	Second	Weight (kg)	W x L x H (cm)
36 / $\sqrt{3}$	1000	5	950	111 x 190 x (210 + 40*)
7.2 / $\sqrt{3}$	300	60	470	111 x 95 x 160
17.5 / $\sqrt{3}$	400	10	440	111 x 95 x 160
4.1 / $\sqrt{3}$	400	10	150	111 x 95 x 70
12 / $\sqrt{3}$	1000	5	400	111 x 95 x 160
11 / $\sqrt{3}$	700	10	380	111 x 95 x 210
6.9 / $\sqrt{3}$	400	10	280	111 x 95 x 160

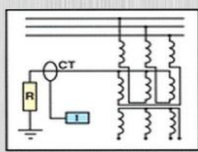
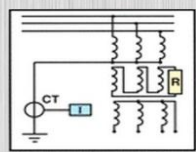
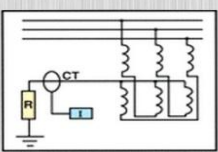

Examples of providing artificial neutral point if it is impossible to reach the neutral point of the source or the connection is delta.

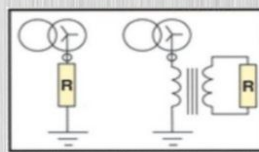

Examples of grounding the neutral point through the resistance



3D design of Neutral Grounding Resistors



DISCOVERY

EVERYTHING FOR INDUSTRY & SERVICES



TECHNICAL SPECIFICATIONS:

Operating Temperature Range: -25/D (-25 / +55 °C)

Capacitance Tolerance: -5 +10 %

Working Voltages (Un): 400 V (others as shown table 3)

Working Frequency: 50 Hz (upon request 60Hz)

Internal connection: Delta

Permitted Over Voltages: As shown tables 2

Permitted Over Current: 1,3 In

Inrush current: >100 In

Terminals: on terminal board, cable connectable terminals

Terminals Torque: 3 N.m

Dielectric Losses (Tan δ -dissipation fact.): <0.2 W/kVAR

Total Losses (Tan δ -dissipation fact.): <0.5 W/kVAR

Safety device: Internal over-pressure disconnecter.

Protection Class: IP20

Test Voltage Between Terminals: 2,15 Un AC, 2 sec

Test Voltage Between Terminals and Case: 3 KV AC, 10 sec

Fixing stud: M12 (max.torque 10 Nm)

Altitude: 2000 m. a.s.l.

Discharge Resistor: External . 75 V after 180 sec.

Reference Standards: Capacitors meet or exceed of IEC publication 60831-1/2; TS EN 60831-1 Quality Assurance Standards: TS EN ISO 9001- 2008,

Our quality system is described in Quality Manual



LONG LIFE:

Our ZnPS Capacitors are described as "self healing".

This means that they are capable of restoring.

After occurring short circuit between the electrodes,

the metal layers around the short circuit are vaporized and

short circuit is terminated. Due to the that fact; Our CAPACITORS are long lasting.

DESCRIPTION OF THE ZnPS TYPE CAPACITORS:

The dielectric is low loss polypropylene film and the electrodes are consist of a very thin metal coating on one side of the PP film layer coated under vacuum conditions. Two layer of metallized PP are wound into cylindrical windings. The windings are named as the Capacitor Elements. After metal spray application of both sides of the windings, the wire connections are provided. Those single phase capacitor elements are dehydrated under high vacuum conditions, impregnated with highly purified gas. The Capacitor Elements are encapsulated in polyurethane resin which is non toxic, environment compatible and having a high class insulation and mounted in aluminum tube. They are internally connected in delta position to give the required three phase output.

CONSTRUCTIONS:

ZnPS Capacitors are consist of self - healing metallized polypropylene film, plastic core, polyurethane resin, insulation materials, mechanical fuses (disconnecter), aluminium can and terminal block. All capacitors are equipped with discharge resistor on touch proof terminals and protection degree is IP20

APPLICATIONS:

ZnPS type capacitors have been designed for easy and quick assembly in banks. These are modular capacitors are used in automatic or manual power factor correction panels for low voltage applications.

PRODUCTION RANGE:

Other than products for different values of voltage, frequency, capacity and temperature those stated in the table 1 are also included in our production line.

NON POLLUTING:

All the materials used on Our CAPACITORS are non-toxic and completely environmentally compatible.

DIMENSIONS:

ZnPS Capacitors have standard dimensions. You can find dimensions and other details in the tables 5-10





CABLE CATALOG



Cabelte is one of the major European industrial groups dedicated to the manufacture of power and telecommunication cables.

The company has many decades of experience (founded in 1938) and know-how. Since the entrance of Atlanticables, Cabelte has gained even greater size and international reputation, driving forward the homologations and international achievement.

The wide range of products in the energy and telecommunications sectors comprises electrical cables for low, medium and high voltage (copper and aluminum), copper and optical fiber telecommunication cables, special purposes cables and cables for automotive industry.

Employing several hundred workers, especially in the industrial units of Portugal and Spain, as well as in all delegations that had been have created throughout the world, from Panama, France, Malta, Netherlands, Angola, Algeria and Mozambique, counting also with several international partners whether in Japan, China and Scandinavia, Cabelte has as ethics Values a strong concern for social aspects of the individual and ecological perspective.

Based on a strategy of "cost leader" search, through the constant development of new products and processes, to provide customers with high quality products and a strong level of competitiveness.

The strengthening of its skills through the integration of new products and services enable to create solutions tailored to each customer needs and develop systems for the telecommunication, energy and power transport and distribution grids, covering the scope of planning, installation, supervision and testing.

This catalog presents the main products manufactured in Cabelte production units and illustrates the ability and experience to supply the leading companies in the energy and telecommunications sectors, whether customers are utilities, transmission and distribution companies, operators or installers, operating around the world.





RESEARCH AND DEVELOPMENT

The group has an Engineering, Research and Development Center, which brings together a broad team of specialists in different areas, able to develop innovative solutions of cable and system design, allowing to meet the increased market demand in what concerns the installation efficiency, optimization of resources, security and environment.

PRODUCTION

Production facilities are organized following a production verticalization perspective, are equipped with modern and flexible equipment that permits to manufacture a wide range of products that guarantee the development and respect for the most demanding quality standards.

The industrial activities of Cabelte are strengthened with a set of modern management tools which final goal is to obtain "zero defects" level and to provide safe and reliable products, with the value added services tailored to each customer needs.





QUALITY

Quality Management is guaranteed in all phases of design and production, from raw materials to end product, including, when applicable, the analysis of the contract and post-sale, integrated on a broad vision of Total Quality Management, fully covering the different processes and companies areas.

Manufacturing plants are equipped with fixed and movable laboratories which, along with the high skilled and experienced workers, allow us to perform the necessary tests for complete characterization of our products. The traceability of supplied products is guaranteed through a computerized system.



CERTIFICATIONS

Depending on the specificity of our products and customers, our companies are certified under ISO 9001, ISO 14001, ISO/TS 16949. Furthermore, we also have quality agreements, and other specific qualifications for institutional customers, such as the large multinational operators in telecommunication and energy areas. We also comply with individual approvals for products and product ranges from government agencies in several countries as per established by various national, European and international standards.





INDEX

This catalog was prepared with the aim to show the main characteristics of Group Cabelte product range, trying to be as general as possible. In that sense there is a focus on IEC standards, although Group Cabelte has the ability to develop and produce many other cables designs covering very different cable specifications.

The portfolio presents in this catalogue is organized in power cables; low, medium and high voltage, bare aerial cables, telecommunications copper and fibre cables.

LOW VOLTAGE CABLES

BUILDING WIRE

- Single core non-sheathed

- 19 H05V-U • H05V-K
- 21 H07V-U • H07V-R • H07V-K
 - Single core non-sheathed, Fire retardant, Halogen free
- 23 H07Z1-K
 - Single and multicore sheathed
- 25 H05VV-F • 05VV-F

UTILITY AND INDUSTRIAL CABLES

Unarmoured

- Standard
- 27 Cu or Al / XLPE / PVC
 - Fire retardant, Halogen free
- 31 Cu or Al / XLPE / LSHF
 - Fire resistance, Halogen free
- 35 Cu / MICA / XLPE / LSHF
- 39 Cu / SI / LSHF
 - Control unscreened
- 41 Cu / PVC / PVC
- 43 Cu / XLPE / PVC
 - Screened
- 45 Cu / XLPE / Cu / PVC or LSHF
 - Concentric conductor
- 49 Cu / XLPE / Cu / PVC
- 51 Al / PVC / Cu / PVC
- 53 CNE • SNE
- 57 Branchement
- Armoured
 - Standard
- 59 Cu or Al / XLPE / STA or SWA / PVC
 - Fire retardant, Halogen free
- 63 Cu or Al / XLPE / STA or SWA / LSHF
- Overhead Aerial cables
- 67 Cu or Al / XLPE

71 MEDIUM VOLTAGE CABLES

SINGLE CORE CABLE

Unarmoured, Cross-linked Polyethylene Insulation – XLPE

- Standard IEC 60502-2
 - 73 Cu or Al / XLPE / Cu / PVC or PE
 - Flame retardant, Halogen free
 - 79 Cu or Al / XLPE / Cu / PO
 - Fire retardant, Halogen free
 - 81 Cu or Al / XLPE / Cu / PO
 - Standard BS 7870-4.10
 - 85 Al / XLPE / Cu / PE
 - Aluminium screen
 - 87 Cu or Al / XLPE / Al / PE
 - Reinforced transversal watertightness
 - 89 Cu or Al / XLPE / Cu / Al / PE
 - Standard IEC 60502-2
- Unarmoured, Ethylene Propylene Rubber Insulation – EPR
- 91 Cu or Al / EPR / Cu / PVC or PE
- Armoured, Cross-linked Polyethylene Insulation – XLPE
- Standard IEC 60502-2
 - 97 Cu or Al / XLPE / Cu / ATA or AWA / PVC or PE

THREE CORE CABLE

Unarmoured, Cross-linked Polyethylene Insulation – XLPE

- Standard IEC 60502-2
 - 103 Cu or Al / XLPE / Cu / PVC or PE
 - Standard BS 7870-4.20
 - 109 Al / XLPE / Cu / PE
 - Standard IEC 60502-2
- Armoured, Cross-linked Polyethylene Insulation – XLPE
- Standard IEC 60502-2
 - 111 Cu or Al / XLPE / Cu / STA or SWA / PVC or PE

THREE CORE BUNDLE CABLE

Cross-linked Polyethylene Insulation – XLPE

- Without messenger
- 117 Cu or Al / XLPE / Cu / PVC or PE
 - With messenger
- 119 Al / XLPE / Cu / PVC or PE

121 HIGH VOLTAGE CABLES

- 121 • XHIOLE (cbe) • LXHIOLE (cbe)

123 BARE CONDUCTORS FOR AERIAL POWER LINES

- 125 • AAC – All aluminium conductor
- 131 • AAAC – All aluminium alloy conductor
- 137 • ACSR – Aluminium conductor steel reinforced
- 147 • AACSR – Aluminium alloy conductor steel reinforced
- 151 • ACSR/AW – Aluminium alloy conductor Aluminium clad steel reinforced
- 155 • ACAR – Aluminium conductor Aluminium alloy reinforced

OPTICAL POWER GROUND WIRE

- 159 • OPGW – stainless steel tube
- 161 • OPGW – aluminium tube

163 TELECOM COPPER CABLES

SUBSCRIBER NETWORK

DROP CABLE

- PE insulation, Aerial installation

165 TE1SE

INDOOR CABLES

- PVC insulation, PVC sheath

167 TVHV • TVV

- PE insulation, PVC or LSHF sheath

169 TEV • TEZ1

- PVC insulation, Al screen, PVC sheath

171 SYT1 0,6/0,9

LOCAL NETWORK

PAIR CABLES

- PE insulation, Al screen, PE or LSHF sheath

173 TE1HE • TE1HZ1 • TE1HE2AE • TE1HES

- PE insulation, Jelly filled

179 T1EG1HE • T1EG1HEAE

QUAD CABLES

- PE insulation, Al screen, PE sheath

181 TE1HE • TE1HEAV • TE1HEAE

- Smart grid, PVC insulation, Al screen, PVC sheath

183 Téléreport Armé • Téléreport Non Armé

185 RAILWAY SIGNALING CABLES

PAIR CABLES

- PE insulation / Al screen / Corrugated armour / Dry core

187 TE1HE2AE • TE1HZ12AZ1 • TE1HE2AES

- PE insulation / Al screen / Corrugated armour / Jelly filled

191 TEG1HE2AE

QUAD CABLES

- PE insulation / Al screen / Corrugated armour / Dry core

193 TE1HE2AE • TE1HZ12AZ1 • TE1HE2AES

- PE insulation / Al screen / Corrugated armour / Jelly filled

197 TEG1HE2AE

CABLES WITH REDUCTION FACTOR

PAIR CABLES

- PE insulation / Copper screen + armour / PVC

199 ZPAU

- PE insulation / Copper or Al screen + armour / PE or LSHF

201 TEOEAE • TEOZ1AZ1 • TE1REAE • TE1RZ1AZ1 • TE3HEAE • TE3HZ1AZ1

- PE insulation / Copper or Al screen / armour / PE / Jelly filled

205 TEGOEAE • TEG1REAE

QUAD CABLES

- PE insulation / Copper or Al screen + armour / PE OR LSHF
- 207 TEOEAE • TEOZ1AZ1 • TE1REAE • TE1RZ1AZ1 • TE3HEAE • TE3HZ1AZ1
- PE insulation / Copper or Al screen + armour / PE / Jelly filled
- 211 TEGOEAE • TEG1REAE

213 CONTROL & INSTRUMENTATION CABLES

MULTICORE, OVERALL SCREEN

UNARMoured

- Cu / PVC, PE or XLPE / Al or Copper screen / PVC or LSHF
- 215 VHV • FVHV • EHV • FEHV • XHV • FXHV • XHZ1 • FXHZ1
- Cu / LSHF / Al screen / LSHF

- 217 Z1HZ1

ARMoured

- Cu / PE / Al screen / PE or LSHF / Corrugated Armour / PE or LSHF
- 219 E1HE2AE • E1HZ12AZ1

PAIRS, OVERALL SCREEN

UNARMoured

- Cu / PE, PVC or XLPE / Al screen / PVC or LSHF
- 221 EHV • FEHV • VHV • FVHV • XHV • FXHV • XHZ1 • FXHZ1

ARMoured

- Cu / PVC, PE or XLPE / Al Screen / PVC / STA or SWA / PVC or LSHF
- 223 VHV RV • FVHV RV • VHV AV • FVHV AV • EHV RV • FEHV RV • EHV AV • FEHV AV • XHV RV • FXHV RV • XHV AV • FXHV AV
- XHZ1RZ1 • FXHZ1RZ1 • XHZ1AZ1 • FXHZ1AZ1

PAIRS, SCREENED PAIR

UNARMoured

- Cu / PVC or PE or XLPE / Individual Al Screen / Colective Al Screen / PVC or LSHF
- 225 VHIV • FVHIV • VHIV • FVHIV • EHIV • FEHIV • EHIV • FEHIV • XHIV • FXHIV • XHIV • FXHIV
- XHIZ1 • FXHIZ1 • XHIZ1 • FXHIZ1

ARMoured

- Cu / PVC or PE or XLPE / Individual Al Screen / Colective Al Screen / PVC or LSHF / STA or SWA / PVC or LSHF
- 227 VHIV RV • FVHIV RV • VHIV AV • FVHIV AV • EHIV RV • FEHIV RV • EHIV AV • FEHIV AV • XHIV RV • FXHIV RV
- XHIV AV • FXHIV AV • XHIZ1RZ1 • FXHIZ1RZ1 • XHIZ1AZ1 • FXHIZ1AZ1

229 OPTICAL FIBRE CABLES

UNARMoured

- 231 • Unitube – TOU ZvE
- 233 • Unitube flame retardant – TOU ZvZ1
- 235 • Unitube anti-rodent – TOU ZrE
- 237 • Unitube anti-rodent, flame retardant – TOU ZrZ1
- 239 • Multitube – TON ZvE
- 241 • Multitube flame retardant – TON ZvZ1
- 243 • Multitube anti-rodent – TON ZrE
- 245 • Multitube anti-rodent, flame retardant – TON ZrZ1
- 247 • Multitube double jacket – TON EZaE • PKP
- 249 • Multitube double jacket, fire retardant – TON Z1ZaZ1 • TKT

ARMOURED

- 251 • Unitube – TOU ZvE2AE
- 253 • Unitube fire retardant – TOU ZvZ12AZ1
- 255 • Multitube – TON ZvE2AE
- 257 • Multitube fire retardant – TON ZvZ12AZ1
- 259 • Multitube – TON Zv2AE
- 261 • Multitube double jacket, jelly filled – PESP-DR • Fire retardant TEST-DR
- 263 • Multitube double jacket, jelly filled, tensile reinforced – PKESP-DR • Fire retardant TEST-DR

AERIAL

- 265 • TON ES – 8 figure short span
- 267 • ADSS – short span
- 269 • ADSS – medium span

271 OPTICAL FIBRE

SINGLE-MODE

- 273 • Zero dispersion shifted fibre ITU-T G.652B
- 275 • Zero dispersion shifted fibre ITU-T G.652D
- 277 • Non-zero dispersion shifted fibre ITU-T G.655

MULTIMODE

- 278 • 50/125 OM1
- 279 • 50/125 OM2
- 280 • 50/125 OM3
- 281 • 62,5/125 OM1
- 282 • 62,5/125 OM2

283 SERVICE AND ACCESSORIES

- 285 "Turn-Key" Solutions
- 287 Services
- 287 Portfolio
- 287 Accessories for Cables

LOW VOLTAGE CABLES

BUILDING WIRE

- Single core non-sheathed
H05V-U · H05V-K
H07V-U · H07V-R · H07V-K
- Single core non-sheathed, Fire retardant, Halogen free
H07Z1-K
- Single and multicore sheathed
H05VV-F · 05VV-F

UTILITY AND INDUSTRIAL CABLES

Unarmoured

- Standard
CU or AL / XLPE / PVC
 - Fire retardant, Halogen free
CU or AL / XLPE / LSHF
 - Fire resistance, Halogen free
CU / MICA / XLPE / LSHF
CU / SI / LSHF
 - Control unscreened
CU / PVC / PVC
CU / XLPE / PVC
 - Screened
CU / XLPE / CU / PVC or LSHF
 - Concentric conductor
CU / XLPE / CU / PVC
CNE · SNE
- Branchement

Armoured

- Standard
CU or AL / XLPE / STA or SWA / PVC
- Fire retardant, Halogen free
CU or AL / XLPE / STA or SWA / LSHF

Overhead Aerial cables

CU or AL / XLPE

LOW VOLTAGE CABLE

APPLICATION

Single core insulated conductor, without sheath, for general purposes, and rated voltages up to 300/500 V. Suitable for installation in surface mounted or embedded conduits, only for signalling or control circuits. Recommended fixed protected installation inside appliances and in, or on, lighting fittings.

CABLE DESIGNATION

Cu / PVC: H05V-U • H05V-K

CONSTRUCTION CHARACTERISTICS

Conductor

Copper (plain annealed): Solid class 1: (H05V-U)
Flexible class 5: (H05V-K)

Insulation

PVC – (Polyvinyl chloride), type TI 1.

COLOUR AND CABLE MARKING

Black • Blue • Brown • Grey • Orange • Pink • Red • Turquoise • Violet • White • Green • Yellow.

Bi-colours of any combination of the above mono-colours are permitted.

Oversheath marked at regular intervals with the following information:

<CERTIF> <HAR> CABELTE H05V-U (K)

GENERAL CHARACTERISTICS

Construction and test standards	IEC 60228 HD 21.3
Rated voltage U_0/U	300/500 V
Test voltage	2 000 V a.c. 5 minutes
Conductor maximum operating temperature	70°C
Maximum short-circuit temperature	160°C ($t \leq 5s$)
Minimum bending radius (mm)	H05V-U 4xd H05V-K 3xd
Maximum pulling force over conductor (N)	H05V-U 50 x S H05V-K 15 x S
Flame retardant	IEC 60332-1-2 • EN 60332-1-2 (cable vertically mounted, length of charred cable ≤ 540 mm).

S – conductor cross-section (mm²)

d – cable outer diameter (mm)

ELECTRICAL AND DIMENSIONAL CHARACTERISTICS

Cable composition n.° cond. x cross-section (mm ²)	Approximate outer diameter (mm)	Approximate weight (kg/km)	Current carrying capacity in open air T = 30° C 2 or 3 charged conductors (A)
H05V-U			
1 x 0,5	2,1	10	3
1 x 0,75	2,3	13	6
1x1	2,4	15	10
H05V-K			
1 x 0,5	2,2	10	3
1 x 0,75	2,5	13	6
1x1	2,6	15	10

LOW VOLTAGE CABLE

APPLICATION

Single core insulated conductor, without sheath, for general purposes. Suitable for fixed protected installation in, or on, lightning or controlgear for rated voltages up to 450/750 V. Installation in surface mounted or embedded conduits, or similar closed systems.

Extra sliding cable.

CABLE DESIGNATION

Cu / PVC: H07V-U • H07V-R • H07V-K

CONSTRUCTION CHARACTERISTICS

Conductor

Copper (plain annealed): Solid class 1: (H07V-U)
Rigid stranded class 2: (H07V-R)
Flexible class 5: (H07V-K)

Insulation

PVC (Polyvinyl chloride), type TI 1.

COLOUR AND CABLE MARKING

Black • Blue • Brown • Grey • Orange • Pink • Red • Turquoise • Violet • White.

Bi-colours not used except the combination of the mono-colours green and yellow.

Oversheath marked at regular intervals with the following information:

<CERTIF> <HAR> CABELTE H07V-U (R) (K)

GENERAL CHARACTERISTICS

Construction and test standards	IEC 60228 HD 21.3
Rated voltage U_0/U	450/750 V
Test voltage	2 500 V a.c. 5 minutes
Conductor maximum operating temperature	70°C
Maximum short-circuit temperature	160°C (t ≤ 5s)
Minimum bending radius (mm)	H07V-U (R) 4 x d if d ≤ 8 • 5 x d if 8 < d ≤ 12 • 6 x d if d > 12 H07V-K 3 x d if d ≤ 12 • 4 x d if d > 12
Maximum pulling force over conductor (N)	H07V-U (R) 50 x S H07V-K 15 x S recomend not exceed 1000 N
Flame retardant	IEC 60332-1-2 • EN 60332-1-2 (cable vertically mounted, length of charred cable ≤ 540 mm)

S – conductor cross-section (mm²)

d – cable outer diameter (mm)



ELECTRICAL AND DIMENSIONAL CHARACTERISTICS

Cable composition n.º cond. x cross-section (mm²)	Approximate outer diameter (mm)	Approximate weight (kg/km)	Current carrying capacity One circuit inside embedded conduits T = 30°C (A)	
			2 charged conductors	3 charged conductors
H07V-U				
1 x 1,5	3,0	20	17,5	15,5
1 x 2,5	3,5	30	24	21
1x4	4,0	45	32	28
1x6	4,5	65	41	36
H07V-R				
1 x 1,5	3,5	20	17,5	15,5
1 x 2,5	4,0	35	24	21
1x4	4,5	50	32	28
1x6	5,0	70	41	36
1 x 10	6,5	110	57	50
1 x 16	7,5	180	76	68
1 x 25	9,0	265	101	89
1 x 35	10,0	350	125	110
1 x 50	11,5	490	151	134
1 x 70	13,5	695	192	171
1 x 95	15,5	960	232	207
1 x 120	17,0	1 200	269	239
1 x 150	19,0	1 450		
1 x 185	21,0	1 845		
1 x 240	24,0	2 405		
1 x 300	26,5	3 045		
1 x 400	30,0	3 845		
H07V-K				
1 x 1,5	3,0	20	17,5	15,5
1 x 2,5	3,7	35	24	21
1x4	4,2	50	32	28
1x6	5,5	70	41	36
1 x 10	6,5	110	57	50
1 x 16	8,5	175	76	68
1 x 25	9,5	255	101	89
1 x 35	11,0	350	125	110
1 x 50	13,5	515	151	134
1 x 70	15,0	675	192	171
1 x 95	16,5	890	232	207
1 x 120	18,5	1 145	269	239
1 x 150	20,5	1 420		
1 x 185	22,5	1 715		
1 x 240	29,0	2 310		

Other compositions are available, contact inform@cabelte.pt for information.
Only one circuit is considered.

APPLICATION

Single core, fire-proof, high security cable, insulated with thermoplastic halogen-free compound. Recommended for indoor use, fixed installations, in public areas such as hospitals, hotels, shopping malls, halls, computer and communication centres and, in general, in all places with large number of people and electrical/electronic equipment.

CABLE DESIGNATION

Cu / PVC: H07Z1-K

CONSTRUCTION CHARACTERISTICS

Conductor

Copper (plain annealed): Flexible class 5.

Insulation

LSHF – Low Smoke Halogen Free thermoplastic compound, fire retardant, type TI 7.

COLOUR AND CABLE MARKING

Black • Blue • Brown • Grey • Orange • Pink • Red • Turquoise • Violet • White.
Bi-colours not used except the combination of the mono-colours green and yellow.
Oversheath marked at regular intervals with the following information:
<CERTIF> <HAR> CABELTE H07Z1-K TYPE 2

GENERAL CHARACTERISTICS

Construction and test standards	IEC 60228 HD 21.15
Rated voltage U ₀ /U	450/750 V
Test voltage	2 500 V a.c. 5 minutes
Conductor maximum operating temperature	70°C
Maximum short-circuit temperature	160°C (t ≤ 5s)
Minimum bending radius (mm)	9xd
Maximum pulling force over conductor (N)	15 x S
Flame retardant	IEC 60332-1-2 • EN 60332-1-2 (cable vertically mounted, length of charred cable ≤ 540 mm)
Fire retardant	IEC 60332-3-24 • EN 60332-3-24 (bunch of cables vertically mounted on a ladder, length of charred cable ≤ 2,5 m)
Halogen free	
Low smoke	IEC 61034-2 • EN 61034-2 (cable light transmittance ≥ 60%)
Low toxicity	IEC 60754-1 • EN 50267-2-1 (halogen acid gas content ≤ 0,5%)
Low corrosivity	IEC 60754-2 • EN 50267-2-2 (pH ≥4,3 • conductivity ≤ 10µS/mm)

S – conductor cross-section (mm²)

d – cable outer diameter (mm)



We reserve the right to modify, at any time, without any obligation and without prior notice, the specifications and other technical data in this document, which must be confirmed when ordering.



ELECTRICAL AND DIMENSIONAL CHARACTERISTICS

Cable composition n.º cond. x cross-section (mm²)	Approximate outer diameter (mm)	Approximate weight (kg/km)	Current carrying capacity One circuit inside embedded conduits T = 30°C (A)	
			2 charged conductors	3 charged conductors
1 x 1,5	3,0	20	17,5	15,5
1 x 2,5	4,0	35	24	21
1x4	4,5	46	32	28
1x6	5,0	65	41	36
1 x 10	6,5	115	57	50
1 x 16	7,5	170	76	68
1 x 25	9,5	260	101	89
1 x 35	10,5	350	125	110
1 x 50	12,5	495	151	134
1 x 70	15,0	680	192	171
1 x 95	16,5	890	232	207
1 x 120	18,5	1 130	269	239

Other compositions are available, contact inform@cabelte.pt for information.

Only one circuit is considered.

LOW VOLTAGE CABLE

APPLICATION

Power supply cable for indoor installation, for rated voltages up to 300/500 V. Used in premises, kitchens, offices; for household appliances, including in damp premises, for medium duties like washing and drying machines, refrigerators and office machines.

CABLE DESIGNATION

Cu / PVC / PVC: H05VV-F • 05VV-F

CONSTRUCTION CHARACTERISTICS

Conductor

Copper (plain annealed): Flexible Class 5.

Insulation

PVC (Polyvinyl chloride), type TI 2.

Oversheath

PVC (Polyvinyl chloride), type TM 2.

COLOUR AND CABLE MARKING

Black (or other upon request).

Oversheath marked at regular intervals with the following information:

<CERTIF> <HAR> CABELTE H05VV-F

CABELTE 05VV-F

IDENTIFICATION OF INSULATED CONDUCTORS

N.º of conductors		2	3	4	5
Insulation colouring (HD 308.S2)	With earth conductor	-	GYNE-BU-BN	GYNE-BN-BK-GY	GYNE-BU-BN-BK-GY
	Without earth conductor	BU-BN	BN-BK-GY	BU-BN-BK-GY	BU-BN-BK-GY-BK

GENERAL CHARACTERISTICS

Construction and test standards	IEC 60228 HD 21.5
Rated voltage U ₀ /U	300/500 V
Test voltage	1 500 V a.c. 5 minutes (S = 0,75 and 1 mm ²)
	2 000 V a.c. 5 minutes (S ≥ 1,5 mm ²)
Conductor maximum operating temperature	70°C
Maximum short-circuit temperature	160°C (t ≤ 5s)
Minimum bending radius (mm)	5 x d if d ≤ 12 • 6 x d if d > 12
Maximum pulling force over conductor (N)	15 x S recomend not exceed 1000 N
Flame retardant	IEC 60332-1-2 • EN 60332-1-2 (cable vertically mounted, length of charred cable ≤ 540 mm)

S – conductor cross-section (mm²)

d – cable outer diameter (mm)



ELECTRICAL AND DIMENSIONAL CHARACTERISTICS

Cable composition n.º cond. x cross-section (mm ²)	Approximate outer diameter (mm)	Approximate weight (kg/km)	Current carrying capacity In open air T = 30°C (A)	
			2 charged conductors	3 charged conductors
H05VV-F				
2 x 0,75	7,0	55	6	
2 x 1,0	7,0	65	10	
2 x 1,5	8,0	85	22	
2 x 2,5	10,0	135	30	
2x4	11,0	185	40	
3 x 0,75	7,5	70	6	
3 x 1,0	7,5	80	10	
3 x 1,5	9,0	110	22	
3 x 2,5	10,5	170	30	
3x4	12,0	235	40	
4 x 0,75	8,0	80		12
4 x 1,0	8,5	100		13
4 x 1,5	10,0	140		18
4 x 2,5	11,5	205		25
4x4	13,0	290		34
5 x 0,75	9,0	105		6
5 x 1,0	9,5	130		10
5 x 1,5	11,0	165		18
5 x 2,5	13,0	250		25
5x4	14,5	375		34
05VV-F				
2x6	13,5	265	51	
3x6	14,0	335	51	
4x6	15,5	415		43
5x6	16,0	475		43
7 x 1,5	12,0	225	12	
7 x 2,5	14,5	340	16	

Other compositions are available, contact inform@cabelte.pt for information.

Only one circuit is considered.

Cables with 2 and 3 conductors: 2 charged conductors.

Cables with 4 and 5 conductors: 3 charged conductors.

LOW VOLTAGE CABLE

APPLICATION

Power supply cable for rated voltage up to 0,6/1kV. Suitable for indoor and outdoor fixed installations, protected or not, in industrial areas, buildings and similar applications.

CABLE DESIGNATION

Cu / XLPE / PVC: XV • FXV

Al / XLPE / PVC: LXV

F – Flexible

CONSTRUCTION CHARACTERISTICS

Conductor

Copper (plain annealed): solid class 1 or stranded class 2 or flexible class 5, circular or sector shaped
Aluminium: stranded class 2, circular or sector shaped.

Insulation

XLPE – (Cross-linked polyethylene).

Oversheath

PVC – (Polyvinyl chloride), type ST 2.

COLOUR AND CABLE MARKING

Black (or other upon agreement).

Oversheath marked at regular intervals with the following information:

CABELTE <Cable designation> <n.º cond.> x <cross-section> 0,6/1kV <year of manufacture> <metric marking>

IDENTIFICATION OF INSULATED CONDUCTORS

N.º of conductors		2	3	4	5
Insulation colouring (HD 308.S2)	With earth conductor	-	GYNE-BU-BN	GYNE-BN-BK-GY	GYNE-BU-BN-BK-GY
	Without earth conductor	BU-BN	BN-BK-GY	BU-BN-BK-GY	BU-BN-BK-GY-BK

GENERAL CHARACTERISTICS

Construction and test standards	IEC 60228 • IEC 60502-1
Rated voltage U ₀ /U	0,6 / 1 kV
Test voltage	3,5 kV a.c. 5 minutes
Conductor maximum operating temperature	90°C
Maximum short-circuit temperature	250°C (t ≤ 5s)
Minimum bending radius (mm) (permanent, after installation) (during installation)	4xd if d<25 • 6xd if d≥25 • 8xd if sector shape cond. 6xd if d<25 • 9xd if d≥25 • 12xd if sector shape cond.
Maximum pulling force over conductor (N)	Copper – 50 x S Aluminium – 30 x S
Flame retardant	IEC 60332-1-2 • EN 60332-1-2 (cable vertically mounted, length of charred cable ≤ 540 mm)

S – conductor cross-section (mm²)

d – cable outer diameter (mm)



We reserve the right to modify, at any time, without any obligation and without prior notice, the specifications and other technical data in this document, which must be confirmed when ordering.



ADDITIONAL CHARACTERISTICS *

Fire retardant (frt) IEC 60332-3-24 • EN 60332-3-24 (bunch of cables vertically mounted on a ladder, length of charred cable ≤ 2,5 m)

Oil resistant, Hidrocarbon resistance

*Can be supplied upon agreement.

ELECTRICAL AND DIMENSIONAL CHARACTERISTICS

Cable composition n.º cond. x cross-section (mm²)	Approximate outer diameter (mm)	Approximate weight (kg/km)	Current carrying capacity In open air (T = 30°C) (A)	
			2 charged conductors	3 charged conductors
XV				
1 x 10	8,5	150		75
1 x 16	9,5	210		100
1 x 25	11	310	161	127
1 x 35	12,5	405	200	158
1 x 50	13,5	530	242	192
1 x 70	15,5	735	310	246
1 x 95	17,5	985	377	298
1 x 120	19,5	1 230	437	346
1 x 150	21	1 490	504	399
1 x 185	22,5	1 855	575	456
1 x 240	25,5	2 395	679	538
1 x 300	29	3 020	783	621
1 x 400	32,5	3 940	940	
1 x 500	36	4 875	1 083	
2 x 1,5	9	115	26	
2 x 2,5	9,5	145	36	
2x4	11	190	49	
2x6	12	245	63	
2 x 10	14,5	380	86	
2 x 16	16,5	535	115	
2 x 25	20,5	835	149	
2 x 35 (1)	17,5	800	185	
2 x 50(1)	20	1 060	225	
3 x 1,5	9,5	130	26	
3 x 2,5	10	170	36	
3x4	11,5	230	49	
3x6	12,5	300	63	
3 x 10	15,5	470	86	

LOW VOLTAGE CABLE

Cable composition n.º cond. x cross-section (mm ²)	Approximate outer diameter (mm)	Approximate weight (kg/km)	Current carrying capacity In open air ²⁾ T = 30°C (A)	
			2 charged conductors	3 charged conductors
3 x 16	18	700	115	
3 x 25	22	1 050	149	
3 x 35 ⁽¹⁾	20,5	1 145	185	
3 x 50 ⁽¹⁾	23,5	1 520	225	
4 x 1,5	10	155		23
4 x 2,5	11	205		32
4x4	12,5	275		42
4x6	13,5	370		54
4 x 10	16,5	560		75
4 x 16	19,5	865		100
3 x 16 + 1 x 10	19	815		100
3 x 25 + 1 x 16	23	1 220		127
3 x 35 + 1 x 16 ⁽¹⁾	24	1 360		158
3 x 50 + 1 x 25 ⁽¹⁾	27	1 825		192
3 x 70 + 1 x 35 ⁽¹⁾	31,5	2 575		246
3 x 95 + 1 x 50 ⁽¹⁾	35,5	3 520		298
3 x 120 + 1 x 70 ⁽¹⁾	39	4 410		346
3 x 150 + 1 x 70 ⁽¹⁾	42,5	5 375		399
3 x 185 + 1 x 95 ⁽¹⁾	45	6 835		456
3 x 240 + 1 x 120 ⁽¹⁾	53	8 655		538
5 x 1,5	11	185		23
5 x 2,5	12	245		32
5x4	13,5	335		42
5x6	14,5	450		54
5 x 10	18	690		75
5 x 16	21,5	1 065		100
3 x 16 + 2G10	20	885		100
3 x 25 + 2G16	24,5	1 380		127
3 x 35 + 2G16	26	1 705		158
3 x 50 + 2G25	30,5	2 340		192
3 x 70 + 2G35	35	3 260		246
3 x 95 + 2G50	41	4 490		298
3 x 120 + 2G70	46	5 805		346
3 x 150 + 2G70	49	6 735		399
3 x 185 + 2G95	53,5	8 505		456
3 x 240 + 2G120	61	10 985		500



We reserve the right to modify, at any time, without any obligation and without prior notice, the specifications and other technical data in this document, which must be confirmed when ordering.



Cable composition n.º cond. x cross-section (mm ²)	Approximate outer diameter (mm)	Approximate weight (kg/km)	Current carrying capacity In open air(2) T = 30°C (A)	
			2 charged conductors	3 charged conductors
LXV				
1 x 16	9,5	115		77
1 x 25	11	155	121	97
1 x 35	12	195	150	120
1 x 50	13,5	240	184	146
1 x 70	15,5	320	237	187
1 x 95	17	410	289	227
1 x 120	19	505	337	263
1 x 150	21	605	389	304
1 x 185	23	745	447	347
1 x 240	25,5	925	530	407
1 x 300	29	1 145	613	471
1 x 400	32,5	1 465	740	
1 x 500	36	1 820	856	
1 x 630	41,5	2 375	996	
4 x 16	19,5	475		77
4 x 25	24	695		97
3 x 25 + 1 x 16	23	665		97
3 x 35 + 1 x 16 (1)	24	625		120
3 x 50 + 1 x 25 (1)	27	795		146
3 x 70 + 1 x 35 (1)	31,5	1 110		187
3 x 95 + 1 x 50 (1)	35,5	1 455		227
3 x 120 + 1 x 70 (1)	39	1 800		263
3 x 150 + 1 x 70 (1)	42,5	2 200		304
3 x 185 + 1 x 95 (1)	45	2 700		347
3 x 240 + 1 x 120 (1)	53	3 475		407

Other compositions are available, contact inform@cabelte.pt for information.

(1) Phase conductors sector shape.

(2) Installation in free air or on perforated cable tray, horizontal or vertical.

Only one circuit is considered.

Cables with 2 and 3 conductors: 2 charged conductors.

Cables with 4 and 5 conductors: 3 charged conductors.

For compositions of 4 conductors, the same characteristics apply if the fourth conductor is the earth conductor or neutral conductor.

LOW VOLTAGE CABLE

APPLICATION

Power supply in places requiring extra fire safety precautions. Fire retardant, high security cable, for rated voltages up to 0,6/1k. Suitable for fixed installations, in public areas such as hospitals, hotels, shopping malls, computer and communication centres and, in general, in all places where it is required a high degree of protection of persons and assets or/and with a large number of people and electrical and electronic equipment.

CABLE DESIGNATION

Cu/XLPE/LSHF: XZ1 (frt,zh) • FXZ1 (frt,zh)

Al/XLPE/LSHF: LXZ1(frt,zh)

F – Flexible

CONSTRUCTION CHARACTERISTICS

Conductor

Copper (plain annealed): solid class 1, or stranded class 2, or flexible class 5, circular or sector shape.
Aluminium: stranded class 2, circular or sector shape.

Insulation

XLPE – (Cross-linked polyethylene).

Oversheath

LSHF – Low Smoke Halogen Free thermoplastic compound, fire retardant, type ST8.

COLOUR AND CABLE MARKING

Green or Black upon request. Oversheath marked at regular intervals with the following information:

CABELTE <Cable designation> <n.º cond.> x <cross-section> 0,6/1kV <year of manufacture> <metric marking>

IDENTIFICATION OF INSULATED CONDUCTORS

N.º of conductors		2	3	4	5
Insulation colouring (HD 308.S2)	With earth conductor	-	GYE–BU–BN	GYE–BN–BK–GY	GYE–BU–BN–BK–GY
	Without earth conductor	BU–BN	BN–BK–GY	BU–BN–BK–GY	BU–BN–BK–GY–BK

Insulation colour for single core cables – Black.

GENERAL CHARACTERISTICS

Construction and test standards	IEC 60228 • IEC 60502-1
Rated voltage U ₀ /U	0,6 / 1 kV
Test voltage	3,5 kV a.c. 5 minutes
Conductor maximum operating temperature	90°C
Maximum short-circuit temperature	250°C (t ≤ 5s)
Minimum bending radius (mm) (permanent, after installation) (during installation)	4xd if d < 25 • 6xd if d ≥ 25 • 8xd if sector shape cond. 6xd if d < 25 • 9xd if d ≥ 25 • 12xd if sector shape cond.
Maximum pulling force over conductor (N)	Copper – 50 x S Aluminium – 30 x S

S – conductor cross-section (mm²) • d – cable outer diameter (mm)



Flame retardant	IEC 60332-1-2 • EN 60332-1-2 (cable vertically mounted, length of charred cable ≤ 540 mm)
Fire retardant (frt)	IEC 60332-3-24 • EN 60332-3-24 (bunch of cables vertically mounted on a ladder, length of charred cable ≤ 2,5 m)
Halogen free (zh)	
Low smoke	IEC 61034-2 • EN 61034-2 (cable light transmittance ≥ 60%)
Low toxicity	IEC 60754-1 • EN 50267-2-1 (halogen acid gas content ≤ 0,5%)
Low corrosivity	IEC 60754-2 • EN 50267-2-3 (pH ≥4,3 • conductivity ≤ 10μS/mm)

ELECTRICAL AND DIMENSIONAL CHARACTERISTICS

Cable composition n.° cond. x cross-section (mm ²)	Approximate outer diameter (mm)	Approximate weight (kg/km)	Current carrying capacity In open air(2) T = 30° C (A)	
			2 charged conductors	3 charged conductors
XZ1				
1 x 10	8,5	135		
1 x 16	9,5	195		
1 x 25	11,0	295	161	
1 x 35	12,0	385	200	
1 x 50	13,5	510	242	
1 x 70	15,5	715	310	
1 x 95	17,5	970	377	
1 x 120	19,5	1 215	437	
1 x 150	21,0	1 480	504	
1 x 185	22,5	1 840	575	
1 x 240	25,5	2 375	679	
1 x 300	29,5	2 980	783	
2 x 1,5	9,0	110	26	
2 x 2,5	9,5	135	36	
2x4	11,0	180	49	
2x6	12,0	235	63	
2 x 10	14,5	350	86	
2 x 16	16,5	500	115	
3 x 1,5	9,5	125	26	
3 x 2,5	10,0	160	36	
3x4	11,5	220	49	
3x6	12,5	290	63	
3 x 10	15,5	440	86	
3 x 16	18,0	635	115	
4 x 1,5	10,0	145		
4 x 2,5	11,0	195		23
4x4	12,5	265		32
4x6	13,5	355		42
4 x 10	16,5	550		54
3 x 16 + 1 x 10	18,5	745		75
3 x 25 + 1 x 16	23,0	1 140		100
3 x 35 + 1 x 16 (1)	24,0	1 330		127
				158

LOW VOLTAGE CABLE

Cable composition n.º cond. x cross-section (mm ²)	Approximate outer diameter (mm)	Approximate weight (kg/km)	Current carrying capacity In open air(2) T = 30° C (A)	
			2 charged conductors	3 charged conductors
3 x 50 + 1 x 25 (1)	27,0	1 795		192
3 x 70 + 1 x 35 (1)	31,5	2 535		246
3 x 95 + 1 x 50 (1)	35,5	3 460		298
3 x 120 + 1 x 70 (1)	39,0	4 385		346
3 x 150 + 1 x 70 (1)	42,5	5 295		399
3 x 185 + 1 x 95 (1)	45,0	6 735		456
3 x 240 + 1 x 120 (1)	53,0	8 550		538
5 x 1,5	11,0	175		23
5 x 2,5	12,0	230		32
5x4	13,0	320		42
5x6	14,5	435		54
5 x 10	18,0	670		75
3 x 16 + 2G10	20,0	865		100
3 x 25 + 2G16	24,5	1 315		127
3 x 35 + 2G16	26,0	1 680		158
XX1				
3 x 50 + 2G25	30,5	2 250		192
3 x 70 + 2G35	35,0	3 160		246
3 x 95 + 2G50	41,0	4 485		298
3 x 120 + 2G70	46,0	5 875		346
3 x 150 + 2G70	49,0	6 835		399
3 x 185 + 2G95	53,5	7 900		456
3 x 240 + 2G120	61,0	11 115		538
LXZ1				
1 x 25	11,0	125		107
1 x 50	12,0	195		165
1 x 95	17,0	355		264
1 x 150	21,0	525		358
1 x 240	25,5	830		492

Other compositions are available, contact inform@cabelte.pt for information.

(1) Phase conductors sector shape.

(2) Installation in free air or on perforated cable tray, horizontal or vertical.

Only one circuit is considered.

Cables with 2 and 3 conductors: 2 charged conductors.

Cables with 4 and 5 conductors: 3 charged conductors.

For compositions of 4 conductors, the same characteristics apply if the fourth conductor is the earth conductor or neutral conductor.

LOW VOLTAGE CABLE

APPLICATION

Fire resistance, halogen-free, high security cable, for rated voltages up to 0,6/1kV. For power supply to priority security systems that should be maintained in function during a fire. Suitable for indoor use, fixed installations, in public areas such as hospitals, hotels, shopping malls, airports, underground railway networks, tunnels, communication centres, and, in general, in all places where it is required a high degree of protection of persons and assets or/and with a large number of people and electrical/electronic equipment.

CABLE DESIGNATION

Cu/MICA/XLPE/LSHF: XZ1(frs, zh) • FXZ1(frs,zh)

F – Flexible

CONSTRUCTION CHARACTERISTICS

Conductor

Copper (plain annealed): stranded class 2 or flexible class 5, circular.

Insulation

Mica tapes, XLPE – (Cross-linked polyethylene).

Oversheath

LSHF – Low Smoke Halogen Free thermoplastic compound, fire retardant, type ST8.

COLOUR AND CABLE MARKING

Orange or Black upon request. Oversheath marked at regular intervals with the following information: CABELTE <Cable designation> <n.º cond.> x <cross-section> 0,6/1kV <year of manufacture> <metric marking>

IDENTIFICATION OF INSULATED CONDUCTORS

N.º of conductors		2	3	4	5
Insulation colouring (HD 308.S2)	With earth conductor	-	GYE–BU–BN	GYE–BN–BK–GY	GYE–BU–BN–BK–GY
	Without earth conductor	BU–BN	BN–BK–GY	BU–BN–BK–GY	BU–BN–BK–GY–BK

Insulation colour for single core cables – Black.

GENERAL CHARACTERISTICS

Construction and test standards	IEC 60228 • IEC 60502-1
Rated voltage U ₀ /U	0,6 / 1 kV
Test voltage	3,5 kV a.c. 5 minutes
Conductor maximum operating temperature	90° C
Maximum short-circuit temperature	250°C (t ≤ 5s)
Minimum bending radius (mm) (permanent, after installation) (during installation)	4xd if d<25 • 6xd if d≥25 6xd if d<25 • 9xd if d≥25
Maximum pulling force over conductor (N)	50 x S

S – conductor cross-section (mm²)

d – cable outer diameter (mm)



We reserve the right to modify, at any time, without any obligation and without prior notice, the specifications and other technical data in this document, which must be confirmed when ordering.



GENERAL CHARACTERISTICS

Flame retardant	IEC 60332-1-2 • EN 60332-1-2 (cable vertically mounted, length of charred cable ≤ 540 mm)
Fire retardant (frt)	IEC 60332-3-24 • EN 60332-3-24 (bunch of cables vertically mounted on a ladder, length of charred cable ≤ 2,5 m)
Fire resistant (frs)	IEC 60331-21 (750°C, charge circuit, time ≥ 90 minutes)
Halogen free (zh)	
Low smoke	IEC 61034-2 • EN 61034-2 (cable light transmittance ≥ 60%)
Low toxicity	IEC 60754-1 • EN 50267-2-1 (halogen acid gas content ≤ 0,5%)
Low corrosivity	IEC 60754-2 • EN 50267-2-3 (pH ≥ 4,3 • conductivity ≤ 10µS/mm)

ELECTRICAL AND DIMENSIONAL CHARACTERISTICS

Cable composition n.º cond. x cross-section (mm²)	Approximate outer diameter (mm)	Approximate weight (kg/km)	Current carrying capacity In open air(1) T = 30° C (A)	
			2 charged conductors	3 charged conductors
XZ1				
1 x 10	9,5	150	86	
1 x 16	10,5	210	115	
1 x 25	12,0	310	161	141
1 x 35	13,0	405	200	176
1 x 50	14,5	530	242	216
1 x 70	16,5	805	310	279
1 x 95	18,0	995	377	342
1 x 120	20,0	1 235	437	400
1 x 150	21,5	1 500	504	464
1 x 185	24,0	1 865	575	533
1 x 240	26,5	2 400	679	634
1 x 300	29,5	3 010	783	736
2 x 1,5	11,0	140	26	
2 x 2,5	12,0	175	36	
2x4	13,0	225	49	
2x6	14,0	280	63	
2 x 10	15,5	385	86	
2 x 16	18,0	545	115	
2 x 25	21,0	810	149	
3 x 1,5	11,5	160	26	
3 x 2,5	12,0	175	36	
3x4	14,0	270	49	
3x6	14,5	335	63	
3 x 10	16,5	480	86	
4 x 1,5	12,5	190		23
4 x 2,5	13,5	240		32
4x4	15,0	325		42
4x6	16,0	410		54
4 x 10	18,0	595		75
4 x 16	21,0	850		100

LOW VOLTAGE CABLE

Cable composition n.º cond. x cross-section (mm ²)	Approximate outer diameter (mm)	Approximate weight (kg/km)	Current carrying capacity In open air(1) T = 30° C (A)	
			2 charged conductors	3 charged conductors
3 x 16 + 1 x 10	20,0	800		100
3 x 25 + 1 x 16	23,5	1 205		127
3 x 35 + 1 x 16	25,5	1 525		158
3 x 50 + 1 x 25	29,0	2 050		192
3 x 70 + 1 x 35	35,5	2 870		246
3 x 95 + 1 x 50	37,5	3 875		298
3 x 120 + 1 x 70	42,5	4 965		346
5 x 1,5	13,5	225		23
5 x 2,5	14,5	295		32
5x4	16,5	390		42
5x6	17,5	500		54
5 x 10	19,5	730		75
5 x 16	23,0	1 055		100
3 x 25 + 2G16	25,5	1 390		127
3 x 35 + 2G16	31,0	2 320		158
3 x 50 + 2G25	27,0	3 160		192
3 x 70 + 2G35	35,5	4 485		246
3 x 95 + 2G50	40,5	5 875		298

Other compositions are available, contact inform@cabelte.pt for information.

(1) Installation in free air or on perforated cable tray, horizontal or vertical.

Only one circuit is considered.

Cables with 2 and 3 conductors: 2 charged conductors.

Cables with 4 and 5 conductors: 3 charged conductors.

For compositions of 4 conductors, the same characteristics apply if the fourth conductor is the earth conductor or neutral conductor.

LOW VOLTAGE CABLE

APPLICATION

Fire resistance, halogen-free, high security cable, for rated voltages up to 0,6/1kV. For power supply to priority security systems that should be maintained in function during a fire. Suitable for indoor use, fixed installations, in public areas such as hospitals, hotels, shopping malls, airports, underground railway networks, tunnels, communication centres, and, in general, in all places where it is required a high degree of protection of persons and assets or/and with a large number of people and electrical/electronic equipment.

CABLE DESIGNATION

Cu/Silicone/LSHF: SZ1(frs,zh) • SZ1-K(frs,zh)

K-Flexible

CONSTRUCTION CHARACTERISTICS

Conductor

Copper (plain annealed): solid class 1 or stranded class 2 or class5 (flexible), circular.

Insulation

Silicone rubber.

Oversheath

LSHF – Low Smoke Halogen Free thermoplastic compound, fire retardant, type ST8.

COLOUR AND CABLE MARKING

Orange. Oversheath marked at regular intervals with the following information:

CABELTE <Cable designation> <n.º cond.> x <cross-section> 0,6/1kV <year of manufacture> <metric marking>

IDENTIFICATION OF INSULATED CONDUCTORS

N.º of conductors		2	3	4	5
Insulation colouring (HD 308.S2)	With earth conductor	-	GYE-BU-BN	GYE-BN-BK-GY	GYE-BU-BN-BK-GY
	Without earth conductor	BU-BN	BN-BK-GY	BU-BN-BK-GY	BU-BN-BK-GY-BK

Insulation colour for single core cables – Black.

GENERAL CHARACTERISTICS

Construction and test standards	IEC 60228 IEC 60502-1
Rated voltage U ₀ /U	0,6 / 1 kV
Test voltage	3,5 kV a.c. 5 minutes
Conductor maximum operating temperature	90°C
Maximum short-circuit temperature	250°C (t ≤ 5s)
Minimum bending radius (permanent, after installation)	6xd
During laying higher value should be consider.	
Maximum pulling force over conductor (N)	50 x S

S – conductor cross-section (mm²) • d – cable outer diameter (mm)



GENERAL CHARACTERISTICS

Flame retardant	IEC 60332-1-2 • EN 60332-1-2 (cable vertically mounted, length of charred cable ≤ 540 mm)
Fire retardant (frt)	IEC 60332-3-24 • EN 60332-3-24 (bunch of cables vertically mounted on a ladder, length of charred cable ≤ 2,5 m)
Fire resistant (frs)	IEC 60331-21 (750°C, charge circuit, time ≥ 90 minutes)
Halogen free (zh)	
Low smoke	IEC 61034-2 • EN 61034-2 (cable light transmittance ≥ 60%)
Low toxicity	IEC 60754-1 • EN 50267-2-1 (halogen acid gas content ≤ 0,5%)
Low corrosivity	IEC 60754-2 • EN 50267-2-3 (pH ≥4,3 • conductivity ≤ 10µS/mm)

ELECTRICAL AND DIMENSIONAL CHARACTERISTICS

Cable composition n.º cond. x cross-section (mm²)	Approximate outer diameter (mm)	Approximate weight (kg/km)	Current carrying capacity In open air(1) T = 30° C (A)	
			2 charged conductors	3 charged conductors
SZ1-K				
1 x 1,5	6,0	55		
1 x 2,5	6,5	70		
1x4	7,5	90		
1x6	8,0	115		
2 x 1,5	9,0	120	26	
2 x 2,5	10,0	150	36	
2x4	11,0	195	49	
2x6	12,5	260	63	
3 x 1,5	9,5	140	26	
3 x 2,5	10,5	185	36	
3x4	11,5	240	49	
3x6	13,0	330	63	
4 x 1,5	11,0	165		23
4 x 2,5	12,0	225		32
4x4	12,5	295		42
4x6	14,0	410		54
5 x 1,5	11,0	200		23
5 x 2,5	12,0	265		32
5x4	13,5	355		42
5x6	14,5	495		54

Other compositions are available, contact inform@cabelte.pt for information.

(1) Installation in free air or on perforated cable tray, horizontal or vertical.

Only one circuit is considered.

Cables with 2 and 3 conductors: 2 charged conductors.

Cables with 4 and 5 conductors: 3 charged conductors.

For compositions of 4 conductors, the same characteristics apply if fourth conductor is the earth conductor or neutral conductor.

LOW VOLTAGE CABLE

APPLICATION

Control cable for rated voltage up to 0,6/1kV. Suitable for indoor or outdoor fixed installations, protected or not. Particularly indicated where flexibility is required, for example, in installations with complex geometry paths.

CABLE DESIGNATION

Cu / PVC / PVC: VV-K

CONSTRUCTION CHARACTERISTICS

Conductor

Copper (plain annealed): Circular, flexible, class 5.

Insulation

PVC – (Polyvinyl chloride), type A.

Oversheath

PVC – (Polyvinyl chloride), type ST 1.

COLOUR AND CABLE MARKING

Black.

Oversheath marked at regular intervals with the following information:

CABELTE VV-K <n.º cond.> x <cross-section> 0,6/1kV <year of manufacture> <metric marking>

IDENTIFICACIÓN DE LOS CONDUCTORES AISLADOS

N.º of conductors	6 to 37	
Insulation colouring (HD 308.S2)	With earth conductor	Black and numbered + GN/YE
	Without earth conductor	Black and numbered

GENERAL CHARACTERISTICS

	IEC 60228
Construction and test standards	IEC 60502-1 UNE 21123-1
Rated voltage U ₀ /U	0,6/1kV
Test voltage	3,5 kV a.c. 5 minutes
Conductor maximum operating temperature	70°C
Maximum short-circuit temperature	160°C (t ≤ 5s)
Minimum bending radius (mm)	5d
Maximum pulling force over conductor (N)	Pulling grip via oversheath: 3 x d ₂
Flame retardant	IEC 60332-1-2 • EN 60332-1-2 (cable vertically mounted, length of charred cable ≤ 540 mm)

d – cable outer diameter (mm)



ELECTRICAL AND DIMENSIONAL CHARACTERISTICS

Cable composition n.º cond. x cross-section (mm ²)	Approximate outer diameter (mm)	Approximate weight (kg/km)	Current carrying capacity In open air ⁽¹⁾ , T = 30° C (A)
5 x 1,5	12,5	220	13
6 x 1,5	13,5	250	12
7 x 1,5	13,5	260	12
8 x 1,5	15,0	335	12
10 x 1,5	16,5	350	10
12 x 1,5	17,0	405	10
14 x 1,5	18,0	455	9
16 x 1,5	19,0	515	9
19 x 1,5	20,0	575	8
24 x 1,5	23,0	715	7
30 x 1,5	24,5	865	6
37 x 1,5	26,5	1 040	6
5 x 2,5	14,0	285	18
6 x 2,5	15,0	335	16
7 x 2,5	15,5	350	16
8 x 2,5	17,5	455	16
10 x 2,5	18,5	460	13
12 x 2,5	19,5	550	13
14 x 2,5	20,5	635	12
16 x 2,5	21,5	720	12
19 x 2,5	23,0	805	11
24 x 2,5	26,0	990	10
30 x 2,5	27,5	1 215	8
37 x 2,5	29,5	1 415	8

(1) Only one cable installed.

LOW VOLTAGE CABLE

APPLICATION

Control cable for rated voltage up to 0,6/ 1kV. Suitable for indoor or outdoor fixed installations, protected or not.

CABLE DESIGNATION

CU / XLPE / PVC: XV

CONSTRUCTION CHARACTERISTICS

Conductor

Copper (plain annealed): Circular, stranded, class 2.

Insulation

XLPE – (Cross-linked polyethylene).

Oversheath

PVC – (Polyvinyl chloride), type ST 2.

COLOUR AND CABLE MARKING

Black. Oversheath marked at regular intervals with the following information:

CABELTE XV <n.º cond.> x <cross-section> 0,6/1kV <year of manufacture> <metric marking>

IDENTIFICACIÓN DE LOS CONDUCTORES AISLADOS

N.º of conductors	6 to 37	
Insulation colouring (HD 308.S2)	With earth conductor	Black and numbered + GN/YE
	Without earth conductor	Black and numbered

GENERAL CHARACTERISTICS

Construction and test standards	IEC 60228 IEC 60502-1
Rated voltage U ₀ /U	0,6/1kV
Test voltage	3,5 kV a.c. 5 minutes
Conductor maximum operating temperature	90°C
Maximum short-circuit temperature	250°C (t ≤ 5s)
Minimum bending radius (mm)	5d
Maximum pulling force over conductor (N)	Pulling grip via oversheath: 3 x d
Flame retardant	IEC 60332-1-2 • EN 60332-1-2 (cable vertically mounted, length of charred cable ≤ 540 mm)

d – cable outer diameter (mm)



ELECTRICAL AND DIMENSIONAL CHARACTERISTICS

Cable composition n.° cond. x cross-section (mm ²)	Approximate outer diameter (mm)	Approximate weight (kg/km)	Current carrying capacity In open air ⁽¹⁾ , T = 30° C (A)
5 x 1,5	11,0	180	18
6 x 1,5	11,5	215	16
7 x 1,5	11,5	220	16
8 x 1,5	13,2	265	16
10 x 1,5	14,3	280	13
12 x 1,5	14,7	320	13
14 x 1,5	15,5	360	12
16 x 1,5	16,2	405	12
19 x 1,5	17,1	460	11
24 x 1,5	19,8	570	9
30 x 1,5	21,0	685	8
37 x 1,5	22,6	820	8
5 x 2,5	12,0	245	24
6 x 2,5	12,6	285	21
7 x 2,5	12,6	295	21
8 x 2,5	14,5	355	21
10 x 2,5	15,8	385	17
12 x 2,5	16,3	440	17
14 x 2,5	17,1	500	16
16 x 2,5	18,0	565	16
19 x 2,5	18,9	650	14
24 x 2,5	22,0	805	13
30 x 2,5	23,3	975	11
37 x 2,5	25,2	1 180	11

(1) Only one cable installed.

LOW VOLTAGE CABLE

APPLICATION

Power supply for rated voltages up to 0,6/1kV in applications where electromagnetic protection is required. For fixed installations, protected or not, in industrial areas, power plants, substations and buildings.

CABLE DESIGNATION

CU / XLPE / CU / PVC: XHV · FXHV
 CU / XLPE / CU / LSHF: XHZ1 · FXHZ1
 F – Flexible

CONSTRUCTION CHARACTERISTICS

Conductor

Copper (plain annealed): stranded class 2 or flexible class 5, circular.

Insulation

XLPE – (Cross-linked polyethylene).

Bedding /Inner Sheath

PVC – (Polyvinyl chloride) or LSHF – Low Smoke Halogen Free thermoplastic compound.

Screen (shield)

Corrugated copper tape with nominal thickness of 0,1 mm.

Optionally the copper tape can be helically applied with an overlap.

Oversheath

Extruded PVC (Polyvinyl chloride), type ST2 or LSHF – Low Smoke Halogen Free thermoplastic compound, fire retardant, type ST8.

Fire retardant PVC, Oil resistance PVC can be supplied upon agreement.

COLOUR AND CABLE MARKING

Black or Blue (or other upon agreement).

Oversheath marked at regular intervals with the following information:

CABELTE <Cable designation> <n.^o cond.> x <cross-section> 0,6/1kV <year of manufacture> <metric marking>

IDENTIFICATION OF INSULATED CONDUCTORS

N. ^o of conductors		2	3	4	5
Insulation colouring (HD 308.S2)	With earth conductor	-	GNYE-BU-BN	GNYE-BN-BK-GY	GNYE-BU-BN-BK-GY
	Without earth conductor	BU-BN	BN-BK-GY	BU-BN-BK-GY	BU-BN-BK-GY-BK

For cables with more than 5 conductors or in alternative to the above colour code, black numbered insulation will be used.

GENERAL CHARACTERISTICS

Construction and test standards	IEC 60228 IEC 60502-1
Rated voltage U ₀ /U	0,6 / 1 kV
Test voltage	3,5 kV a.c. 5 minutes



GENERAL CHARACTERISTICS

Conductor maximum operating temperature	90°C
Maximum short-circuit temperature	250°C (t ≤ 5s)
Minimum bending radius (mm)	10 d
Maximum pulling force over conductor (N)	Copper – 50 x S
Flame retardant	IEC 60332-1-2 • EN 60332-1-2 (cable vertically mounted, length of charred cable ≤ 540 mm)

CHARACTERISTICS for XHZ1 and FXHZ1

Fire retardant (frt)	IEC 60332-3-24 • EN 60332-3-24 (bunch of cables vertically mounted on a ladder, length of charred cable ≤ 2,5 m)
Halogen free (zh)	
Low smoke	IEC 61034-2 • EN 61034-2 (cable light transmittance ≥ 60%)
Low toxicity	IEC 60754-1 • EN 50267-2-1 (halogen acid gas content ≤ 0,5%)
Low corrosivity	IEC 60754-2 • EN 50267-2-3 (pH ≥ 4,3 • conductivity ≤ 10µS/mm)

ADDITIONAL CHARACTERISTICS for XHV and FXHV

Fire retardant (frt)	IEC 60332-3-24 • EN 60332-3-24 (bunch of cables vertically mounted on a ladder, length of charred cable ≤ 2,5 m)
----------------------	--

S – conductor cross-section (mm²)
d – cable outer diameter (mm)

ELECTRICAL AND DIMENSIONAL CHARACTERISTICS

Cable composition n.º cond. x cross-section (mm ²)	Approximate outer diameter (mm)	FXHV Approximate weight (kg/km)	FXHZ1 Approximate weight (kg/km)
2x0,5	12,4	190	180
2x1,0	13,4	220	210
2x1,5	13,4	240	230
2x2,5	14,4	280	270
2x4	15,4	330	320
2x6	16,4	400	390
2x10	18,5	530	510
2x16	22,0	750	720
2x25	23,6	960	930
4x0,5	13,4	220	210
4x1,0	14,4	260	250
4x1,5	14,4	280	270
4x2,5	16,4	350	330
4x4	17,4	430	410
4x6	18,5	540	530
4x10	20,5	720	700
4x16	25,0	1 050	1 030
4x25	28,1	1 410	1 380

LOW VOLTAGE CABLE

Cable composition n.º cond. x cross-section (mm²)	Approximate outer diameter (mm)	FXHV Approximate weight (kg/km)	FXHZ1 Approximate weight (kg/km)
7x0,5	14,4	260	250
7x1,0	15,4	320	310
7x1,5	16,4	360	350
7x2,5	17,4	450	430
7x4	19,5	580	560
7x6	22,0	780	760
12x0,5	17,4	350	340
12x1,0	18,5	440	420
12x1,5	19,5	500	490
12x2,5	22,0	650	640
19x0,5	19,5	440	430
19x1,0	22,0	580	560
19x1,5	22,0	660	640
19x2,5	25,0	890	870
27x0,5	22,0	550	530
27x1,0	25,0	740	720
27x1,5	26,6	870	850
27x2,5	29,7	1 180	1 150
37x0,5	23,6	660	640
37x1,0	26,6	910	880
37x1,5	28,1	1 080	1 050

LOW VOLTAGE CABLE

APPLICATION

Power cables for energy supply used in industry, distribution boards and power stations, for rated voltage up to 0,6/1kV. The concentric conductor can be used as neutral* – protective or earthed conductor. Suitable for fixed installations indoor or outdoor.

* Depending of national regulations.

CABLE DESIGNATION

Cu / XLPE / Cu wire conductor / PVC: XOV • FXOV

F – Flexible

CONSTRUCTION CHARACTERISTICS

Conductor

Copper (plain annealed): stranded class 2, sector shape or circular, or circular flexible class 5.

Insulation

XLPE – (Cross-linked polyethylene).

Bedding/Inner sheath

PVC – (Polyvinyl chloride).

Neutral/Earth concentric conductor (CNE)

Single layer of plain annealed copper wires helically applied.

Oversheath

PVC – (Polyvinyl chloride).

COLOUR AND CABLE MARKING

Black. Oversheath marked at regular intervals with the following information:

CABELTE <Cable designation> <n.^o cond.> x <cross-section> 0,6/1kV <year of manufacture> <metric marking>

IDENTIFICATION OF INSULATED CONDUCTORS

N. ^o of conductors	2	3	4	5	
Insulation colouring (HD 308.S2)	With earth conductor	-	GNYE–BU–BN	GNYE–BN–BK–GY	GNYE–BU–BN–BK–GY
	Without earth conductor	BU–BN	BN–BK–GY	BU–BN–BK–GY	BU–BN–BK–GY–BK

GENERAL CHARACTERISTICS

Construction and test standards	IEC 60228 IEC 60502-1
Rated voltage U ₀ /U	0,6 / 1 kV
Test voltage	3,5 kV a.c. 5 minutes
Conductor maximum operating temperature	90°C
Maximum short-circuit temperature	250°C (t ≤ 5s)



GENERAL CHARACTERISTICS

Minimum bending radius (mm) (permanent, after installation) (during installation)	4xd if d<25 • 6xd if d≥25 • 8xd if sector shape cond. 6xd if d<25 • 9xd if d≥25 • 12xd if sector shape cond.
Maximum pulling force over conductor (N)	50 x S recomend not exceed 20000 N
Flame retardant	IEC 60332-1-2 • EN 60332-1-2 (cable vertically mounted, length of charred cable ≤ 540 mm)

d – cable outer diameter (mm)

S – conductor cross-section (mm²)

ELECTRICAL AND DIMENSIONAL CHARACTERISTICS

Cable composition n° cond. x cross-section (mm ²)	Approximate outer diameter (mm)	Approximate weight (kg/km)	Current carrying capacity, (1) in open air T = 30°C (A)
3x6/6	17,0	460	54
3 x 10 / 10	18,5	645	75
3 x 16 / 16	20,5	910	100
3 x 25 / 16	24,5	1 275	127
3 x 35 / 16	24,5	1 405	158
3 x 50 / 25	27,5	1 870	192
3 x 70 / 35	31,5	2 625	246
3 x 95 / 50	35,5	3 560	298
3 x 120 / 70	39,0	4 520	346
3 x 150 / 70	43,0	5 395	395
3 x 185 / 95	47,0	6 815	450
4x6/6	17,5	525	54
4 x 10 / 10	19,5	755	75
4 x 16 / 16	22,5	1 100	100
4 x 25 / 16	26,0	1 530	127
4 x 35 / 16	27,5	1 780	158
4 x 50 / 25	31,5	2 455	192
4 x 70 / 35	36,0	3 370	246
4 x 95 / 50	39,5	4 570	298
4 x 120 / 70	44,5	5 760	346
4 x 150 / 70	46,5	6 625	395

Other compositions are available, contact inform@cabelte.pt for information.

(1) Current ratings for 3 phase systems.

Sector shape conductors for phase conductors with cross-section higher than 25 mm².

APPLICATION

Power transmission and distribution cable for rated voltage up to 0,6/1kV, with 3 or 4 insulated conductors. Suitable for indoor and outdoor fixed installations, protected or not, in industrial areas, buildings and similar applications.

CABLE DESIGNATION

Al / PVC / Cu concentric conductor / PVC: AKKJ

CONSTRUCTION CHARACTERISTICS

Conductor

Aluminium (plain annealed), stranded class 2, sector shaped.

Insulation

PVC.

Concentric conductor

Single layer of plain annealed copper wires and a copper binder tape, helically applied.

Oversheath

PVC – (Polyvinyl chloride) fire retardant.

COLOUR AND CABLE MARKING

Black.

Oversheath marked at regular intervals with the following information:

CABELTE <Cable designation> <n° cond.> x <cross-section> 1kV <year of manufacture> <metric marking>

IDENTIFICATION OF INSULATED CONDUCTORS

N.º of conductors	3	4
Insulation colouring (HD 308.S2)	BN-BK-GY	BU-BN-BK-GY

GENERAL CHARACTERISTICS

Construction and test standards	IEC 60228 • EN 60228 HD 603 S1
Rated voltage U ₀ /U	0,6 / 1 kV
Test voltage	3,5 kV a.c. 5 minutes
Conductor maximum operating temperature	70°C
Maximum short-circuit temperature	160 °C (t ≤ 5s)
Maximum pulling force over conductor (N)	30 x S
Flame retardant	IEC 60332-1-2 • EN 60332-1-2 (cable vertically mounted, length of charred cable ≤ 540 mm)
Flame retardant	IEC 60332-3-23 • EN 60332-3-23 - Category B (bunch of cables vertically, length of charred cable ≤ 2,5 m).

S – conductor cross-section (mm²)



ELECTRICAL AND DIMENSIONAL CHARACTERISTICS

Cable composition n.º cond. x cross-section (mm ²)	Approximate outer diameter (mm)	Approximate weight (kg/km)	Current carrying capacity, (1) in open air T = 30°C (A)
AKKJ			
3X50/15	27,0	970	124
3X70/21	30,0	1280	158
3X95/29	35,0	1710	190
3X120/41	37,5	2160	220
3X150/41	41,0	2500	252
3X185/57	45,0	3250	289
3X240/72	50,5	4010	339
3X300/88	56,0	5100	377
4X50/15	30,0	1220	124
4X70/21	34,5	1640	158
4X95/29	39,5	2180	190
4X120/41	42,5	2670	220
4X150/41	46,5	3140	252
4X185/57	51,0	3920	289
4X240/72	57,5	5060	339
4X300/88	63,5	6370	377

(1) Normal operation, single cable laid in air, maximum conductor temperature = 70°C, protected from solar radiation.

LOW VOLTAGE CABLE

APPLICATION

Single and three core power distribution cables, for rated voltage up to 0,6/1kV.
Suitable for fixed installations protected or not.

CABLE DESIGNATION

Cu / XLPE / CNE / PVC • Al / XLPE / CNE / PVC
Cu / XLPE / SNE / PVC • Al / XLPE / SNE / PVC
Cu / XLPE / CNE / LSHF • Al / XLPE / CNE / LSHF
Cu / XLPE / SNE / LSHF • Al / XLPE / SNE / LSHF

CONSTRUCTION CHARACTERISTICS

Conductor

Copper (plain annealed): Circular, stranded, class 2;
Aluminium: Circular, solid class 1.

Insulation

XLPE – (Cross-linked polyethylene), type GP8.

Assembly and bedding for 3 phase cables

Synthetic tape bedding over conductors and fillers.

Neutral/Earth concentric conductor

CNE – Single layer of plain annealed copper wires helically applied;

SNE – Single layer of annealed copper wires:

Neutral conductor • wires are covered by an extruded polymeric compound – colour blue.

Earth continuity conductor • Bare wires.

String separators • Non-hygroscopic, located on either side of the group of the bare copper wires.

Oversheath

PVC – (Polyvinyl chloride), type 9;

or LSHF – Low Smoke Halogen Free thermoplastic compound, fire retardant, type LTS 1.

COLOUR AND CABLE MARKING

Black. Oversheath marked at regular intervals with the following information:

ELECTRIC CABLE 600/1000V < cable standard > CABELTE < n.º cond. > x < cross-section > Al* < year of manufacture > < order of manufacture > < metric marking >

* If Cu – not identified.

IDENTIFICATION OF INSULATED CONDUCTORS

N.º of conductors	1	3
Insulation colouring	Brown	Brown-Black-Grey

GENERAL CHARACTERISTICS

Construction and test standards	BS EN 60228 BS 7870-3.11 (CNE / PVC cables) BS 7870-3.21 (SNE / PVC cables) BS 7870-3.12 (CNE / LSHF cables) BS 7870-3.22 (SNE / LSHF cables)
---------------------------------	---



We reserve the right to modify, at any time, without any obligation and without prior notice, the specifications and other technical data in this document, which must be confirmed when ordering.



GENERAL CHARACTERISTICS

Rated voltage U_0/U	0,6 / 1 kV
Test voltage	3,5 kV a.c. 5 minutes 500V d.c. 1 minute (between earth/neutral), for SNE
Conductor maximum operating temperature	90°C
Maximum short-circuit temperature	250 °C (t ≤ 5s)
Minimum bending radius	15 x d if cond = 1 • 12 x d if cond > 1
Maximum pulling force over conductor (N)	Copper – 50 x S Aluminium – 30 x S
Flame retardant	BS EN 60332-1-2 (cable vertically mounted, length of charred cable ≤ 540 mm)

ADDITIONAL CHARACTERISTICS FOR LSHF CABLES

Fire retardant	BS EN 60332-3-24 (bunch of cables vertically mounted on a ladder, length of charred cable ≤ 2,5 m)
Halogen free	
Low smoke	BS EN 61034-2 (cable light transmittance ≥ 60%)
Low toxicity	BS EN 50267-2-1 (halogen acid gas content ≤ 0,5%)
Low corrosivity	BS EN 50267-2-3 (pH ≥ 4,3 • conductivity ≤ 10 μ S/mm)

ELECTRICAL AND DIMENSIONAL CHARACTERISTICS

CNE cables

Cable composition n.° cond. x cross-section (mm ²)	Conductor material	Approximate outer diameter (mm)	Approximate weight (kg/km)	Maximum d.c. resistance @ 20°C (Ω /km)	
				Phase conductor	CNE
*1x4	Cu	8,5	140	4,61	4,8
1x16		12,0	370	1,15	1,2
1x25		14,0	550	0,727	0,76
3x16		21,0	840	1,15	1,2
3x25		24,5	1 190	0,727	0,76
1x25	Al	13,0	300	1,2	1,3
1x35		14,0	390	0,868	0,91
3x25		23,0	650	1,2	1,3
3x35		25,0	820	0,868	0,91

* – only for PVC cables.

LOW VOLTAGE CABLE

SNE Cables

Cable composition n.° cond. x cross-section (mm ²)	Conductor material	Approximate outer diameter (mm)	Approximate weight (kg/km)	Maximum d.c. resistance @ 20°C (Ω/km)		
				Phase conductor	Neutral conductor	Earth conductor
*1x4	Cu	10,0	190	4,61	4,8	4,8
1x16		14,0	530	1,15	1,2	1,2
1x25		16,0	710	0,727	0,76	1,2
3x25		25,0	1 360	0,727	0,76	1,2
3x35		28,5	1 900	0,524	0,55	0,76
1x25	Al	15,0	490	1,20	1,2	1,2
1x35		16,0	610	0,868	0,76	1,2
3x25		23,5	830	1,2	1,2	1,2
3x35		26,0	1 030	0,868	0,76	1,20

* - only for PVC cables.

LOW VOLTAGE CABLE

APPLICATION

Single and three core cables, with concentric conductor, rated voltage 0,6/1kV. Used for power distribution networks. Can be supplied with the telemetry cable used for telemetry measurements – smart grids.

CABLE DESIGNATION

Branchement cable.

Branchement cable + Cable Téléreport.

CONSTRUCTION CHARACTERISTICS

Conductor

Solid aluminum conductors.

Insulation

XLPE – (Cross-linked polyethylene).

Assembly and bedding for 3 phase cables

PVC – (Polyvinyl chloride).

Neutral/Earth concentric conductor (CNE)

Single layer of plain annealed copper wires helically applied and continuity tape, applied in counter-helix.

Oversheath

PVC – (Polyvinyl chloride).

Telemetry cable

Cable Téléreport: armoured telephone cable with 1 quad, used to transmit the readings of energy consumption and deliver energy to a remote unit. Cable Téléreport is stranded with the Branchement cable.

COLOUR AND CABLE MARKING

Black. Oversheath marked at regular intervals with the following information:

Marking of Branchement cable

ELECTRIC CABLE 0,6/1kV CABELTE <n.º cond.> x <cross-section> AL / 22CU <n.º manufacturing batch> <year of manufacture> <metric marking>

Marking of Telemetry cable

TÉLÉREPORT ARMÉ CABELTE <n.º cond.> x <cross-section> AL / 22CU <n.º manufacturing batch> NF C 33-400

IDENTIFICATION OF INSULATED CONDUCTORS

N.º of conductors	1	3
Insulation colouring (HD 308.S2)	BN or BK or GY	BN-BK-GY

GENERAL CHARACTERISTICS

Construction and test standards	EDF HM-27/03/139B
Rated voltage U ₀ /U	0,6 / 1 kV
Test voltage	3,5 kV a.c. 5 minutes
Conductor maximum operating temperature	90°C



GENERAL CHARACTERISTICS

Maximum short-circuit temperature	250°C (t ≤ 5s)
Minimum bending radius	15 x d if cond = 1 • 12 x d if cond > 1
Maximum pulling force over conductor (N)	30 x S
Flame retardant	IEC 60332-1-2 • EN 60332-1-2 (cable vertically mounted, length of charred cable ≤ 540 mm)

S – conductor cross-section (mm²)

d – cable outer diameter (mm)

DIMENSIONAL CHARACTERISTICS

Câble branchement

Cable composition n.º cond. x cross-section (mm ²)	Approximate outer diameter (mm)	Approximate weight (kg/km)
1 x 35 Al / 22 Cu	14	400
1 x 35 Al / 22 Cu + Téléreport	24	530
3 x 35 Al / 22 Cu	25	1 000
3 x 35 Al / 22 Cu + Téléreport	35	1 150

LOW VOLTAGE CABLE

APPLICATION

Cable for power supply, for rated voltage up to 0,6/1kV. Suitable for outdoor fixed installations when it is necessary to protect the cable against mechanical aggression or against rodents threat. Can be laid in free air, install in ducts or directly buried.

Excellent mechanical protection during laying, installation and service.

CABLE DESIGNATION

Cu / XLPE / STA / PVC: XAV · FXAV

Cu / XLPE / SWA / PVC: XRV · FXRV

Al / XLPE / STA / PVC: LXAV

Al / XLPE / SWA / PVC: LXR

F – Flexible • STA – Steel tape armour • SWA – Steel wire armour

CONSTRUCTION CHARACTERISTICS

Conductor

Copper (plain annealed): solid class 1 or rigid stranded class 2 or class 5 (flexible), circular or sector shaped.
Aluminium: stranded class 2, circular or sector shaped.

Insulation

XLPE – (Cross-linked polyethylene).

Bedding /Inner Sheath

PVC – (Polyvinyl chloride)

Armour

Two steel tapes (A) helical applied – galvanized tapes upon request.

Steel galvanized wires (R) helical applied.

For single core cables steel is substituted by aluminium tapes or wires (1A or 1R).

Oversheath

PVC (Polyvinyl chloride), type ST 2.

COLOUR AND CABLE MARKING

Black (or other upon request). Oversheath marked at regular intervals with the following information:

CABELTE <Cable designation> <n.º cond.> x <cross-section> 0,6/1kV <year of manufacture> <metric marking>

IDENTIFICATION OF INSULATED CONDUCTORS

N.º of conductors		2	3	4	5
Insulation colouring (HD 308.S2)	With earth conductor	-	GNYE-BU-BN	GNYE-BN-BK-GY	GNYE-BU-BN-BK-GY
	Without earth conductor	BU-BN	BN-BK-GY	BU-BN-BK-GY	BU-BN-BK-GY-BK

GENERAL CHARACTERISTICS

Construction and test standards	IEC 60228 IEC 60502-1
Rated voltage U ₀ /U	0,6 / 1 kV
Test voltage	3,5 kV a.c. 5 minutes



We reserve the right to modify, at any time, without any obligation and without prior notice, the specifications and other technical data in this document, which must be confirmed when ordering.



GENERAL CHARACTERISTICS

Conductor maximum operating temperature	90°C
Maximum short-circuit temperature	250°C (t ≤ 5s)
Minimum bending radius (mm)	8 x d if SWA • 15 x d if STA
Maximum pulling force over conductor (N)	Copper – 50 x S Aluminium – 30 x S
Flame retardant	IEC 60332-1-2 • EN 60332-1-2 (cable vertically mounted, length of charred cable ≤ 540 mm)
S – conductor cross-section (mm ²)	
d – cable outer diameter (mm)	

ADDITIONAL CHARACTERISTICS *

Fire retardant (frt)	IEC 60332-3-24 • EN 60332-3-24 (bunch of cables vertically mounted on a ladder, length of charred cable ≤ 2,5 m)
----------------------	--

Oil resistant, Hidrocarbon resistance

*Can be supplied upon agreement.

ELECTRICAL AND DIMENSIONAL CHARACTERISTICS

Cable composition n.º cond. x cross-section (mm ²)	Approximate outer diameter (mm)	Approximate weight (kg/km)	Current carrying capacity Installation directly buried (1) Ts = 20°C (A)	
			2 charged conductors	3 charged conductors
X1AV / X1RV				
1 x 10	13,0 / 12,5	265 / 260	104	87
1 x 16	13,5 / 13,5	335 / 330	136	113
1 x 25	15,5 / 15,0	450 / 445	173	144
1 x 35	16,5 / 17,0	555 / 600	208	174
1 x 50	18,0 / 18,5	695 / 740	247	206
1 x 70	20,0 / 20,5	915 / 970	304	254
1 x 95	21,5 / 23,0	1 180 / 1 290	360	301
1 x 120	23,5 / 24,5	1 440 / 1 560	410	343
1 x 150	25,0 / 26,5	1 710 / 1 850	463	387
1 x 185	26,5 / 28,0	2 080 / 2 230	518	434
1 x 240	29,5 / 31,0	2 660 / 2 820	598	501
1 x 300	33,0 / 35,0	3 350 / 3 610	677	565
1 x 400	36,0 / 38,5	4 210 / 4 530		
1 x 500	40,0 / 42,5	5 170 / 5 510		
XAV / XRV				
2 x 1,5	11,5 / 12,5	220 / 300	37	
2 x 2,5	12,5 / 13,5	260 / 340	48	
2x4	13,5 / 14,5	315 / 405	63	
2x6	14,5 / 16,5	380 / 585	80	
2 x 10	16,5 / 18,5	525 / 770	104	
2 x 16	18,5 / 20,5	690 / 960	136	
2 x 25	22,0 / 24,5	990 / 1 460	173	

LOW VOLTAGE CABLE

Cable composition n.º cond. x cross-section (mm ²)	Approximate outer diameter (mm)	Approximate weight (kg/km)	Current carrying capacity Installation directly buried (1) Ts = 20°C (A)	
			2 charged conductors	3 charged conductors
2 x 35 (1)	20,0 / 22,5	980 / 1 420	208	
2 x 50 (1)	22,0 / 25,0	1 270 / 1 780	247	
2 x 70 (1)	25,0 / 29,0	1 720 / 2 490	304	
3 x 1,5	12,0 / 13,0	240 / 320	37	
3 x 2,5	13,0 / 14,0	290 / 375	48	
3x4	14,0 / 16,0	360 / 560	63	
3x6	15,0 / 17,0	440 / 660	80	
3 x 10	17,5 / 19,5	620 / 880	104	
3 x 16	19,5 / 22,0	835 / 1 250	136	
4 x 1,5	13,0 / 14,0	275 / 365		31
4 x 2,5	13,5 / 15,5	330 / 535		41
4x4	15,0 / 17,0	415 / 640		53
4x6	16,0 / 18,0	520 / 765		66
4 x 10	18,5 / 20,5	740 / 1 020		87
4 x 16	21,0 / 23,5	1 020 / 1 480		113
3 x 16 + 1 G 10	20,5 / 23,0	960 / 1 400		113
3 x 25 + 1 x 16	24,0 / 27,0	1 390 / 1 930		144
3 x 35 + 1 x 16 (1)	26,0 / 29,0	1 600 / 2 220		174
3 x 50 + 1 x 25 (1)	29,0 / 32,0	2 110 / 2 780		206
3 x 70 + 1 x 35 (1)	33,5 / 37,0	2 890 / 3 910		254
3 x 95 + 1 x 50 (1)	39,0 / 41,5	4 190 / 5 000		301
3 x 120 + 1 x 70 (1)	42,5 / 46,0	5 150 / 6 460		343
3 x 150 + 1 x 70 (1)	46,5 / 49,5	6 200 / 7 590		387
3 x 185 + 1 x 95 (1)	48,5 / 52,0	7 640 / 9 100		434
3 x 240 + 1 x 120 (1)	57,0 / 60,5	9 670 / 11 380		501
LXI1AV / LXI1RV				
1 x 16	13,5 / 13,5	240 / 235	104	87
1 x 25	15,5 / 15,0	305 / 300	133	111
1 x 35	16,5 / 17,0	350 / 395	160	134
1 x 50	17,5 / 18,0	410 / 455	188	160
1 x 70	19,5 / 20,0	510 / 565	233	197
1 x 95	21,5 / 23,0	615 / 725	275	234
1 x 120	23,0 / 24,0	730 / 850	314	266
1 x 150	25,0 / 26,5	850 / 990	359	300
1 x 185	27,0 / 28,5	1 010 / 1160	398	337
1 x 240	29,5 / 31,0	1 220 / 1380	458	388
1 x 300	33,0 / 35,0	1 480 / 1 540	520	400
1 x 400	36,0 / 38,5	1 810 / 2 130		
1 x 500	39,5 / 42,0	2 200 / 2540		
LXAV / LXRV				
4 x 16	21,0 / 23,5	635 / 1095		87
4 x 25	25,0 / 27,5	890 / 1460		111
4 x 35	26,0 / 29,0	915 / 1530		134



We reserve the right to modify, at any time, without any obligation and without prior notice, the specifications and other technical data in this document, which must be confirmed when ordering.



Cable composition n.º cond. x cross-section (mm ²)	Approximate outer diameter (mm)	Approximate weight (kg/km)	Current carrying capacity Installation directly buried (1) Ts = 20°C (A)	
			2 charged conductors	3 charged conductors
4 x 50	29,5 / 33,0	1 160 / 2050		160
4 x 70	35,0 / 37,5	1 830 / 2520		197
3 x 25 + 1 x 16	24,0 / 27,0	850 / 1400		111
3 x 35 + 1 x 16 (1)	26,0 / 29,0	890 / 1520		134
3 x 50 + 1 x 25 (1)	29,0 / 32,0	1 110 / 1800		160
3 x 70 + 1 x 35 (1)	33,5 / 37,0	1 470 / 2490		197
3 x 95 + 1 x 50 (1)	39,0 / 41,5	2 180 / 3040		234
3 x 120 + 1 x 70 (1)	42,5 / 46,0	2 610 / 3920		266
3 x 150 + 1 x 70 (1)	46,5 / 49,5	3 110 / 4590		300
3 x 185 + 1 x 95 (1)	48,5 / 52,0	3 620 / 5260		337
3 x 240 + 1 x 120 (1)	57,0 / 60,5	4 640 / 6350		388

Other compositions are available, contact inform@cabelte.pt for information.

(1) Phase conductors sector shape.

Only one circuit is considered.

Cables with 2 and 3 conductors: 2 charged conductors.

Cables with 4 and 5 conductors: 3 charged conductors.

For compositions of 4 conductors, the same characteristics apply if the fourth conductor is the earth conductor or neutral conductor.

LOW VOLTAGE CABLE

APPLICATION

Fire-retardant, halogen-free, high security cable, for rated voltages up to 0,6/1kV. For power transmission and distribution. Suitable for fixed outdoor connections; laid in free air or in ducts, when it is necessary to protect the cable against mechanical aggression or against rodents threat. Used in tunnels, underground railway, or in general in all places where it is required a high degree of protection of persons and assets or with a large number of people and electrical/electronic equipment.

CABLE DESIGNATION

Cu / XLPE / STA / LSHF: XAZ1 (frt,zh) • FXAZ1 (frt,zh)

Cu / XLPE / SWA / LSHF: XRZ1 (frt,zh) • FXRZ1 (frt,zh)

Al / XLPE / STA / LSHF: LXAZ1 (frt,zh)

Al / XLPE / SWA / LSHF: LXRZ1 (frt,zh)

F – Flexible • STA – Steel tape armour • SWA – Steel wire armour

CONSTRUCTION CHARACTERISTICS

Conductor

Copper (plain annealed): solid class 1 or stranded class 2 or flexible class 5, circular or sector shaped.

Aluminium: stranded class 2, circular or sector shaped.

Insulation

XLPE – (Cross-linked polyethylene).

Bedding /Inner Sheath

LSHF – Low Smoke Halogen Free thermoplastic compound.

Armour

Two steel tapes (A) helical applied - galvanized tapes if required;

Steel galvanized wires (R) helical applied;

For single core cables steel is substituted by aluminium tapes (1A or 1R).

Oversheath

LSHF – Low Smoke Halogen Free thermoplastic compound, fire retardant, type ST8.

COLOUR AND CABLE MARKING

Black (or other upon request). Oversheath marked at regular intervals with the following information:

CABELTE <Cable designation> <n.º cond.> x <cross-section> 0,6/1kV <year of manufacture> <metric marking>

IDENTIFICATION OF INSULATED CONDUCTORS

N.º of conductors		2	3	4	5
Insulation colouring (HD 308.S2)	With earth conductor	-	GNYE-BU-BN	GNYE-BN-BK-GY	GNYE-BU-BN-BK-GY
	Without earth conductor	BU-BN	BN-BK-GY	BU-BN-BK-GY	BU-BN-BK-GY-BK

GENERAL CHARACTERISTICS

Construction and test standards	IEC 60228 IEC 60502-1
Rated voltage U ₀ /U	0,6 / 1 kV



We reserve the right to modify, at any time, without any obligation and without prior notice, the specifications and other technical data in this document, which must be confirmed when ordering.



GENERAL CHARACTERISTICS

Test voltage	3,5 kV a.c. 5 minutes
Conductor maximum operating temperature	90°C
Maximum short-circuit temperature	250°C (t ≤ 5s)
Minimum bending radius (mm)	8 x d if SWA · 15 x d if STA
Maximum pulling force over conductor (N)	Copper – 50 x S Aluminium – 30 x S
Flame retardant	IEC 60332-1-2 · EN 60332-1-2 (cable vertically mounted, length of charred cable ≤ 540 mm)
Fire retardant (frt)	IEC 60332-3-24 · EN 60332-3-24 (bunch of cables vertically mounted on a ladder, length of charred cable ≤ 2,5 m)
Halogen free (zh)	
Low smoke	IEC 61034-2 · EN 61034-2 (cable light transmittance ≥ 60%)
Low toxicity	IEC 60754-1 · EN 50267-2-1 (halogen acid gas content ≤ 0,5%)
Low corrosivity	IEC 60754-2 · EN 50267-2-3 (pH ≥ 4,3 · conductivity ≤ 10µSmm ⁻¹)

S – conductor cross-section (mm²)

d – cable outer diameter (mm)

ELECTRICAL AND DIMENSIONAL CHARACTERISTICS

Cable composition n.º cond. x cross-section (mm ²)	Approximate outer diameter (mm)	Approximate weight (kg/km)	Current carrying capacity Installation directly buried (1) Ts = 20°C (A)	
			2 charged conductors	3 charged conductors
X1AZ1 / X1RZ1				
1 x 10	13,0 / 12,5	265 / 260	104	87
1 x 16	13,5 / 13,5	335 / 330	136	113
1 x 25	15,5 / 15,0	450 / 445	173	144
1 x 35	16,5 / 17,0	555 / 600	208	174
1 x 50	18,0 / 18,5	695 / 740	247	206
1 x 70	20,0 / 20,5	915 / 970	304	254
1 x 95	21,5 / 23,0	1 180 / 1 290	360	301
1 x 120	23,5 / 24,5	1 440 / 1 560	410	343
1 x 150	25,0 / 26,5	1 710 / 1 850	463	387
1 x 185	26,5 / 28,0	2 080 / 2 230	518	434
1 x 240	29,5 / 31,0	2 660 / 2 820	598	501
1 x 300	33,0 / 35,0	3 350 / 3 610	677	565
1 x 400	36,0 / 38,5	4 210 / 4 530		
1 x 500	40,0 / 42,5	5 170 / 5 510		
XAZ1 / XRZ1				
2 x 1,5	11,5 / 12,5	220 / 300	37	
2 x 2,5	12,5 / 13,5	260 / 340	48	
2x4	13,5 / 14,5	315 / 405	63	
2x6	14,5 / 16,5	380 / 585	80	
2 x 10	16,5 / 18,5	525 / 770	104	
2 x 16	18,5 / 20,5	690 / 960	136	

LOW VOLTAGE CABLE

Cable composition n.º cond. x cross-section (mm ²)	Approximate outer diameter (mm)	Approximate weight (kg/km)	Current carrying capacity Installation directly buried (1) Ts = 20°C (A)	
			2 charged conductors	3 charged conductors
2 x 25	22,0 / 24,5	990 / 1 460	173	
2 x 35 (1)	20,0 / 22,5	980 / 1 420	208	
2 x 50 (1)	22,0 / 25,0	1 270 / 1 780	247	
2 x 70 (1)	25,0 / 29,0	1 720 / 2 490	304	
3 x 1,5	12,0 / 13,0	240 / 320	37	
3 x 2,5	13,0 / 14,0	290 / 375	48	
3x4	14,0 / 16,0	360 / 560	63	
3x6	15,0 / 17,0	440 / 660	80	
3 x 10	17,5 / 19,5	620 / 880	104	
3 x 16	19,5 / 22,0	835 / 1 250	136	
4 x 1,5	13,0 / 14,0	275 / 365		31
4 x 2,5	13,5 / 15,5	330 / 535		41
4x4	15,0 / 17,0	415 / 640		53
4x6	16,0 / 18,0	520 / 765		66
4 x 10	18,5 / 20,5	740 / 1 020		87
4 x 16	21,0 / 23,5	1 020 / 1 480		113
3 x 16 + 1 G 10	20,5 / 23,0	960 / 1 400		113
3 x 25 + 1 x 16	24,0 / 27,0	1 390 / 1 930		144
3 x 35 + 1 x 16 (1)	26,0 / 29,0	1 600 / 2 220		174
3 x 50 + 1 x 25 (1)	29,0 / 32,0	2 110 / 2 780		206
3 x 70 + 1 x 35 (1)	33,5 / 37,0	2 890 / 3 910		254
3 x 95 + 1 x 50 (1)	39,0 / 41,5	4 190 / 5 000		301
3 x 120 + 1 x 70 (1)	42,5 / 46,0	5 150 / 6 460		343
3 x 150 + 1 x 70 (1)	46,5 / 49,5	6 200 / 7 590		387
3 x 185 + 1 x 95 (1)	48,5 / 52,0	7 640 / 9 100		434
3 x 240 + 1 x 120 (1)	57,0 / 60,5	9 670 / 11 380		501
LX1AZI / LX1RZI				
1 x 16	13,5 / 13,5	240 / 235	104	87
1 x 25	15,5 / 15,0	305 / 300	133	111
1 x 35	16,5 / 17,0	350 / 395	160	134
1 x 50	17,5 / 18,0	410 / 455	188	160
1 x 70	19,5 / 20,0	510 / 565	233	197
1 x 95	21,5 / 23,0	615 / 725	275	234
1 x 120	23,0 / 24,0	730 / 850	314	266
1 x 150	25,0 / 26,5	850 / 990	359	300
1 x 185	27,0 / 28,5	1 010 / 1160	398	337
1 x 240	29,5 / 31,0	1 220 / 1380	458	388
1 x 300	33,0 / 35,0	1 480 / 1 540	520	400
1 x 400	36,0 / 38,5	1 810 / 2 130		
1 x 500	39,5 / 42,0	2 200 / 2540		

Cable composition n.º cond. x cross-section (mm ²)	Approximate outer diameter (mm)	Approximate weight (kg/km)	Current carrying capacity Installation directly buried (1) Ts = 20°C (A)	
			2 charged conductors	3 charged conductors
LXAZI / LXRZI				
4 x 16	21,0 / 23,5	635 / 1095	87	
4 x 25	25,0 / 27,5	890 / 1460	111	
4 x 35 (1)	26,0 / 29,0	915 / 1530	134	
4 x 50 (1)	29,5 / 33,0	1 160 / 2050	160	
4 x 70 (1)	35,0 / 37,5	1 830 / 2520	197	
3 x 25 + 1 x 16	24,0 / 27,0	850 / 1400	111	
3 x 35 + 1 x 16 (1)	26,0 / 29,0	890 / 1520	134	
3 x 50 + 1 x 25 (1)	29,0 / 32,0	1 110 / 1800	160	
3 x 70 + 1 x 35 (1)	33,5 / 37,0	1 470 / 2490	197	
3 x 95 + 1 x 50 (1)	39,0 / 41,5	2 180 / 3040	234	
3 x 120 + 1 x 70 (1)	42,5 / 46,0	2 610 / 3920	266	
3 x 150 + 1 x 70 (1)	46,5 / 49,5	3 110 / 4590	300	
3 x 185 + 1 x 95 (1)	48,5 / 52,0	3 620 / 5260	337	
3 x 240 + 1 x 120 (1)	57,0 / 60,5	4 640 / 6350	388	

Other compositions are available, contact inform@cabelte.pt for information.

(1) Phase conductors sector shape.

Only one circuit is considered.

Cables with 2 and 3 conductors: 2 charged conductors.

Cables with 4 and 5 conductors: 3 charged conductors.

For compositions of 4 conductors, the same characteristics apply if the fourth conductor is the earth conductor or neutral conductor.

LOW VOLTAGE CABLE

APPLICATION

Cable for overhead power distribution systems mainly for public distribution, for rated voltage up to 0,6/1kV.

CABLE DESIGNATION

Cu / XLPE: XS (NP 3528, HD 626) • RZ (UNE 21030-2)

Al / XLPE: LXS (NP 3528, HD 626) • RZ Al (UNE 21030-1)

CONSTRUCTION CHARACTERISTICS

Phase conductors and public lighting conductors

Copper (plain annealed): Solid class 1; rigid stranded class 2.

Aluminium: stranded class 2.

Outer layer stranding direction: Right-hand (Z) for RZ and RZ Al.

Outer layer stranding direction: Left-hand (S) for XS and LXS.

Messenger neutral core

When applicable – Stranded aluminium alloy wires, cross-sections 29,5 mm²; 54,6 mm² and 80 mm²:

Outer layer stranding direction: Right-hand (Z) for RZ and RZ Al.

Insulation

XLPE – (Cross-linked polyethylene).

Assembly of cores

Cores are laid-up helically.

For cables having a messenger, the phase and auxiliary cores are cabled helically around it.

Stranding direction: Left-hand (S) for RZ and RZ Al.

Stranding direction: Right-hand (Z) for XS and LXS.

COLOUR AND CABLE MARKING

Black (or other upon request). Oversheath marked at regular intervals with the following information:

Neutral conductor: CABELTE <year of manufacture> <Cable designation> 0,6/1kV <composition>

Phase conductors: <Numbering of each conductor> <year of manufacture>

GENERAL CHARACTERISTICS

	NP 3528
Construction and test standards	HD 626 4-J e 6-J UNE 21030-1/2
Rated voltage U ₀ /U	0,6 / 1 kV
Test voltage	4 kV a.c. 5 minutes
Conductor maximum operating temperature	90°C
Maximum short-circuit temperature	250°C (t ≤ 5s)
Minimum bending radius (mm)	18 x d
Maximum pulling force over conductor (N)	With sleeve over copper conductors – 50 x S With sleeve over aluminium conductors – 30 x S
Excellent resistance to external agents	
S – conductor cross-section (mm ²) • d – cable outer diameter (mm)	



MECHANICAL AND ELECTRICAL CHARACTERISTICS

Material	Cross section (mm ²)	Minimum breaking load (daN)	Electrical resist. d.c. 20°C (Ω/km)
Copper	4	80	4,61
	6	120	3,08
	10	210	1,83
	16	–	1,15
	16	190	1,91
	25	300	1,2
Aluminium	35	420	0,868
	50	600	0,641
	70	840	0,443
	95	1 140	0,320
	150	1 800	0,206
	29,5	870	1,150
Aluminium alloy	54,6	1 660	0,630
	80	2 000	0,437

ELECTRICAL AND DIMENSIONAL CHARACTERISTICS

Cable composition n.º cond. x cross-section (mm ²)	Standards	Approximate outer diameter (mm)	Approximate weight (kg/km)	Maximum permissible current Installation in open air T = 40°C (A)
Copper XS · RZ				
2 x 2,5	UNE	9	65	25
2x4	UNE / NP	10	95	35
2x6	UNE / NP	12	135	55
2 x 10	UNE / NP	13	215	75
2 x 16	UNE	15	325	100
3x4	UNE	11	140	30
3 x 4 + 2 x 2,5	UNE	13	210	30
3x6	UNE / NP	13	205	50
3 x 6 + 2 x 2,5	UNE	14	270	48
3 x 10	NP	14	320	70
4x4	UNE	11	190	30
4x6	UNE / NP	14	275	50
4 x 6 + 2 x 2,5	UNE	19	345	48
4 x 10	UNE / NP	16	430	70
4 x 10 + 2 x 2,5	UNE	18	490	68
4 x 16	UNE	18	650	95
4 x 16 + 10	UNE	20	755	95
5x4	UNE	13	245	30
5 x 4 + 2 x 2,5	UNE	15	310	28
5x6	UNE	15	340	50
5 x 6 + 2 x 2,5	UNE	19	410	48
5 x 10	UNE	18	530	70
5 x 10 + 2 x 2,5	UNE	18	595	68
5 x 16	UNE	20	800	95
5 x 16 + 2 x 2,5	UNE	21	850	93

Cable composition n.º cond. x cross-section (mm ²)	Standards	Approximate outer diameter (mm)	Approximate weight (kg/km)	Maximum permissible current Installation in open air T = 40°C (A)
Aluminium LXS · RZ AL				
2 x 16	UNE / NP	15	130	85
2 x 25	UNE	18	200	110
1 x 25 / 54,6	UNE	22	310	110
3 x 16	NP	16	195	75
4 x 16	UNE / NP	18	260	75
5 x 16	NP	20	325	75
6 x 16	NP	22	390	75
4 x 25	UNE / NP	22	395	100
4 x 25 + 1 x 16	NP	24	460	100
4 x 25 + 2 x 16	NP	26	525	100
3 x 25 + 29,5	UNE	24	415	100
3 x 25 + 54,6	UNE / NP	23	500	100
3 x 25 + 54,6 + 1 x 16	NP	25	570	100
3 x 25 + 54,6 + 2 x 16	NP	27	635	100
4 x 35	NP	26	550	120
4 x 35 + 1 x 16	NP	27	615	120
4 x 35 + 2 x 16	NP	27	680	120
3 x 35 + 54,6	NP	27	620	120
3 x 35 + 54,6 + 1 x 16	NP	29	685	120
3 x 35 + 54,6 + 2 x 16	NP	32	750	120
4 x 50	UNE / NP	29	705	150
4 x 50 + 1 x 16	NP	30	770	150
4 x 50 + 1 x 25	NP	31	800	150
4 x 50 + 2 x 16	NP	31	835	150
4 x 50 + 2 x 25	NP	32	900	150
1 x 50 + 54,6	UNE	25	385	165
3 x 50 + 29,5	UNE	28	640	150
3 x 50 + 54,6	UNE / NP	30	735	150
3 x 50 + 54,6 + 1 x 16	NP	31	800	150
3 x 50 + 54,6 + 1 x 25	NP	32	835	150
3 x 50 + 54,6 + 2 x 16	NP	33	865	150
3 x 50 + 54,6 + 2 x 25	NP	34	935	150
4 x 70	NP	33	1 005	190
4 x 70 + 1 x 16	NP	34	1 070	190
4 x 70 + 1 x 25	NP	35	1 105	190
4 x 70 + 2 x 16	NP	36	1 135	190
4 x 70 + 2 x 25	NP	36	1 205	190
3 x 70 + 54,6	NP	33	960	190
3 x 70 + 54,6 + 1 x 16	NP	34	1 030	190
3 x 70 + 54,6 + 1 x 25	NP	35	1 060	190
3 x 70 + 54,6 + 2 x 16	NP	36	1 095	190
3 x 70 + 54,6 + 2 x 25	NP	36	1 160	190
4 x 95	NP	37	1 325	230

Cable composition n.º cond. x cross-section (mm ²)	Standards	Approximate outer diameter (mm)	Approximate weight (kg/km)	Maximum permissible current Installation in open air T = 40°C (A)
4 x 95 + 1 x 16	NP	38	1 390	230
4 x 95 + 1 x 25	NP	38	1 420	230
4 x 95 + 2 x 16	NP	40	1 455	230
4 x 95 + 2 x 25	NP	40	1 520	230
3 x 95 + 54,6	UNE / NP	37	1 200	230
3 x 95 + 50	UNE	37	1 880	230
3 x 95 + 54,6 + 1 x 16	NP	38	1 265	230
3 x 95 + 54,6 + 1 x 25	NP	38	1 300	230
3 x 95 + 54,6 + 2 x 16	NP	40	1 330	230
3 x 95 + 54,6 + 2 x 25	NP	40	1 400	230
3 x 150 + 95	UNE	44	1 800	305
3 x 150 + 80	UNE	43	1 755	305

MEDIUM VOLTAGE CABLES

SINGLE CORE CABLE

Unarmoured, Cross-linked Polyethylene Insulation – XLPE

- Standard IEC 60502-2
 - CU or AL / XLPE / CU / PVC or PE
- Flame retardant, Halogen free
 - CU or AL / XLPE / CU / PO
- Fire retardant, Halogen free
 - CU or AL / XLPE / CU / PO
- Standard BS 7870-4.10
 - AL / XLPE / CU / PE
- Aluminium screen
 - Cu or AL / XLPE / AL / PE
- Reinforced transversal watertightness
 - CU or AL / XLPE / CU / AL / PE

Unarmoured, Ethylene Propylene Rubber, Insulation – EPR

- Standard IEC 60502-2
 - CU or AL / EPR / CU / PVC or PE

Armoured, Cross-linked Polyethylene Insulation – XLPE

- Standard IEC 60502-2
 - CU or AL / XLPE / CU / ATA or AWA / PVC or PE

THREE CORE CABLE

Unarmoured, Cross-linked Polyethylene Insulation – XLPE

- Standard IEC 60502-2
 - CU or AL / XLPE / CU / PVC or PE
- Standard BS 7870-4.20
 - AL / XLPE / CU / PE

Armoured, Cross-linked Polyethylene Insulation – XLPE

- Standard IEC 60502-2
 - CU or AL / XLPE / CU / STA or SWA / PVC or PE

THREE CORE BUNDLE CABLE

Cross-linked Polyethylene Insulation – XLPE

- Without messenger
 - CU or AL / XLPE / CU / PVC or PE
- With messenger
 - AL / XLPE / CU / PVC or PE

HIGH VOLTAGE CABLES

- XHIOLE (cbe) • LXHIOLE (cbe)

MEDIUM VOLTAGE CABLE

APPLICATION

Cable for power distribution and power supply stations used in Utility and Industrial applications, for rated voltages up to 18/30kV. Suitable for fixed installations, indoor or outdoor, in open air on cable trays, or underground in ducts or directly buried.

CABLE DESIGNATION

Cu / XLPE / Cu Tape screen / PVC or PE: XHIV • XHIE

Cu / XLPE / Cu Wire screen / PVC or PE: XHIOV • XHIOE

Al / XLPE / Cu Tape screen / PVC or PE: LXHIV • LXHIE

Al / XLPE / Cu Wire screen / PVC or PE: LXHIOV • LXHIOE

Watertight constructions: XHIOE(be) or XHIOE(cbe)

Watertight constructions: LXHIOE(be) or LXHIOE(cbe)

CONSTRUCTION CHARACTERISTICS

Conductor

Plain annealed Copper or Aluminium, circular, stranded, class 2 per IEC 60228.

Insulation

Semi-conductive screen over the conductor, XLPE (cross-linked polyethylene) insulation and Semi-conductive screen over the insulation (strippable₁), applied by simultaneous extrusion in just one operation.

(1) Bonded upon agreement.

Metallic Screen

Copper wire screen – annealed copper wires helically wound and an equalising copper tape applied in an open counter-helix.

Plastic tape is applied over the screen.

Or Copper tape screen – a copper tape, standard thickness 0,1 mm helically applied with overlap.

Oversheath

Extruded PVC, type ST2 or PE type ST7.

Upon agreement, an extruded semi-conductive thin layer may be applied on the surface of the oversheath to facilitate the detection and location of defective points.

Watertightness option

(be) – Metallic screen longitudinally watertight. Assured by application of a waterblocking tape over the metallic screen. A waterblocking yarn under the screen may be considered.

(cbe) – Conductor and metallic screen longitudinally watertight. Conductor: assured by waterblocking yarn and / or tapes between wire layers; Metallic screen: assured by application of a waterblocking tape over metallic screen. A waterblocking yarn under the screen may be considered.

COLOUR AND CABLE MARKING

Black (other upon agreement).

Oversheath marked at regular intervals with the following information:

CABELTE <cable designation> 1 x <cond. cross-section>/<screen cross-section (if copper wires screen)>
<rated voltage> <order of manufacture>/<year of manufacture> <metric marking>





GENERAL CHARACTERISTICS

Construction and test standards	IEC 60228 • IEC 60502-2
Rated voltage U ₀ / U(Um)	3,6/6 (7,2) kV • 6/10 (12) kV • 8,7/15 (17,5) kV • 12/20 (24) kV • 18/30 (36) kV
Standard cross-section of wire screen	16 • 25 • 30 • 35
Test voltage	3,5 x U ₀
Conductor maximum operating temperature	90°C
Maximum short-circuit temperature	250°C (t ≤ 5s)
Minimum bending radius – during installation (mm)	20 x d
Minimum bending radius – after installation (mm)	15 x d
Maximum pulling force over conductor (N)	Copper – 50 x S Aluminium – 30 x S
Flame retardant (for PVC oversheath)	IEC 60332-1-2 • EN 60332-1-2 (cable vertically mounted, length of charred cable ≤ 540 mm)
Fire retardant (for PVC oversheath, upon agreement)	IEC 60332-3-24 • EN 60332-3-24 (bunch of cables vertically mounted on a ladder, length of charred cable ≤ 2,5 m)

S – conductor cross-section (mm²) • d – cable outer diameter (mm)

ELECTRICAL AND DIMENSIONAL CHARACTERISTICS

Copper conductor constructions

Voltage		Conductor cross-section (mm ²)	Diameter over insulation (mm)	Approx. outer diameter (mm)	Approx. weight XHIOV (kg/km)	Current carrying capacity 		Cond. max. short-circuit current, t=1s (kA)	Cond. DC resistance @ 20°C (Ω/km)	Inductance  (mH/km)	Capacitance (μF/km)
U ₀ / U (kV)	Um (kV)					In air (A)	Buried (A)				
Copper conductor											
3,6/6	7,2	25	13,0	20,0	655	157	160	3,6	0,7270	0,41	0,27
		35	14,0	21,0	770	190	191	5,0	0,5240	0,39	0,30
		50	15,0	22,5	905	229	227	7,5	0,3870	0,37	0,33
		70	16,5	24,0	1 120	286	278	10,0	0,2680	0,35	0,38
		95	18,5	26,0	1 400	350	333	13,6	0,1930	0,33	0,43
		120	20,0	28,0	1 675	406	380	17,2	0,1530	0,32	0,48
		150	21,0	29,0	1 930	461	426	21,5	0,1240	0,31	0,51
		185	22,5	30,5	2 305	526	481	26,5	0,0991	0,30	0,54
		240	25,5	33,5	2 885	630	560	34,3	0,0754	0,29	0,60
		300	28,5	37,0	3 555	731	634	42,9	0,0601	0,28	0,63
		400	32,0	40,5	4 505	851	721	57,2	0,0470	0,28	0,66
500	35,5	44,0	5 480	986	816	71,5	0,0366	0,27	0,69		
630	41,0	47,5	7 110	1 135	921	90,1	0,0283	0,27	0,76		
6/10	12	25	15,0	22,0	730	160	160	3,6	0,7270	0,43	0,22
		35	16,0	23,0	835	194	191	5,0	0,5240	0,41	0,24
		50	17,0	24,5	985	233	226	7,5	0,3870	0,39	0,27
		70	18,5	26,0	1 210	291	278	10,0	0,2680	0,36	0,30
		95	20,5	28,0	1 500	355	333	13,6	0,1930	0,35	0,34
		120	22,0	30,0	1 760	411	380	17,2	0,1530	0,33	0,37

MEDIUM VOLTAGE CABLE

Voltage		Conductor cross-section (mm ²)	Diameter over insulation (mm)	Approx. outer diameter (mm)	Approx. weight XHIOV (kg/km)	Current carrying capacity		Cond. max. short-circuit current, t=1s (kA)	Cond. DC resistance @ 20°C (Ω/km)	Inductance (mH/km)	Capacitance (μF/km)
U ₀ /U (kV)	U _m (kV)					In air (A)	Buried (A)				
Copper conductor											
6/10	12	150	23,0	31,0	2 040	466	426	21,5	0,1240	0,32	0,39
		185	24,5	32,5	2 405	532	480	26,5	0,0991	0,32	0,42
		240	27,0	35,5	2 990	634	559	34,3	0,0754	0,30	0,48
		300	30,0	38,0	3 640	733	633	42,9	0,0601	0,29	0,53
		400	33,0	41,5	4 580	853	720	57,2	0,0470	0,28	0,59
		500	36,0	44,5	5 530	987	817	71,5	0,0366	0,27	0,65
		630	41,5	48,0	7 140	1 136	920	90,1	0,0283	0,27	0,72
8,7/15	17,5	25	17,0	24,5	820	163	159	3,6	0,7270	0,45	0,18
		35	18,0	25,5	930	197	191	5,0	0,5240	0,43	0,20
		50	19,0	26,5	1 075	236	226	7,5	0,3870	0,41	0,21
		70	21,0	28,5	1 320	295	277	10,0	0,2680	0,38	0,24
		95	22,5	30,5	1 595	359	333	13,6	0,1930	0,36	0,27
		120	24,5	32,0	1 880	416	379	17,2	0,1530	0,35	0,29
		150	25,5	33,5	2 145	471	425	21,5	0,1240	0,34	0,31
		185	26,5	35,0	2 535	537	479	26,5	0,0991	0,33	0,33
		240	29,5	37,5	3 130	639	558	34,3	0,0754	0,32	0,38
		300	32,0	40,5	3 775	738	632	42,9	0,0601	0,30	0,42
		400	35,0	43,5	4 720	858	720	57,2	0,0470	0,29	0,46
		500	38,0	47,0	5 685	993	817	71,5	0,0366	0,28	0,51
		630	44,0	50,5	7 315	1 143	922	90,1	0,0283	0,28	0,56
12/20	24	35	20,0	27,5	1 025	199	191	5,0	0,5240	0,44	0,17
		50	21,0	29,0	1 170	239	226	7,5	0,3870	0,42	0,19
		70	23,0	31,0	1 425	298	277	10,0	0,2680	0,40	0,21
		95	24,5	32,5	1 705	362	332	13,6	0,1930	0,38	0,23
		120	26,5	34,5	2 000	419	379	17,2	0,1530	0,36	0,25
		150	27,5	35,5	2 270	474	424	21,5	0,1240	0,35	0,27
		185	28,5	37,0	2 660	541	479	26,5	0,0991	0,34	0,28
		240	31,5	39,5	3 250	643	557	34,3	0,0754	0,33	0,32
		300	34,0	42,5	3 920	742	631	42,9	0,0601	0,32	0,35
		400	37,0	45,5	4 880	862	720	57,2	0,0470	0,30	0,39
		500	40,0	49,0	5 855	997	817	71,5	0,0366	0,29	0,43
		630	46,0	52,5	7 510	1 153	928	90,1	0,0283	0,29	0,47
		18/30	36	50	26,0	34,5	1 445	244	225	7,5	0,3870
70	28,0			36,0	1 695	303	276	10,0	0,2680	0,43	0,16
95	29,5			38,0	2 015	368	331	13,6	0,1930	0,41	0,18
120	31,5			39,5	2 300	425	377	17,2	0,1530	0,39	0,19
150	32,5			41,0	2 600	481	422	21,5	0,1240	0,38	0,20
185	33,5			42,0	2 985	547	474	26,5	0,0991	0,37	0,21
240	36,5			45,0	3 620	649	556	34,3	0,0754	0,35	0,24
300	39,0			48,0	4 315	748	630	42,9	0,0601	0,34	0,26
400	42,0			51,0	5 305	868	718	57,2	0,0470	0,33	0,29
500	45,0			54,5	6 310	1 003	816	71,5	0,0366	0,32	0,31
630	51,0			58,0	8 010	1 154	923	90,1	0,0283	0,31	0,34

Aluminium conductor constructions

Voltage		Conductor cross-section (mm ²)	Diameter over insulation (mm)	Approx. outer diameter (mm)	Approx. weight LXHIOV (kg/km)	Current carrying capacity ⚡		Cond. max. short-circuit current, t=1s (kA)	Cond. DC resistance @ 20°C (Ω/km)	Inductance ⚡ (mH/km)	Capacitance (µF/km)
U _o / U (kV)	U _m (kV)					In air (A)	Buried (A)				
Aluminium conductor											
3,6/6	7,2	25	12,5	20,0	505	121	124	2,4	1,2000	0,41	0,27
		35	13,5	21,0	560	147	148	3,3	0,8680	0,39	0,30
		50	15,0	22,0	615	176	175	4,7	0,6410	0,37	0,33
		70	16,5	24,0	705	221	215	6,6	0,4430	0,35	0,38
		95	18,0	25,5	830	270	258	9,0	0,3200	0,33	0,42
		120	20,0	27,5	950	315	295	11,3	0,2530	0,32	0,47
		150	21,0	29,0	1 055	357	331	14,2	0,2060	0,31	0,51
		185	22,5	30,5	1 205	411	375	17,5	0,1640	0,30	0,55
		240	25,5	33,5	1 425	489	436	22,7	0,1250	0,29	0,60
		300	28,5	37,0	1 695	571	495	28,3	0,1000	0,28	0,63
		400	32,0	40,0	2 055	670	567	37,8	0,0778	0,28	0,66
500	35,0	43,5	2 450	782	649	47,2	0,0605	0,27	0,69		
630	40,0	49,0	3 040	925	746	59,5	0,0469	0,26	0,79		
6/10	12	25	14,5	22,0	575	124	124	2,4	1,2000	0,43	0,22
		35	15,5	23,0	630	150	148	3,3	0,8680	0,41	0,24
		50	17,0	24,5	700	179	175	4,7	0,6410	0,39	0,26
		70	18,5	26,0	795	225	215	6,6	0,4430	0,37	0,30
		95	20,0	28,0	925	274	258	9,0	0,3200	0,35	0,33
		120	22,0	29,5	1 040	319	295	11,3	0,2530	0,33	0,37
		150	23,0	31,0	1 165	361	330	14,2	0,2060	0,32	0,39
		185	24,5	32,5	1 305	415	374	17,5	0,1640	0,31	0,43
		240	27,0	35,0	1 525	493	435	22,7	0,1250	0,30	0,47
		300	30,0	38,0	1 785	573	495	28,3	0,1000	0,29	0,53
		400	32,5	41,0	2 125	671	567	37,8	0,0778	0,28	0,59
500	35,5	44,5	2 500	783	649	47,2	0,0605	0,28	0,65		
630	40,5	49,0	3 070	926	745	59,5	0,0469	0,27	0,75		
8,7/15	17,5	25	17,0	24,5	665	126	124	2,4	1,2000	0,45	0,18
		35	18,0	25,5	720	152	148	3,3	0,8680	0,43	0,19
		50	19,0	26,5	785	182	175	4,7	0,6410	0,41	0,21
		70	20,5	28,5	900	228	215	6,6	0,4430	0,38	0,24
		95	22,5	30,0	1 020	277	257	9,0	0,3200	0,36	0,27
		120	24,0	32,0	1 160	322	294	11,3	0,2530	0,35	0,29
		150	25,5	33,5	1 270	365	330	14,2	0,2060	0,34	0,31
		185	27,0	35,0	1 435	419	373	17,5	0,1640	0,33	0,34
		240	29,0	37,5	1 665	496	434	22,7	0,1250	0,32	0,37
		300	32,0	40,5	1 915	577	494	28,3	0,1000	0,30	0,42
		400	35,0	43,5	2 270	675	566	37,8	0,0778	0,29	0,46
500	38,0	46,5	2 655	787	648	47,2	0,0605	0,29	0,51		
630	42,5	51,5	3 240	929	745	59,5	0,0469	0,27	0,58		

MEDIUM VOLTAGE CABLE

Voltage		Conductor cross-section (mm ²)	Diameter over insulation (mm)	Approx. outer diameter (mm)	Approx. weight LXHIOV (kg/km)	Current carrying capacity		Cond. max. short-circuit current, t=1s (kA)	Cond. DC resistance @ 20°C (Ω/km)	Inductance (mH/km)	Capacitance (μF/km)
U _o / U (kV)	U _m (kV)					In air (A)	Buried (A)				
Aluminium conductor											
12/20	24	35	20,0	27,5	815	154	148	3,3	0,8680	0,44	0,17
		50	21,0	28,5	880	184	175	4,7	0,6410	0,42	0,18
		70	22,5	30,5	1 005	230	215	6,6	0,4430	0,40	0,21
		95	24,5	32,5	1 130	280	257	9,0	0,3200	0,38	0,23
		120	26,0	34,0	1 275	325	294	11,3	0,2530	0,36	0,25
		150	27,5	35,5	1 395	368	329	14,2	0,2060	0,35	0,27
		185	29,0	37,0	1 565	422	373	17,5	0,1640	0,34	0,29
		240	31,0	39,5	1 785	499	434	22,7	0,1250	0,33	0,32
		300	34,0	42,5	2 065	579	493	28,3	0,1000	0,32	0,35
		400	37,0	45,5	2 425	677	566	37,8	0,0778	0,30	0,39
500	40,0	48,5	2 825	789	647	47,2	0,0605	0,30	0,43		
630	44,5	53,5	3 425	930	744	59,5	0,0469	0,28	0,49		
18/30	36	50	26,0	34,0	1 155	188	174	4,7	0,6410	0,46	0,14
		70	27,5	36,0	1 275	234	214	6,6	0,4430	0,43	0,16
		95	29,5	37,5	1 435	285	256	9,0	0,3200	0,41	0,17
		120	31,0	39,5	1 575	330	293	11,3	0,2530	0,39	0,19
		150	32,5	41,0	1 725	373	327	14,2	0,2060	0,38	0,20
		185	34,0	42,5	1 890	427	371	17,5	0,1640	0,37	0,21
		240	36,0	45,0	2 150	504	432	22,7	0,1250	0,36	0,24
		300	39,0	48,0	2 460	584	491	28,3	0,1000	0,34	0,26
		400	42,0	51,0	2 850	681	564	37,8	0,0778	0,33	0,29
		500	45,0	54,0	3 275	792	646	47,2	0,0605	0,32	0,31
630	49,5	59,0	3 920	933	743	59,5	0,0469	0,30	0,35		

Other compositions are available, contact inform@cabelte.pt for information.

Current carrying capacity calculated considering the following conditions:

Maximum conductor temperature = 90°C

Cables in air: Ambient temperature = 30°C

Cables directly buried: Ground temperature = 20°C • Depth of laying = 0,7m • Thermal resistivity of soil = 1,0 K.m/W

MEDIUM VOLTAGE CABLE

APPLICATION

Cable for power distribution and power supply stations, halogen free and flame retardant used in Utility and Industrial applications, for rated voltages up to 18/30kV.

Applicable for installations where it is necessary to guarantee improved fire behaviour. Suitable for fixed installations, indoor or outdoor, in open air on cable trays, or underground in ducts or directly buried.

Special oversheath compound guarantees low water absorption properties and improved mechanical performance (tear resistance, tensile strength and elongation at break) compared to LSHF standard materials.

CABLE DESIGNATION

Cu / XLPE / Cu Tape screen / PO: XHIZ1

Al / XLPE / Cu Tape screen / PO: LXHIZ1

Cu / XLPE / Cu Wire screen / PO: XHIOZ1

Al / XLPE / Cu Wire screen / PO: LXHIOZ1

CONSTRUCTION CHARACTERISTICS

Conductor

Plain annealed Copper or Aluminium, circular, stranded, class 2 per IEC 60228.

Insulation

Semi-conductive screen over the conductor, XLPE (cross-linked polyethylene) insulation and semi-conductive screen over the insulation (strippable¹), applied by simultaneous extrusion in just one operation.

(1) Bonded upon agreement.

Metallic Screen

Copper wire screen – annealed copper wires helically wound and an equalising copper tape applied in an open counter-helix.

Plastic tape is applied over the screen.

Or Copper tape screen – a copper tape, standard thickness 0,1 mm helically applied with overlap.

Oversheath

Polyolefin type DMZ2 according to HD 620 S2 – LSHF – Low Smoke Halogen Free thermoplastic compound flame retardant.

COLOUR AND CABLE MARKING

Black (other upon agreement). Oversheath marked at regular intervals with the following information: CABELTE <cable designation> 1 x <cond. cross-section>/<screen cross-section (if copper wires screen)> <rated voltage> <order of manufacture>/<year of manufacture> <metric marking>

GENERAL CHARACTERISTICS

Construction and test standards	IEC 60228 IEC 60502-2 • HD 620 S2
Rated voltage U ₀ / U(Um)	3,6/6 (7,2) kV • 6/10 (12) kV • 8,7/15 (17,5) kV • 12/20 (24) kV • 18/30 (36) kV
Standard cross-section of wire screen	16 • 25 • 30 • 35
Test voltage	3,5 x U ₀
Conductor maximum operating temperature	90°C



We reserve the right to modify, at any time, without any obligation and without prior notice, the specifications and other technical data in this document, which must be confirmed when ordering.



Maximum short-circuit temperature	250°C (t ≤ 5s)
Minimum bending radius – during installation (mm)	20 x d
Minimum bending radius – after installation (mm)	15 x d
Maximum pulling force over conductor (N)	Copper – 50 x S Aluminium – 30 x S
Flame retardant	IEC 60332-1-2 • EN 60332-1-2 (cable vertically mounted, length of charred cable ≤ 540 mm)

S – conductor cross-section (mm²)

d – cable outer diameter (mm)

ELECTRICAL AND DIMENSIONAL CHARACTERISTICS

Dimensional and electrical characteristics can be consulted in the corresponding table (whether copper or aluminium conductors) of single core XLPE unarmoured cables.

MEDIUM VOLTAGE CABLE

APPLICATION

Cable for power distribution and power supply stations, halogen free and fire retardant used in Utility and Industrial applications, for rated voltages up to 18/30kV.

Applicable for installations of high security in relation to fire, namely tunnels, underground railways. Suitable for fixed installations, indoor or outdoor, in open air on cable trays, or underground in ducts or directly buried.

Special oversheath compound guarantees low water absorption properties and improved mechanical performance (tear resistance, tensile strength and elongation at break) compared to LSHF standard materials.

CABLE DESIGNATION

Cu / XLPE / Cu Tape screen / PO: XHIZ1 (frt,zh)

Al / XLPE / Cu Tape screen / PO: LXHIZ1 (frt,zh)

Cu / XLPE / Cu Wire screen / PO: XHIOZ1 (frt,zh)

Al / XLPE / Cu Wire screen / PO: LXHIOZ1 (frt,zh)

CONSTRUCTION CHARACTERISTICS

Conductor

Plain annealed Copper or Aluminium, circular, stranded, class 2 per IEC 60228.

Insulation

Semi-conductive screen over the conductor, XLPE (cross-linked polyethylene) insulation and semi-conductive screen over the insulation (strippable1), applied by simultaneous extrusion in just one operation.

(1) Bonded upon agreement.

Metallic Screen

Copper wire screen – annealed copper wires helically wound and an equalising copper tape applied in an open counter-helix.

Plastic tape is applied over the screen.

Or Copper tape screen – a copper tape, standard thickness 0,1 mm helically applied with overlap.

Bedding for Fire retardant category B

LSHF – Low Smoke Halogen Free thermoplastic compound, fire retardant.

Oversheath

Polyolefin type DMZ2 according to HD 620 S2 – LSHF – Low Smoke Halogen Free thermoplastic compound flame retardant or LSHF – Low Smoke Halogen Free thermoplastic compound, fire retardant type ST8 for fire retardant category C.

COLOUR AND CABLE MARKING

Black (other upon agreement). Oversheath marked at regular intervals with the following information: CABELTE <cable designation> 1 x <cond. cross-section>/<screen cross-section (if copper wires screen)> <rated voltage> <order of manufacture>/<year of manufacture> <metric marking>

GENERAL CHARACTERISTICS

Construction and test standards	IEC 60228
	IEC 60502-2 • HD 620 S2
Rated voltage U ₀ / U(Um)	3,6/6 (7,2) kV • 6/10 (12) kV • 8,7/15 (17,5) kV •
	12/20 (24) kV • 18/30 (36) kV



Standard cross-section of wire screen	16 • 25 • 30 • 35
Test voltage	3,5 x U ₀
Conductor maximum operating temperature	90°C
Maximum short-circuit temperature	250°C (t ≤ 5s)
Minimum bending radius – during installation (mm)	25 x d
Minimum bending radius – after installation (mm)	18 x d
Maximum pulling force over conductor (N)	Copper – 50 x S Aluminium – 30 x S
Flame retardant	IEC 60332-1-2 • EN 60332-1-2 (cable vertically mounted, length of charred cable ≤ 540 mm)
Fire retardant (frt)	IEC 60332-3-23 • EN 60332-3-23 – Category B or IEC 60332-3-24 • EN 60332-3-24 – Category C (bunch of cables vertically mounted on a ladder, length of charred cable ≤ 2,5 m)
Halogen free (zh)	
Low smoke	IEC 61034-2 • EN 61034-2 (cable light transmittance ≥ 60%)
Low toxicity	IEC 60754-1 • EN 50267-2-1 (halogen acid gas content ≤ 0,5%)
Low corrosivity	IEC 60754-2 • EN 50267-2-3 (pH ≥ 4,3 • conductivity ≤ 10μS/mm)

S – conductor cross-section (mm²) μ•μd – cable outer diameter (mm)

ELECTRICAL AND DIMENSIONAL CHARACTERISTICS

Copper conductor constructions for Fire Retardant Category B

Voltage		Conductor cross-section (mm ²)	Diameter over insulation (mm)	Approx. outer diameter (mm)	Approx. weight (kg/km)	Current carrying capacity (A)
U ₀ / U (kV)	U _m (kV)					
6/10	12	70	18,5	32,0	1 700	291
		95	20,0	33,5	2 010	355
		120	22,0	35,5	2 300	411
		150	23,0	36,5	2 590	466
		185	24,0	38,0	2 970	532
		240	27,0	41,0	3 590	634
		300	29,5	43,5	4 320	733
		400	32,5	47,0	5 240	853
		500	35,5	50,0	6 230	987
		630	39,0	53,5	7 710	1 136

MEDIUM VOLTAGE CABLE

√ Unarmoured · XLPE Insulation · Fire Retardant · Halogen Free

Voltage		Conductor cross-section (mm ²)	Diameter over insulation (mm)	Approx. outer diameter (mm)	Approx. weight (kg/km)	Current carrying capacity ⚡ (A)
U ₀ / U (kV)	U _m (kV)					
12/20	24	70	22,5	36,5	1 980	298
		95	24,5	38,0	2 290	362
		120	26,0	40,0	2 600	419
		150	27,0	41,0	2 890	474
		185	28,5	42,5	3 290	541
		240	31,0	45,0	3 920	643
		300	34,0	48,0	4 670	742
		400	36,5	51,0	5 610	862
		500	40,0	54,5	6 620	997
		630	43,0	58,0	8 120	1 153
18/30	36	70	27,5	41,5	2 330	303
		95	29,5	43,5	2 670	368
		120	31,0	45,0	2 980	425
		150	32,0	46,5	3 300	481
		185	33,5	47,5	3 700	547
		240	36,0	50,5	4 360	649
		300	39,0	53,5	5 140	748
		400	41,5	56,5	6 100	868
		500	45,0	60,0	7 130	1 003
		630	48,0	63,5	8 660	1 154

Aluminium conductor constructions for Fire Retardant Category B

Voltage		Conductor cross-section (mm ²)	Diameter over insulation (mm)	Approx. outer diameter (mm)	Approx. weight (kg/km)	Current carrying capacity ⚡ (A)
U ₀ / U (kV)	U _m (kV)					
6/10	12	70	18,0	31,5	1 290	225
		95	20,0	33,5	1 450	274
		120	21,5	35,0	1 590	319
		150	23,0	36,5	1 730	361
		185	24,5	38,0	1 900	415
		240	26,5	40,5	2 150	493
		300	29,5	43,5	2 450	573
		400	32,5	46,5	2 830	671
		500	35,5	50,0	3 250	783
		630	40,0	54,5	3 880	926

Voltage		Conductor cross-section (mm ²)	Diameter over insulation (mm)	Approx. outer diameter (mm)	Approx. weight (kg/km)	Current carrying capacity  (A)
U ₀ / U (kV)	U _m (kV)					
12/20	24	70	22,5	36,0	1 560	230
		95	24,0	38,0	1 720	280
		120	26,0	39,5	1 890	325
		150	27,0	41,0	2 030	368
		185	28,5	42,5	2 220	422
		240	31,0	45,0	2 470	499
		300	34,0	48,0	2 800	579
		400	36,5	51,0	3 200	677
		500	39,5	54,0	3 630	789
		630	44,0	59,0	4 300	930
18/30	36	70	27,5	41,5	1 920	234
		95	29,0	43,0	2 100	285
		120	31,0	45,0	2 270	330
		150	32,0	46,5	2 440	373
		185	33,5	48,0	2 620	427
		240	36,0	50,5	2 920	504
		300	39,0	53,5	3 260	584
		400	41,5	56,5	3 690	681
		500	44,5	59,5	4 150	792
		630	49,0	64,5	4 860	933

Other compositions are available, contact inform@cabelte.pt for information.

For cables with metallic screen of copper wires with cross-section of 16mm².

Current carrying capacity calculated considering the following conditions:

Maximum conductor temperature = 90°C

Cables in air, trefoil formation: Ambient temperature = 30°C

MEDIUM VOLTAGE CABLE

APPLICATION

Cable for power distribution and power supply stations used in Utility and Industrial applications, for rated voltages 6,35/11kV. Suitable for fixed installations, indoor or outdoor, in open air on cable trays, or underground in ducts or directly buried.

CABLE DESIGNATION

Al / XLPE / Cu Wire screen / PE: LSXHIOE(cbe)

CONSTRUCTION CHARACTERISTICS

Conductor

Solid aluminium conductor, circular, class 1 per BS EN 60228.

Insulation

Semi-conductive screen over the conductor, XLPE (cross-linked polyethylene) insulation and semi-conductive screen over the insulation (strippable or bonded), applied by simultaneous extrusion in just one operation.

Metallic Screen

Annealed copper wires, helically wound and an equalising copper tape applied in an open counter-helix.

Oversheath

Extruded MDPE.

Upon agreement, an extruded semi-conductive thin layer may be applied on the surface of the oversheath, to facilitate the detection and location of defective points.

Watertightness

(be) – Metallic screen longitudinally watertight. Assured by application of a semi-conductive waterblocking tape under the screen and a non-conductive waterblocking tape over the screen.

COLOUR AND CABLE MARKING

Red. Oversheath marked at regular intervals with the following information:

ELECTRIC CABLE 11000V BS7870-4.10 CABELTE 1 x <cond. cross-section> AL <year of manufacture> <metric marking>

GENERAL CHARACTERISTICS

Construction and test standards	BS EN 60228 BS 7870-4.10
Rated voltage U_0 / $U(U_m)$	6,35/11 (12) kV
Standard cross-section of wire screen	16 • 25 • 35 • 50 • 70 • 95
Test voltage	4 x U_0
Conductor maximum operating temperature	90°C
Maximum short-circuit temperature	250°C (t ≤ 5s)
Minimum bending radius – during installation (mm)	25 x d
Minimum bending radius – after installation (mm)	15 x d
Maximum pulling force over conductor (N)	30 x S

S – conductor cross-section (mm²) • d – cable outer diameter (mm)



We reserve the right to modify, at any time, without any obligation and without prior notice, the specifications and other technical data in this document, which must be confirmed when ordering.



DIMENSIONAL CHARACTERISTICS

Voltage		Conductor cross-section (mm ²)	Diameter over insulation (mm)	Approx. outer diameter (mm)	Approx. weight (kg/km)
U ₀ / U (kV)	U _m (kV)				
6,35/11	12	70	17,5	27,5	910
		95	19,0	29,5	1 010
		150	21,5	32,0	1 210
		185	23,5	34,0	1 370
		240	26,0	37,0	1 620
		300	28,0	38,5	1 790

MEDIUM VOLTAGE CABLE

APPLICATION

Cable for power distribution and power supply stations used in Utility and Industrial applications, for rated voltages up to 18/30kV. Suitable for fixed installations, indoor or outdoor, in open air on cable trays, or underground in ducts or directly buried.

CABLE DESIGNATION

Cu / XLPE / Al Tape Screen / PE: X1HIE

Al / XLPE / Al Tape Screen / PE: LX1HIE

CONSTRUCTION CHARACTERISTICS

Conductor

Plain annealed Copper or Aluminium, circular, stranded, class 2 per IEC 60228.

Insulation

Semi-conductive screen over the conductor, XLPE (cross-linked polyethylene) insulation and Semi-conductive screen over the insulation (strippable¹), applied by simultaneous extrusion in just one operation.

(1) Bonded upon agreement.

Metallic Screen

Aluminium copolymer coated tape, longitudinally applied, bonded to the oversheath. Cross-section area of tape in accordance with short circuit current.

A semi-conductive waterblocking tape is applied under the aluminium tape.

Oversheath

Extruded PE, type ST7.

COLOUR AND CABLE MARKING

Black (other upon agreement). Oversheath marked at regular intervals with the following information: CABELTE <cable designation> 1 x <cond. cross-section> <rated voltage> <order of manufacture> / <year of manufacture> <metric marking>

GENERAL CHARACTERISTICS

Construction and test standards	IEC 60228
	IEC 60502-2
Rated voltage U ₀ / U(Um)	3,6/6 (7,2) kV • 6/10 (12) kV • 8,7/15 (17,5) kV •
	12/20 (24) kV • 18/30 (36) kV
Test voltage	3,5 x U ₀
Conductor maximum operating temperature	90°C
Maximum short-circuit temperature	250°C (t ≤ 5s)
Minimum bending radius – during installation (mm)	25 x d
Minimum bending radius – after installation (mm)	20 x d
Maximum pulling force over conductor (N)	Copper – 50 x S
	Aluminium – 30 x S

S – conductor cross-section (mm²)

d – cable outer diameter (mm)

Several compositions are available, contact inform@cabelte.pt for information.



We reserve the right to modify, at any time, without any obligation and without prior notice, the specifications and other technical data in this document, which must be confirmed when ordering.



MEDIUM VOLTAGE CABLE

APPLICATION

Cable for power distribution and power supply stations used in Utility and Industrial applications, for rated voltages up to 18/30kV. Suitable for fixed installations, indoor or outdoor, in open air on cable trays, or underground in ducts or directly buried. Cable is both longitudinally and radially watertight and therefore best suitable for wet conditions.

CABLE DESIGNATION

Cu / XLPE / Cu Wire screen / Al tape / PE: XHIOLE(cbe)

Al / XLPE / Cu Wire screen / Al tape / PE: LXHIOLE(cbe)

CONSTRUCTION CHARACTERISTICS

Conductor

Plain annealed Copper or Aluminium, circular, stranded, class 2 per IEC 60228.

Insulation

Semi-conductive screen over the conductor, XLPE (cross-linked polyethylene) insulation and Semi-conductive screen over the insulation (strippable₁), applied by simultaneous extrusion in just one operation.

(1) Bonded upon agreement.

Metallic Screen

Annealed copper wires, helically wound and an equalising copper tape applied in an open counter-helix. Cross-section area of screen according to client request.

Oversheath

Aluminium copolymer coated tape, longitudinally applied, bonded to the extruded PE oversheath, type ST7. Upon agreement, an extruded semi-conductive thin layer may be applied on the surface of the oversheath, to facilitate the detection and location of defective points.

Watertightness

(cbe) – Conductor and metallic screen longitudinally watertight. Conductor: assured by waterblocking yarns and/or tapes between wire layers; Metallic screen: assured by application of a waterblocking tape over metallic screen. A waterblocking yarn under the screen may be considered.

L – Radial watertightness provided by the aluminium-coated tape.

COLOUR AND CABLE MARKING

Black (other upon agreement). Oversheath marked at regular intervals with the following information: CABELTE <cable designation> 1 x <cond. cross-section>/<screen cross-section (if copper wires screen)> <rated voltage> <order of manufacture>/<year of manufacture> <metric marking>

GENERAL CHARACTERISTICS

Construction and test standards	IEC 60228 IEC 60502-2
Rated voltage U ₀ / U(U _m)	3,6/6 (7,2) kV • 6/10 (12) kV • 8,7/15 (17,5) kV • 12/20 (24) kV • 18/30 (36) kV
Standard cross-section of wire screen	16 • 25 • 30 • 35
Test voltage	3,5 x U ₀
Conductor maximum operating temperature	90°C



Maximum short-circuit temperature	250°C (t ≤ 5s)
Minimum bending radius – during installation (mm)	25 x d
Minimum bending radius – after installation (mm)	20 x d
Maximum pulling force over conductor (N)	Copper – 50 x S Aluminium – 30 x S

S – conductor cross-section (mm²)

d – cable outer diameter (mm)

Several compositions are available, contact inform@cabelte.pt for information.

MEDIUM VOLTAGE CABLE

APPLICATION

Cable for power distribution and power supply stations used in Utility and Industrial applications, for rated voltages up to 18/30kV. Suitable for fixed installations, indoor or outdoor, in open air on cable trays, or underground in ducts or directly buried.

CABLE DESIGNATION

Cu / EPR / Cu Tape screen / PVC or PE: BHIV • BHIE

Cu / EPR / Cu Wire screen / PVC or PE: BHIOV • BHIOE

Al / EPR / Cu Tape screen / PVC or PE: LXHIV • LXHIE

Al / EPR / Cu Wire screen / PVC or PE: LBHIOV • LBHIOE

Watertight constructions: BHIOE(be) or BHIOE(cbe)

Watertight constructions: LBHIOE(be) or LBHIOE(cbe)

CONSTRUCTION CHARACTERISTICS

Conductor

Plain annealed Copper or Aluminium, circular, stranded, class 2 per IEC 60228.

Insulation

Semi-conductive screen over the conductor, HEPR (hard ethylene propylene rubber) insulation and Semi-conductive screen over the insulation (strippable¹), applied by simultaneous extrusion in just one operation.

(1) Bonded upon agreement.

Metallic Screen

Copper wire screen – annealed copper wires helically wound and an equalising copper tape applied in an open counter-helix.

Plastic tape is applied over the screen.

Or Copper tape screen – a copper tape, standard thickness 0,1 mm helically applied with overlap.

Oversheath

Extruded PVC, type ST2 or PE type ST7.

Upon agreement, an extruded semi-conductive thin layer may be applied on the surface of the oversheath to facilitate the detection and location of defective points.

Watertightness option

(be) – Metallic screen longitudinal watertight. Assured by application of a waterblocking tape over metallic screen. A waterblocking yarn under the screen may be considered.

(cbe) – Conductor and metallic screen longitudinal watertight. Conductor: assured by a waterblocking yarn and or tapes between wires layers; Metallic screen: assured by application of a waterblocking tape over metallic screen. A waterblocking yarn under the screen may be considered.

COLOUR AND CABLE MARKING

Black (other upon agreement).

Oversheath marked at regular intervals with the following information:

CABELTE <cable designation> 1 x <cond. cross-section>/<screen cross-section (if copper wires screen)>
<rated voltage> <order of manufacture>/<year of manufacture> <metric marking>



GENERAL CHARACTERISTICS

Construction and test standards	IEC 60228 • IEC 60502-2
Rated voltage U ₀ / U _m (Um)	3,6/6 (7,2) kV • 6/10 (12) kV • 8,7/15 (17,5) kV • 12/20 (24) kV • 18/30 (36) kV
Standard cross-section of wire screen	16 • 25 • 30 • 35
Test voltage	3,5 x U ₀
Conductor maximum operating temperature	105°C (90°C per IEC 60502-2)
Maximum short-circuit temperature	250°C (t ≤ 5s)
Minimum bending radius – during installation (mm)	20 x d
Minimum bending radius – after installation (mm)	15 x d
Maximum pulling force over conductor (N)	Copper – 50 x S Aluminium – 30 x S
Flame retardant (for PVC oversheath)	IEC 60332-1-2 (cable vertically mounted, length of charred cable ≤ 540 mm).
Fire retardant (for PVC oversheath, upon agreement)	IEC 60332-3-24 (bunch of cables vertically mounted on a ladder, length of charred cable ≤ 2,5 m)

S – conductor cross-section (mm²) • d – cable outer diameter (mm)

ELECTRICAL AND DIMENSIONAL CHARACTERISTICS

Copper conductor constructions

Voltage	Conductor cross-section	Diameter over insulation	Approx. outer diameter	Approx. weight BHIOV	Current carrying capacity		Cond. max. short-circuit current, t=1s	Cond. DC resistance @ 20°C	Inductance	Capacitance	
					In air	Buried					
U ₀ / U (kV)	Um (kV)	(mm ²)	(mm)	(mm)	(kg/km)	(A)	(A)	(kA)	(Ω/km)	(mH/km)	(µF/km)
3,6/6	7,2	25	13,0	20,0	689	153	159	3,6	0,727	0,41	0,343
		35	14,0	21,0	807	186	190	5,0	0,524	0,39	0,377
		50	15,0	22,5	945	224	225	7,5	0,387	0,37	0,411
		70	16,5	24,0	1 164	280	277	10,0	0,268	0,35	0,462
		95	18,5	26,0	1 453	343	334	13,6	0,193	0,33	0,529
		120	20,0	28,0	1 732	398	380	17,2	0,153	0,32	0,579
		150	21,0	29,0	1 989	454	425	21,5	0,124	0,31	0,613
		185	22,5	30,5	2 371	522	480	26,5	0,0991	0,30	0,663
		240	25,5	33,5	2 964	619	557	34,3	0,0754	0,29	0,731
		300	28,5	37,0	3 649	712	632	42,9	0,0601	0,28	0,762
		400	32,0	40,5	4 619	825	718	57,2	0,0470	0,28	0,803
500	35,5	44,0	5 614	960	814	71,5	0,0366	0,27	0,838		
630	41,0	47,5	7 303	1 109	920	90,1	0,0283	0,27	0,982		
6/10	12	25	15,0	22,0	778	153	159	3,6	0,727	0,43	0,276
		35	16,0	23,0	888	186	190	5,0	0,524	0,41	0,301
		50	17,0	24,5	1 042	224	225	7,5	0,387	0,39	0,326
		70	18,5	26,0	1 272	280	277	10,0	0,268	0,36	0,364
		95	20,5	28,0	1 573	343	334	13,6	0,193	0,35	0,414
		120	22,0	30,0	1 839	398	380	17,2	0,153	0,33	0,451

MEDIUM VOLTAGE CABLE

Voltage		Conductor cross-section (mm ²)	Diameter over insulation (mm)	Approx. outer diameter (mm)	Approx. weight BHIOV (kg/km)	Current carrying capacity		Cond. max. short-circuit current, t=1s (kA)	Cond. DC resistance @ 20°C (Ω/km)	Inductance (mH/km)	Capacitance (μF/km)
U ₀ /U (kV)	U _m (kV)					In air (A)	Buried (A)				
6/10	12	150	23,0	31,0	2 122	454	425	21,5	0,124	0,32	0,476
		185	24,5	32,5	2 495	522	480	26,5	0,0991	0,32	0,513
		240	27,0	35,5	3 089	619	557	34,3	0,0754	0,30	0,574
		300	30,0	38,0	3 756	712	632	42,9	0,0601	0,29	0,648
		400	33,0	41,5	4 711	825	718	57,2	0,0470	0,28	0,722
		500	36,0	44,5	5 674	960	814	71,5	0,0366	0,27	0,796
8,7/15	17,5	25	17,0	24,5	885	153	159	3,6	0,727	0,45	0,221
		35	18,0	25,5	1 000	186	190	5,0	0,524	0,43	0,240
		50	19,0	26,5	1 150	224	225	7,5	0,387	0,41	0,260
		70	21,0	28,5	1 408	280	277	10,0	0,268	0,38	0,298
		95	22,5	30,5	1 690	343	334	13,6	0,193	0,36	0,326
		120	24,5	32,0	1 988	398	380	17,2	0,153	0,35	0,364
		150	25,5	33,5	2 258	454	425	21,5	0,124	0,34	0,383
		185	26,5	35,0	2 651	522	480	26,5	0,0991	0,33	0,402
		240	29,5	37,5	3 266	619	557	34,3	0,0754	0,32	0,458
		300	32,0	40,5	3 923	712	632	42,9	0,0601	0,30	0,505
		400	35,0	43,5	4 885	825	718	57,2	0,0470	0,29	0,561
		500	38,0	47,0	5 867	960	814	71,5	0,0366	0,28	0,617
12/20	24	630	44,0	50,5	7 573	1 109	920	90,1	0,0283	0,28	0,728
		35	20,0	27,5	1 115	186	190	5,0	0,524	0,44	0,209
		50	21,0	29,0	1 266	224	225	7,5	0,387	0,42	0,225
		70	23,0	31,0	1 535	280	277	10,0	0,268	0,40	0,256
		95	24,5	32,5	1 824	343	334	13,6	0,193	0,38	0,280
		120	26,5	34,5	2 135	398	380	17,2	0,153	0,36	0,311
		150	27,5	35,5	2 410	454	425	21,5	0,124	0,35	0,326
		185	28,5	37,0	2 804	522	480	26,5	0,0991	0,34	0,342
		240	31,5	39,5	3 417	619	557	34,3	0,0754	0,33	0,388
		300	34,0	42,5	4 102	712	632	42,9	0,0601	0,32	0,426
		400	37,0	45,5	5 082	825	718	57,2	0,0470	0,30	0,472
		500	40,0	49,0	6 077	960	814	71,5	0,0366	0,29	0,518
18/30	36	630	46,0	52,5	7 815	1 109	920	90,1	0,0283	0,29	0,610
		50	26,0	34,5	1 601	224	225	7,5	0,387	0,46	0,174
		70	28,0	36,0	1 871	280	277	10,0	0,268	0,43	0,197
		95	29,5	38,0	2 204	343	334	13,6	0,193	0,41	0,213
		120	31,5	39,5	2 509	398	380	17,2	0,153	0,39	0,235
		150	32,5	41,0	2 817	454	425	21,5	0,124	0,38	0,246
		185	33,5	42,0	3 209	522	480	26,5	0,0991	0,37	0,257
		240	36,5	45,0	3 874	619	557	34,3	0,0754	0,35	0,289
		300	39,0	48,0	4 591	712	632	42,9	0,0601	0,34	0,316
		400	42,0	51,0	5 609	825	718	57,2	0,0470	0,33	0,348
		500	45,0	54,5	6 641	960	814	71,5	0,0366	0,32	0,379
		630	51,0	58,0	8 439	1 109	920	90,1	0,0283	0,31	0,443



We reserve the right to modify, at any time, without any obligation and without prior notice, the specifications and other technical data in this document, which must be confirmed when ordering.



Aluminium conductor constructions

Voltage		Conductor cross-section (mm ²)	Diameter over insulation (mm)	Approx. outer diameter (mm)	Approx. weight LBHIOV (kg/km)	Current carrying capacity ⚡		Cond. max. short-circuit current, t=1s (kA)	Cond. DC resistance @ 20°C (Ω/km)	Inductance ⚡ (mH/km)	Capacitance (µF/km)
U _o / U (kV)	U _m (kV)					In air (A)	Buried (A)				
3,6/6	7,2	25	12,5	20,0	536	119	123	2,4	1,20	0,41	0,326
		35	13,5	21,0	594	144	148	3,3	0,868	0,39	0,360
		50	15,0	22,0	656	174	175	4,7	0,641	0,37	0,411
		70	16,5	24,0	750	218	215	6,6	0,443	0,35	0,462
		95	18,0	25,5	879	266	259	9,0	0,320	0,33	0,512
		120	20,0	27,5	1 008	309	294	11,3	0,253	0,32	0,579
		150	21,0	29,0	1 114	352	330	14,2	0,206	0,31	0,613
		185	22,5	30,5	1 269	406	374	17,5	0,164	0,30	0,663
		240	25,5	33,5	1 506	483	434	22,7	0,125	0,29	0,731
		300	28,5	37,0	1 788	556	494	28,3	0,100	0,28	0,762
		400	32,0	40,0	2 170	651	566	37,8	0,0778	0,28	0,803
		500	35,0	43,5	2 579	763	648	47,2	0,0605	0,27	0,825
630	40,0	49,0	3 194	906	745	59,5	0,0469	0,26	0,956		
6/10	12	25	14,5	22,0	620	119	123	2,4	1,20	0,43	0,263
		35	15,5	23,0	679	144	148	3,3	0,868	0,41	0,289
		50	17,0	24,5	757	174	175	4,7	0,641	0,39	0,326
		70	18,5	26,0	858	218	215	6,6	0,443	0,37	0,364
		95	20,0	28,0	994	266	259	9,0	0,320	0,35	0,401
		120	22,0	29,5	1 120	309	294	11,3	0,253	0,33	0,451
		150	23,0	31,0	1 247	352	330	14,2	0,206	0,32	0,476
		185	24,5	32,5	1 393	406	374	17,5	0,164	0,31	0,513
		240	27,0	35,0	1 626	483	434	22,7	0,125	0,30	0,574
		300	30,0	38,0	1 901	556	494	28,3	0,100	0,29	0,648
		400	32,5	41,0	2 248	651	566	37,8	0,0778	0,28	0,710
		500	35,5	44,5	2 638	763	648	47,2	0,0605	0,28	0,784
630	40,5	49,0	3 235	906	745	59,5	0,0469	0,27	0,907		
8,7/15	17,5	25	17,0	24,5	730	119	123	2,4	1,20	0,45	0,221
		35	18,0	25,5	791	144	148	3,3	0,868	0,43	0,240
		50	19,0	26,5	861	174	175	4,7	0,641	0,41	0,260
		70	20,5	28,5	983	218	215	6,6	0,443	0,38	0,288
		95	22,5	30,0	1 116	266	259	9,0	0,320	0,36	0,326
		120	24,0	32,0	1 263	309	294	11,3	0,253	0,35	0,355
		150	25,5	33,5	1 383	352	330	14,2	0,206	0,34	0,383
		185	27,0	35,0	1 556	406	374	17,5	0,164	0,33	0,411
		240	29,0	37,5	1 795	483	434	22,7	0,125	0,32	0,449
		300	32,0	40,5	2 063	556	494	28,3	0,100	0,30	0,505
		400	35,0	43,5	2 437	651	566	37,8	0,0778	0,29	0,561
		500	38,0	46,5	2 840	763	648	47,2	0,0605	0,29	0,617
630	42,5	51,5	3 447	906	745	59,5	0,0469	0,27	0,700		

MEDIUM VOLTAGE CABLE

Voltage		Conductor cross-section (mm ²)	Diameter over insulation (mm)	Approx. outer diameter (mm)	Approx. weight LBHIOV (kg/km)	Current carrying capacity		Cond. max. short-circuit current, t=1s (kA)	Cond. DC resistance @ 20°C (Ω/km)	Inductance (mH/km)	Capacitance (μF/km)
U ₀ / U (kV)	U _m (kV)					In air (A)	Buried (A)				
12/20	24	35	20,0	27,5	905	144	148	3,3	0,868	0,44	0,209
		50	21,0	28,5	976	174	175	4,7	0,641	0,42	0,225
		70	22,5	30,5	1 110	218	215	6,6	0,443	0,40	0,248
		95	24,5	32,5	1 250	266	259	9,0	0,320	0,38	0,280
		120	26,0	34,0	1 404	309	294	11,3	0,253	0,36	0,303
		150	27,5	35,5	1 535	352	330	14,2	0,206	0,35	0,326
		185	29,0	37,0	1 715	406	374	17,5	0,164	0,34	0,349
		240	31,0	39,5	1 946	483	434	22,7	0,125	0,33	0,380
		300	34,0	42,5	2 246	556	494	28,3	0,100	0,32	0,426
		400	37,0	45,5	2 629	651	566	37,8	0,0778	0,30	0,472
		500	40,0	48,5	3 050	763	648	47,2	0,0605	0,30	0,518
		630	44,5	53,5	3 677	906	745	59,5	0,0469	0,28	0,587
18/30	36	50	26,0	34,0	1 312	174	175	4,7	0,641	0,46	0,174
		70	27,5	36,0	1 445	218	215	6,6	0,443	0,43	0,191
		95	29,5	37,5	1 625	266	259	9,0	0,320	0,41	0,213
		120	31,0	39,5	1 777	309	294	11,3	0,253	0,39	0,230
		150	32,5	41,0	1 942	352	330	14,2	0,206	0,38	0,246
		185	34,0	42,5	2 121	406	374	17,5	0,164	0,37	0,262
		240	36,0	45,0	2 397	483	434	22,7	0,125	0,36	0,284
		300	39,0	48,0	2 735	556	494	28,3	0,100	0,34	0,316
		400	42,0	51,0	3 155	651	566	37,8	0,0778	0,33	0,348
		500	45,0	54,0	3 609	763	648	47,2	0,0605	0,32	0,379
				630	49,5	59,0	4 293	906	745	59,5	0,0469

Current carrying capacity calculated considering the following conditions:

Maximum conductor temperature = 90°C

Cables in air: Ambient temperature = 30°C

Cables directly buried: Ground temperature = 20°C • Depth of laying = 0,7m • Thermal resistivity of soil = 1,0 K.m/W

MEDIUM VOLTAGE CABLE

APPLICATION

Cable for power distribution and power supply stations used in Utility and Industrial applications, for rated voltages up to 18/30kV. Suitable for fixed installations, directly buried. Good mechanical protection.

CABLE DESIGNATION

Cu / XLPE / Cu Tape screen / Aluminium Tape armour / PVC or PE: XHI1AV • XHI1AE
 Cu / XLPE / Cu Wire screen / Aluminium Tape armour / PVC or PE: XHIO1AV • XHIO1AE
 Al / XLPE / Cu Tape screen / Aluminium Tape armour / PVC or PE: LXHI1AV • LXHI1AE
 Al / XLPE / Cu Wire screen / Aluminium Tape armour / PVC or PE: LXHIO1AV • LXHIO1AE
 Cu / XLPE / Cu Tape screen / Aluminium Wire armour / PVC or PE: XHI1RV • XHI1RE
 Cu / XLPE / Cu Wire screen / Aluminium Wire armour / PVC or PE: XHIO1RV • XHIO1RE
 Al / XLPE / Cu Tape screen / Aluminium Wire armour / PVC or PE: LXHI1RV • LXHI1RE
 Al / XLPE / Cu Wire screen / Aluminium Wire armour / PVC or PE: LXHIO1RV • LXHIO1RE
 Watertight constructions XHIO1AE(be) or LXHIO1AE(cbe)
 Watertight constructions XHIO1RE(be) or LXHIO1RE(cbe)

CONSTRUCTION CHARACTERISTICS

Conductor

Plain annealed Copper or Aluminium, circular, stranded, class 2 per IEC 60228.

Insulation

Semi-conductive screen over the conductor, XLPE (cross-linked polyethylene) insulation and Semi-conductive screen over the insulation (strippable₁), applied by simultaneous extrusion in just one operation.

(1) Bonded upon agreement.

Metallic Screen

Copper wire screen – annealed copper wires helically wound and an equalising copper tape applied in an open counter-helix. Cross-section area of screen according to client request.

A wrapping plastic tape is applied over the screen.

Or Copper tape screen – a copper tape, standard thickness 0,1 mm helically applied with overlap.

Inner Sheath

Extruded PVC.

Armour

Two aluminium tapes helically applied.

Or Aluminium wires, helically applied, tightened with plastic tapes.

Oversheath

Extruded PVC, type ST2 or PE type ST7.

Watertightness option under inner sheath

(be) – Metallic screen longitudinally watertight. Assured by application of a waterblocking tape over the metallic screen. A waterblocking yarn under the screen may be considered.

(cbe) – Conductor and metallic screen longitudinally watertight. Conductor: assured by waterblocking yarns and/or tapes between wire layers; Metallic screen: assured by application of a waterblocking tape over metallic screen. A waterblocking yarn under the screen may be considered.



COLOUR AND CABLE MARKING

Black (other upon agreement).

Oversheath marked at regular intervals with the following information:

CABELTE <cable designation> 1 x <cond. cross-section>/<screen cross-section (if copper wires screen)> <rated voltage>
<order of manufacture>/<year of manufacture> <metric marking>

GENERAL CHARACTERISTICS

Construction and test standards	IEC 60228 • IEC 60502-2
Rated voltage U ₀ / U(Um)	3,6/6 (7,2) kV • 6/10 (12) kV • 8,7/15 (17,5) kV • 12/20 (24) kV • 18/30 (36) kV
Standard cross-section of wire screen	16 • 25 • 30 • 35
Test voltage	3,5 x U ₀
Conductor maximum operating temperature	90°C
Maximum short-circuit temperature	250°C (t ≤ 5s)
Minimum bending radius – during installation (mm)	20 x d
Minimum bending radius – after installation (mm)	15 x d
Maximum pulling force over conductor (N)	Copper – 50 x S • Aluminium – 30 x S
Flame retardant (for PVC oversheath)	IEC 60332-1-2 • EN 60332-1-2 (cable vertically mounted, length of charred cable ≤ 540 mm)
Fire retardant (for PVC oversheath, upon agreement)	IEC 60332-3-24 • EN 60332-3-24 (bunch of cables vertically mounted on a ladder, length of charred cable ≤ 2,5 m)



S – conductor cross-section (mm²) • d – cable outer diameter (mm)

ELECTRICAL AND DIMENSIONAL CHARACTERISTICS

Copper conductor constructions

Voltage		Conductor cross-section (mm ²)	Diameter over insulation (mm)	Approx. outer diameter (mm)	Approx. weight XHIO1AV (kg/km)	Current carrying capacity ⚡		Cond. max. short-circuit current, t=1s (kA)	Cond. DC resistance @ 20°C (Ω/km)	Inductance ⚡ (mH/km)	Capacitance (µF/km)
U ₀ / U (kV)	Um (kV)					In air (A)	Buried (A)				
Copper conductor											
3,6/6	7,2	25	13,0	25,5	960	164	164	3,6	0,7270	0,44	0,27
		35	14,0	26,5	1 080	198	196	5,0	0,5240	0,42	0,30
		50	15,0	27,5	1 230	238	231	7,2	0,3870	0,40	0,33
		70	16,5	29,5	1 470	296	282	10,0	0,2680	0,38	0,38
		95	18,5	31,0	1 760	360	338	13,6	0,1930	0,36	0,43
		120	20,0	32,5	2 035	417	384	17,2	0,1530	0,34	0,48
		150	21,0	34,0	2 325	470	428	21,5	0,1240	0,33	0,51
		185	22,5	35,5	2 700	535	481	26,5	0,0991	0,33	0,54
		240	25,5	38,5	3 340	635	557	34,3	0,0754	0,31	0,60
		300	28,5	42,0	4 050	729	625	42,9	0,0601	0,31	0,63
		400	32,0	45,5	5 045	844	708	57,2	0,0470	0,30	0,66
		500	35,5	49,0	6 070	971	797	71,5	0,0366	0,29	0,69
630	41,0	53,0	7 775	1109	892	90,1	0,0283	0,28	0,76		

MEDIUM VOLTAGE CABLE

Voltage		Conductor cross-section (mm ²)	Diameter over insulation (mm)	Approx. outer diameter (mm)	Approx. weight XHIO1AV (kg/km)	Current carrying capacity 		Cond. max. short-circuit current, t=1s (kA)	Cond. DC resistance @ 20°C (Ω/km)	Inductance  (mH/km)	Capacitance (μF/km)
U ₀ /U (kV)	U _m (kV)					In air (A)	Buried (A)				
Copper conductor											
6/10	12	25	15,0	27,5	1 050	166	163	3,6	0,7270	0,46	0,22
		35	16,0	28,5	1 175	201	196	5,0	0,5240	0,44	0,24
		50	17,0	29,5	1 325	240	231	7,2	0,3870	0,41	0,27
		70	18,5	31,5	1 575	299	282	10,0	0,2680	0,39	0,30
		95	20,5	33,0	1 865	364	338	13,6	0,1930	0,37	0,34
		120	22,0	35,0	2 170	420	383	17,2	0,1530	0,36	0,37
		150	23,0	36,0	2 445	474	428	21,5	0,1240	0,35	0,39
		185	24,5	37,5	2 845	539	471	26,5	0,0991	0,34	0,42
		240	27,0	40,0	3 445	636	555	34,3	0,0754	0,32	0,48
		300	30,0	43,0	4 130	731	625	42,9	0,0601	0,31	0,53
		400	33,0	46,0	5 105	846	708	57,2	0,0470	0,30	0,59
500	36,0	49,5	6 100	972	797	71,5	0,0366	0,29	0,65		
630	41,5	53,0	7 815	1110	892	90,1	0,0283	0,28	0,72		
8,7/15	17,5	25	17,0	29,5	1 155	168	163	3,6	0,7270	0,48	0,18
		35	18,0	30,5	1 285	203	195	5,0	0,5240	0,45	0,20
		50	19,0	32,0	1 440	243	231	7,2	0,3870	0,43	0,21
		70	21,0	33,5	1 690	302	282	10,0	0,2680	0,41	0,24
		95	22,5	35,5	2 010	366	337	13,6	0,1930	0,39	0,27
		120	24,5	37,0	2 300	423	383	17,2	0,1530	0,37	0,29
		150	25,5	38,5	2 600	477	428	21,5	0,1240	0,36	0,31
		185	26,5	39,5	2 985	541	480	26,5	0,0991	0,35	0,33
		240	29,5	42,5	3 615	640	555	34,3	0,0754	0,34	0,38
		300	32,0	45,5	4 315	736	626	42,9	0,0601	0,32	0,42
		400	35,0	48,5	5 300	850	709	57,2	0,0470	0,31	0,46
500	38,0	52,0	6 335	976	798	71,5	0,0366	0,30	0,51		
630	44,0	55,5	8 045	1115	894	90,1	0,0283	0,29	0,56		
12/20	24	35	20,0	32,5	1 390	204	195	5,0	0,5240	0,47	0,17
		50	21,0	34,0	1 565	244	231	7,2	0,3870	0,44	0,19
		70	23,0	35,5	1 825	304	282	10,0	0,2680	0,42	0,21
		95	24,5	37,5	2 150	368	337	13,6	0,1930	0,40	0,23
		120	26,5	39,5	2 445	425	383	17,2	0,1530	0,38	0,25
		150	27,5	40,5	2 750	479	427	21,5	0,1240	0,37	0,27
		185	28,5	42,0	3 140	544	479	26,5	0,0991	0,36	0,28
		240	31,5	45,0	3 780	643	555	34,3	0,0754	0,35	0,32
		300	34,0	47,5	4 490	739	626	42,9	0,0601	0,33	0,35
		400	37,0	51,0	5 515	853	709	57,2	0,0470	0,32	0,39
		500	40,0	54,5	6 535	979	799	71,5	0,0366	0,31	0,43
630	46,0	58,0	8 300	1119	896	90,1	0,0283	0,30	0,47		



We reserve the right to modify, at any time, without any obligation and without prior notice, the specifications and other technical data in this document, which must be confirmed when ordering.



Voltage		Conductor cross-section (mm ²)	Diameter over insulation (mm)	Approx. outer diameter (mm)	Approx. weight XHIO1AV (kg/km)	Current carrying capacity ⚡		Cond. max. short-circuit current, t=1s (kA)	Cond. DC resistance @ 20°C (Ω/km)	Inductance ⚡ (mH/km)	Capacitance (μF/km)
U ₀ / U (kV)	Um (kV)					In air (A)	Buried (A)				
Copper conductor											
18/30	36	50	26,0	39,0	1 890	248	230	7,2	0,3870	0,48	0,14
		70	28,0	41,0	2 180	307	281	10,0	0,2680	0,45	0,16
		95	29,5	43,0	2 500	372	335	13,6	0,1930	0,43	0,18
		120	31,5	44,5	2 835	429	382	17,2	0,1530	0,41	0,19
		150	32,5	46,0	3 125	484	426	21,5	0,1240	0,40	0,20
		185	33,5	47,5	3 550	549	479	26,5	0,0991	0,39	0,21
		240	36,5	50,5	4 245	648	555	34,3	0,0754	0,37	0,24
		300	39,0	53,5	4 985	744	627	42,9	0,0601	0,36	0,26
		400	42,0	56,5	6 040	858	710	57,2	0,0470	0,34	0,29
		500	45,0	59,5	7 060	985	801	71,5	0,0366	0,33	0,31
		630	51,0	63,5	8 875	1126	900	90,1	0,0283	0,32	0,34

Aluminium conductor constructions

Voltage		Conductor cross-section (mm ²)	Diameter over insulation (mm)	Approx. outer diameter (mm)	Approx. weight LXHIO1AV (kg/km)	Current carrying capacity ⚡		Cond. max. short-circuit current, t=1s (kA)	Cond. DC resistance @ 20°C (Ω/km)	Inductance ⚡ (mH/km)	Capacitance (μF/km)
U ₀ / U (kV)	Um (kV)					In air (A)	Buried (A)				
Aluminium conductor											
3,6/6	7,2	25	12,5	25,5	810	127	127	2,4	1,2000	0,44	0,27
		35	13,5	26,5	870	153	151	3,3	0,8680	0,42	0,30
		50	15,0	27,5	940	183	179	4,7	0,6410	0,40	0,33
		70	16,5	29,0	1 050	229	219	6,6	0,4430	0,38	0,38
		95	18,0	31,0	1 180	279	262	9,0	0,3200	0,36	0,42
		120	20,0	32,5	1 315	324	299	11,3	0,2530	0,34	0,47
		150	21,0	34,0	1 450	366	334	14,2	0,2060	0,33	0,51
		185	22,5	35,5	1 605	420	377	17,5	0,1640	0,32	0,55
		240	25,5	38,5	1 875	497	437	22,7	0,1250	0,32	0,60
		300	28,5	42,0	2 190	575	493	28,3	0,1000	0,31	0,63
		400	32,0	45,5	2 595	671	563	37,8	0,0778	0,30	0,66
		500	35,0	49,0	3 035	779	641	47,2	0,0605	0,29	0,69
630	40,0	54,0	3 690	915	732	59,5	0,0469	0,28	0,79		
6/10	12	25	14,5	27,5	900	129	127	2,4	1,2000	0,46	0,22
		35	15,5	28,5	965	155	151	3,3	0,8680	0,44	0,24
		50	17,0	29,5	1 035	185	179	4,7	0,6410	0,42	0,26
		70	18,5	31,0	1 155	232	219	6,6	0,4430	0,39	0,30
		95	20,0	33,0	1 290	282	262	9,0	0,3200	0,37	0,33
		120	22,0	34,5	1 445	326	298	11,3	0,2530	0,36	0,37
		150	23,0	36,0	1 565	369	333	14,2	0,2060	0,35	0,39
		185	24,5	37,5	1 745	423	377	17,5	0,1640	0,34	0,43
		240	27,0	40,0	1 980	498	436	22,7	0,1250	0,32	0,47
		300	30,0	43,0	2 275	576	493	28,3	0,1000	0,31	0,53

MEDIUM VOLTAGE CABLE

Voltage		Conductor cross-section (mm ²)	Diameter over insulation (mm)	Approx. outer diameter (mm)	Approx. weight LXHIOIAV (kg/km)	Current carrying capacity ⚡		Cond. max. short-circuit current, t=1s (kA)	Cond. DC resistance @ 20°C (Ω/km)	Inductance ⚡ (mH/km)	Capacitance (μF/km)
U ₀ / U (kV)	U _m (kV)					In air (A)	Buried (A)				
Aluminium conductor											
6/10	12	400	32,5	46,0	2 655	672	564	37,8	0,0778	0,30	0,59
		500	35,5	49,0	3 065	779	641	47,2	0,0605	0,29	0,65
		630	40,5	54,5	3 725	915	732	59,5	0,0469	0,28	0,75
8,7/15	17,5	25	17,0	29,5	1 005	130	127	2,4	1,2000	0,48	0,18
		35	18,0	30,5	1 075	157	151	3,3	0,8680	0,46	0,19
		50	19,0	31,5	1 150	187	179	4,7	0,6410	0,43	0,21
		70	20,5	33,5	1 270	234	219	6,6	0,4430	0,41	0,24
		95	22,5	35,0	1 430	284	261	9,0	0,3200	0,39	0,27
		120	24,0	37,0	1 575	329	298	11,3	0,2530	0,37	0,29
		150	25,5	38,5	1 720	372	333	14,2	0,2060	0,36	0,31
		185	27,0	40,0	1 885	425	376	17,5	0,1640	0,35	0,34
		240	29,0	42,5	2 150	501	435	22,7	0,1250	0,34	0,37
		300	32,0	45,5	2 455	579	493	28,3	0,1000	0,32	0,42
		400	35,0	48,5	2 850	674	563	37,8	0,0778	0,31	0,46
		500	38,0	52,0	3 300	790	641	47,2	0,0605	0,30	0,51
630	42,5	56,5	3 950	917	732	59,5	0,0469	0,29	0,58		
12/20	24	35	20,0	32,5	1 180	158	151	3,3	0,8680	0,47	0,17
		50	21,0	34,0	1 275	189	178	4,7	0,6410	0,45	0,18
		70	22,5	35,5	1 405	235	219	6,6	0,4430	0,42	0,21
		95	24,5	37,5	1 570	286	261	9,0	0,3200	0,40	0,23
		120	26,0	39,0	1 720	330	297	11,3	0,2530	0,38	0,25
		150	27,5	40,5	1 875	373	333	14,2	0,2060	0,37	0,27
		185	29,0	42,0	2 045	426	376	17,5	0,1640	0,36	0,29
		240	31,0	44,5	2 315	503	435	22,7	0,1250	0,35	0,32
		300	34,0	47,5	2 635	581	493	28,3	0,1000	0,33	0,35
		400	37,0	51,0	3 060	676	563	37,8	0,0778	0,32	0,39
		500	40,0	54,0	3 500	783	641	47,2	0,0605	0,31	0,43
		630	44,5	59,0	4 200	918	732	59,5	0,0469	0,30	0,49
18/30	36	50	26,0	39,0	1.595	191	178	4,7	0,641	0,48	0,14
		70	27,5	41,0	1.760	238	218	6,6	0,443	0,45	0,16
		95	29,5	42,5	1.920	288	260	9,0	0,320	0,43	0,17
		120	31,0	44,5	2.105	333	297	11,3	0,253	0,41	0,19
		150	32,5	46,0	2.250	376	332	14,2	0,206	0,40	0,20
		185	34,0	47,5	2.460	430	375	17,5	0,164	0,39	0,21
		240	36,0	50,0	2.780	506	435	22,7	0,125	0,37	0,24
		300	39,0	53,5	3.125	584	493	28,3	0,100	0,36	0,26
		400	42,0	56,5	3.585	679	563	37,8	0,0778	0,34	0,29
		500	45,0	59,5	4.020	786	642	47,2	0,0605	0,33	0,31
		630	49,5	64,5	4.765	920	734	59,5	0,0469	0,32	0,35

Current carrying capacity calculated considering the following conditions: Maximum conductor temperature = 90°C
 Cables in air: Ambient temperature = 30°C
 Cables directly buried: Ground temperature = 20°C • Depth of laying = 0,7m • Thermal resistivity of soil = 1,0K.m/W



We reserve the right to modify, at any time, without any obligation and without prior notice, the specifications and other technical data in this document, which must be confirmed when ordering.



MEDIUM VOLTAGE CABLE

APPLICATION

Cable for power distribution and power supply stations used in Utility and Industrial applications, for rated voltages up to 18/30kV. Suitable for fixed installations, indoor or outdoor, in open air on cable trays, or underground in ducts or directly buried.

CABLE DESIGNATION

Cu / XLPE / Cu Tape screen / PVC or PE: XHIV • XHIE

Cu / XLPE / Cu Wire screen / PVC or PE: XHIOV • XHIOE

Al / XLPE / Cu Tape screen / PVC or PE: LXHIV • LXHIE

Al / XLPE / Cu Wire screen / PVC or PE: LXHIOV • LXHIOE

CONSTRUCTION CHARACTERISTICS

Conductor

Plain annealed Copper or Aluminium, circular, stranded, class 2 per IEC 60228.

Insulation

Semi-conductive screen over the conductor, XLPE (cross-linked polyethylene) insulation and Semi-conductive screen over the insulation (strippable₁), applied by simultaneous extrusion in just one operation.

(1) Bonded upon agreement.

Metallic Screen over each conductor

Copper wire screen – annealed copper wires helically wound and an equalising copper tape applied in an open counter-helix.

Or Copper tape screen – a copper tape, standard thickness 0,1 mm helically applied with overlap.

Screened conductors are stranded together with fillers. A plastic tape is applied over this core.

Fillers

Extruded polymeric material.

Oversheath

Extruded PVC, type ST2 or PE type ST7.

Optionally, a Low Smoke Halogen Free thermoplastic compound can be used for cables with need for improved fire behaviour.

COLOUR AND CABLE MARKING

Black (other upon agreement). Oversheath marked at regular intervals with the following information: CABELTE <cable designation> 3 x <cond. cross-section>/<screen cross-section (if copper wires screen)> <rated voltage> <order of manufacture>/<year of manufacture> <metric marking>

GENERAL CHARACTERISTICS

Construction and test standards	IEC 60228 IEC 60502-2
Rated voltage U ₀ / U(Um)	3,6/6 (7,2) kV • 6/10 (12) kV • 8,7/15 (17,5) kV • 12/20 (24) kV • 18/30 (36) kV
Standard cross-section of wire screen	16 • 25 • 30 • 35
Test voltage	3,5 x U ₀
Conductor maximum operating temperature	90°C



We reserve the right to modify, at any time, without any obligation and without prior notice, the specifications and other technical data in this document, which must be confirmed when ordering.



Maximum short-circuit temperature	250°C (t ≤ 5s)
Minimum bending radius – during installation (mm)	20 x d
Minimum bending radius – after installation (mm)	15 x d
Maximum pulling force over conductor (N)	Copper – 50 x S Aluminium – 30 x S
Flame retardant (for PVC oversheath)	IEC 60332-1-2 • EN 60332-1-2 (cable vertically mounted, length of charred cable ≤ 540 mm).
Fire retardant (for PVC oversheath, upon agreement)	IEC 60332-3-24 • EN 60332-3-24 (bunch of cables vertically mounted on a ladder, length of charred cable ≤ 2,5 m)

S – conductor cross-section (mm²)

d – cable outer diameter (mm)

ELECTRICAL AND DIMENSIONAL CHARACTERISTICS

Copper conductor constructions

Voltage		Conductor cross-section	Diameter over insulation	Approx. outer diameter	Approx. weight XHIOV	Current carrying capacity		Cond. max. short-circuit current, t=1s	Cond. DC resistance @ 20°C	Inductance	Capacitance
U _o / U	U _m					In air	Buried				
(kV)	(kV)	(mm ²)	(mm)	(mm)	(kg/km)	(A)	(A)	(kA)	(Ω/km)	(mH/km)	(μF/km)
Copper conductor											
3,6/6	7,2	25	13,0	39,5	2 395	142	148	3,6	0,7270	0,38	0,27
		35	14,0	42,0	2 770	170	175	5,0	0,5240	0,36	0,30
		50	15,0	44,5	3 270	204	209	7,5	0,3870	0,34	0,33
		70	16,5	48,5	4 085	253	256	10,0	0,2680	0,32	0,38
		95	18,5	52,5	5 005	304	303	13,6	0,1930	0,30	0,43
		120	20,0	56,5	5 910	351	345	17,2	0,1530	0,29	0,48
		150	21,0	59,0	6 825	398	390	21,5	0,1240	0,28	0,51
		185	22,5	62,0	8 055	455	440	26,5	0,0991	0,28	0,54
		240	25,5	69,0	10 180	531	507	34,3	0,0754	0,27	0,60
		300	28,5	76,0	12 490	606	571	42,9	0,0601	0,26	0,63
400	32,0	84,0	15 820	696	645	57,2	0,0470	0,26	0,66		
6/10	12	25	15,0	44,0	2 715	142	148	3,6	0,7270	0,40	0,22
		35	16,0	46,5	3 115	170	175	5,0	0,5240	0,38	0,24
		50	17,0	49,0	3 640	204	209	7,5	0,3870	0,37	0,27
		70	18,5	53,0	4 480	253	256	10,0	0,2680	0,34	0,30
		95	20,5	57,0	5 460	304	303	13,6	0,1930	0,32	0,34
		120	22,0	61,0	6 395	351	345	17,2	0,1530	0,31	0,37
		150	23,0	63,5	7 335	398	390	21,5	0,1240	0,30	0,39
		185	24,5	66,5	8 590	455	440	26,5	0,0991	0,29	0,42
		240	27,0	72,5	10 605	531	507	34,3	0,0754	0,28	0,48
		300	30,0	79,0	12 880	606	571	42,9	0,0601	0,27	0,53
400	33,0	85,5	16 050	696	645	57,2	0,0470	0,26	0,59		

MEDIUM VOLTAGE CABLE

Voltage		Conductor cross-section (mm ²)	Diameter over insulation (mm)	Approx. outer diameter (mm)	Approx. weight XHIOV (kg/km)	Current carrying capacity ⚡		Cond. max. short-circuit current, t=1s (kA)	Cond. DC resistance @ 20°C (Ω/km)	Inductance ⚡ (mH/km)	Capacitance (μF/km)
U ₀ /U (kV)	U _m (kV)					In air (A)	Buried (A)				
Copper conductor											
8,7/15	17,5	25	17,0	49,0	3 125	142	148	3,6	0,7270	0,43	0,18
		35	18,0	51,5	3 540	170	175	5,0	0,5240	0,41	0,20
		50	19,0	54,5	4 135	204	209	7,5	0,3870	0,39	0,21
		70	21,0	58,0	4 965	253	256	10,0	0,2680	0,36	0,24
		95	22,5	62,0	5 950	304	303	13,6	0,1930	0,34	0,27
		120	24,5	66,0	6 915	351	345	17,2	0,1530	0,33	0,29
		150	25,5	68,5	7 940	398	390	21,5	0,1240	0,32	0,31
		185	26,5	71,5	9 160	455	440	26,5	0,0991	0,31	0,33
		240	29,5	78,0	11 265	531	507	34,3	0,0754	0,30	0,38
		300	32,0	84,0	13 595	606	571	42,9	0,0601	0,29	0,42
		400	35,0	90,5	16 825	696	645	57,2	0,0470	0,27	0,46
12/20	24	35	20,0	56,0	3 950	170	175	5,0	0,5240	0,43	0,17
		50	21,0	59,0	4 525	204	209	7,5	0,3870	0,41	0,19
		70	23,0	63,0	5 470	253	256	10,0	0,2680	0,37	0,21
		95	24,5	67,0	6 485	304	303	13,6	0,1930	0,36	0,23
		120	26,5	70,5	7 480	351	345	17,2	0,1530	0,34	0,25
		150	27,5	73,5	8 465	398	390	21,5	0,1240	0,33	0,27
		185	28,5	76,5	9 775	455	440	26,5	0,0991	0,32	0,28
		240	31,5	82,5	11 930	531	507	34,3	0,0754	0,31	0,32
		300	34,0	88,5	14 270	606	571	42,9	0,0601	0,30	0,35
		400	37,0	95,5	17 600	696	645	57,2	0,0470	0,29	0,39
18/30	36	50	26,0	70,5	5 800	204	209	7,5	0,3870	0,45	0,14
		70	28,0	74,5	6 795	253	256	10,0	0,2680	0,41	0,16
		95	29,5	78,5	7 985	304	303	13,6	0,1930	0,39	0,18
		120	31,5	82,5	9 060	351	345	17,2	0,1530	0,38	0,19
		150	32,5	85,0	10 030	398	390	21,5	0,1240	0,36	0,20
		185	33,5	88,0	11 475	455	440	26,5	0,0991	0,35	0,21
		240	36,5	94,0	13 630	531	507	34,3	0,0754	0,34	0,24
		300	39,0	100,0	16 145	606	571	42,9	0,0601	0,32	0,26
		400	42,0	107,0	19 650	696	645	57,2	0,0470	0,31	0,29

Current carrying capacity calculated considering the following conditions:

Maximum conductor temperature = 90°C

Cables in air: Ambient temperature = 30°C

Cables directly buried: Ground temperature = 20°C • Depth of laying = 0,7m • Thermal resistivity of soil = 1,0K.m/W

ELECTRICAL AND DIMENSIONAL CHARACTERISTICS

Aluminium conductor constructions

Voltage		Conductor cross-section (mm ²)	Diameter over insulation (mm)	Approx. outer diameter (mm)	Approx. weight LXHIOV (kg/km)	Current carrying capacity Σ		Cond. max. short-circuit current, t=1s (kA)	Cond. DC resistance @ 20°C (Ω/km)	Inductance Σ (mH/km)	Capacitance (μF/km)
U ₀ / U (kV)	U _m (kV)					In air (A)	Buried (A)				
Aluminium conductor											
3,6/6	7,2	25	12,5	39,0	1 935	142	115	2,4	1,2000	0,38	0,27
		35	13,5	41,5	2 140	170	136	3,3	0,8680	0,36	0,30
		50	15,0	44,0	2 395	204	162	4,7	0,6410	0,35	0,33
		70	16,5	48,0	2 785	253	198	6,6	0,4430	0,32	0,38
		95	18,0	52,0	3 270	304	235	9,0	0,3200	0,30	0,42
		120	20,0	56,0	3 725	351	268	11,3	0,2530	0,29	0,47
		150	21,0	59,0	4 170	398	303	14,2	0,2060	0,29	0,51
		185	22,5	62,5	4 725	455	343	17,5	0,1640	0,28	0,55
		240	25,5	68,5	5 750	531	397	22,7	0,1250	0,27	0,60
		300	28,5	76,0	6 860	606	448	28,3	0,1000	0,26	0,63
400	32,0	83,5	8 390	696	511	37,8	0,0778	0,26	0,66		
6/10	12	25	14,5	43,5	2 255	142	115	2,4	1,2000	0,40	0,22
		35	15,5	46,0	2 480	170	136	3,3	0,8680	0,39	0,24
		50	17,0	49,0	2 765	204	162	4,7	0,6410	0,37	0,26
		70	18,5	52,5	3 175	253	198	6,6	0,4430	0,34	0,30
		95	20,0	56,5	3 720	304	235	9,0	0,3200	0,32	0,33
		120	22,0	60,5	4 210	351	268	11,3	0,2530	0,31	0,37
		150	23,0	63,5	4 680	398	303	14,2	0,2060	0,30	0,39
		185	24,5	67,0	5 260	455	343	17,5	0,1640	0,29	0,43
		240	27,0	72,0	6 170	531	397	22,7	0,1250	0,28	0,47
		300	30,0	79,0	7 255	606	448	28,3	0,1000	0,27	0,53
400	32,5	85,5	8 620	696	511	37,8	0,0778	0,26	0,59		
8,7/15	17,5	25	17,0	49,0	2 665	142	115	2,4	1,2000	0,43	0,18
		35	18,0	51,5	2 905	170	136	3,3	0,8680	0,41	0,19
		50	19,0	54,0	3 210	204	162	4,7	0,6410	0,39	0,21
		70	20,5	58,0	3 650	253	198	6,6	0,4430	0,36	0,24
		95	22,5	61,5	4 210	304	235	9,0	0,3200	0,34	0,27
		120	24,0	65,5	4 725	351	268	11,3	0,2530	0,33	0,29
		150	25,5	68,5	5 285	398	303	14,2	0,2060	0,32	0,31
		185	27,0	72,0	5 835	455	343	17,5	0,1640	0,31	0,34
		240	29,0	77,5	6 830	531	397	22,7	0,1250	0,30	0,37
		300	32,0	84,0	7 965	606	448	28,3	0,1000	0,29	0,42
400	35,0	90,5	9 390	696	511	37,8	0,0778	0,27	0,46		

MEDIUM VOLTAGE CABLE

Voltage		Conductor cross-section (mm ²)	Diameter over insulation (mm)	Approx. outer diameter (mm)	Approx. weight LXHIOV (kg/km)	Current carrying capacity ⚡		Cond. max. short-circuit current, t=1s (kA)	Cond. DC resistance @ 20°C (Ω/km)	Inductance ⚡ (mH/km)	Capacitance (μF/km)
U _o / U (kV)	U _m (kV)					In air (A)	Buried (A)				
Aluminium conductor											
12/20	24	35	20,0	56,0	3 315	170	136	3,3	0,8680	0,43	0,17
		50	21,0	58,5	3 645	204	162	4,7	0,6410	0,41	0,18
		70	22,5	62,5	4 145	253	198	6,6	0,4430	0,38	0,21
		95	24,5	66,5	4 740	304	235	9,0	0,3200	0,36	0,23
		120	26,0	70,5	5 285	351	268	11,3	0,2530	0,34	0,25
		150	27,5	73,5	5 810	398	303	14,2	0,2060	0,33	0,27
		185	29,0	76,5	6 450	455	343	17,5	0,1640	0,32	0,29
		240	31,0	82,0	7 495	531	397	22,7	0,1250	0,31	0,32
		300	34,0	88,5	8 640	606	448	28,3	0,1000	0,30	0,35
		400	37,0	95,0	10 165	696	511	37,8	0,0778	0,29	0,39
18/30	36	50	26,0	70,0	4 915	204	162	4,7	0,6410	0,45	0,14
		70	27,5	74,0	5 520	253	198	6,6	0,4430	0,41	0,16
		95	29,5	78,0	6 170	304	235	9,0	0,3200	0,39	0,17
		120	31,0	82,0	6 865	351	268	11,3	0,2530	0,38	0,19
		150	32,5	85,0	7 375	398	303	14,2	0,2060	0,37	0,20
		185	34,0	88,5	8 160	455	343	17,5	0,1640	0,35	0,21
		240	36,0	93,5	9 190	531	397	22,7	0,1250	0,34	0,24
		300	39,0	100,0	10 515	606	448	28,3	0,1000	0,32	0,26
		400	42,0	106,5	12 115	696	511	37,8	0,0778	0,31	0,29

Current carrying capacity calculated considering the following conditions:

Maximum conductor temperature = 90°C

Cables in air: Ambient temperature = 30°C

Cables directly buried: Ground temperature = 20°C • Depth of laying = 0,7 m • Thermal resistivity of soil = 1,0 K.m/W

MEDIUM VOLTAGE CABLE

Unarmoured • XLPE Insulation • Collective Screen • BS 7870-4.20

APPLICATION

Cable for power distribution and power supply stations used in Utility and Industrial applications, for rated voltages 6,35/11kV. Suitable for fixed installations, indoor or outdoor, in open air on cable trays, or underground in ducts or directly buried. Non radial field cable.

CABLE DESIGNATION

Al / XLPE / Cu Wire screen / PE: LSXHOE

CONSTRUCTION CHARACTERISTICS

Conductor

Solid aluminium conductor, circular, class 1 per BS EN 60228.

Insulation

Semi-conductive screen over the conductor, XLPE (cross-linked polyethylene) insulation and semi-conductive screen over the insulation (strippable or bonded), applied by simultaneous extrusion in just one operation.

Fillers

Extruded polymeric material.

Collective Metallic Screen

Applied over a semi-conductive tape firmly holding the three cores and fillers. Composed by annealed copper wires helically wound. An equalising copper tape is applied in an open counter-helix. Plastic tape is applied over the metallic screen.

Oversheath

Extruded MDPE.

Optionally, a Low Smoke Halogen Free thermoplastic compound can be used for cables with need for improved fire behaviour.

COLOUR AND CABLE MARKING

Red. Oversheath marked at regular intervals with the following information:

ELECTRIC CABLE 11000V BS7870-4.20 CABELTE 3 x <cond. cross-section> AL <year of manufacture> <metric marking>

GENERAL CHARACTERISTICS

Construction and test standards	BS EN 60228 • BS 7870-4.20
Rated voltage U_0 / $U(U_m)$	6,35/11 (12) kV
Standard cross-section of wire screen	35 • 50 • 70 • 95
Test voltage	4 x U_0
Conductor maximum operating temperature	90°C
Maximum short-circuit temperature	250°C ($t \leq 5s$)
Minimum bending radius – during installation (mm)	20 x d
Minimum bending radius – after installation (mm)	15 x d
Maximum pulling force over conductor (N)	30 x S

S – conductor cross-section (mm²) • μd – cable outer diameter (mm)



We reserve the right to modify, at any time, without any obligation and without prior notice, the specifications and other technical data in this document, which must be confirmed when ordering.



MEDIUM VOLTAGE CABLE

APPLICATION

Cable for power distribution and power supply stations used in Utility and Industrial applications, for rated voltages up to 18/30kV. Suitable for fixed installations, directly buried. Good mechanical protection.

CABLE DESIGNATION

Cu / XLPE / Cu Tape screen / Steel Tape armour / PVC or PE: XHIAV • XHIAE
 Cu / XLPE / Cu Wire screen / Steel Tape armour / PVC or PE: XHIOAV • XHIOAE
 Al / XLPE / Cu Tape screen / Steel Tape armour / PVC or PE: LXHIAV • LXHIAE
 Al / XLPE / Cu Wire screen / Steel Tape armour / PVC or PE: LXHIOAV • LXHIOAE
 Cu / XLPE / Cu Tape screen / Galv. Steel Wire armour / PVC or PE: XHIRV • XHIRE
 Cu / XLPE / Cu Wire screen / Galv. Steel Wire armour / PVC or PE: XHIORV • XHIORE
 Al / XLPE / Cu Tape screen / Galv. Steel Wire armour / PVC or PE: LXHIRV • LXHIRE
 Al / XLPE / Cu Wire screen / Galv. Steel Wire armour / PVC or PE: LXHIORV • LXHIORE

CONSTRUCTION CHARACTERISTICS

Conductor

Plain annealed Copper or Aluminium, circular, stranded, class 2 per IEC 60228.

Insulation

Semi-conductive screen over the conductor, XLPE (cross-linked polyethylene) insulation and Semi-conductive screen over the insulation (strippable¹), applied by simultaneous extrusion in just one operation.

(1) Bonded upon agreement.

Metallic Screen

Copper wire screen – annealed copper wires helically wound and an equalising copper tape applied in an open counter-helix. Plastic tape is applied over the screen.

Or Copper tape screen – a copper tape, standard thickness 0,1 mm helically applied with overlap.

Fillers

Extruded polymeric material.

Inner Sheath

Extruded PVC or PE.

Armour

Steel double tape, helically applied.

Or Galvanized steel wires, helically applied, tightened with plastic tapes.

Oversheath

Extruded PVC, type ST2 or PE type ST7.

Optionally, a Low Smoke Halogen Free thermoplastic compound can be used for cables with need for improved fire behaviour.

COLOUR AND CABLE MARKING

Black (other upon agreement).

Oversheath marked at regular intervals with the following information:

CABELTE <cable designation> 3 x <cond. cross-section>/<screen cross-section (if copper wires screen)> <rated voltage> <order of manufacture>/<year of manufacture> <metric marking>



GENERAL CHARACTERISTICS

Construction and test standards	IEC 60228 IEC 60502-2
Rated voltage $U_0/ U(U_m)$	3,6/6 (7,2) kV • 6/10 (12) kV • 8,7/15 (17,5) kV • 12/20 (24) kV • 18/30 (36) kV
Standard cross-section of wire screen	16 • 25 • 30 • 35
Test voltage	3,5 x U_0
Conductor maximum operating temperature	90°C
Maximum short-circuit temperature	250°C (t ≤ 5s)
Minimum bending radius – during installation (mm)	15 x d
Minimum bending radius – after installation (mm)	10 x d
Maximum pulling force over conductor (N)	Copper – 50 x S Aluminium – 30 x S
Flame retardant (for PVC oversheath)	IEC 60332-1-2 • EN 60332-1-2 (cable vertically mounted, length of charred cable ≤ 540 mm).
Fire retardant (for PVC oversheath, upon agreement)	IEC 60332-3-24 • EN 60332-3-24 (bunch of cables vertically mounted on a ladder, length of charred cable ≤ 2,5 m)



S – conductor cross-section (mm²)
d – cable outer diameter (mm)

ELECTRICAL AND DIMENSIONAL CHARACTERISTICS

Copper conductor constructions

Voltage		Conductor cross-section (mm ²)	Diameter over insulation (mm)	Approx. outer diameter (mm)	Approx. weight XHIOAV (kg/km)	Current carrying capacity I_{sc}		Cond. max. short-circuit current, t=1s (kA)	Cond. DC resistance @ 20°C (Ω/km)	Inductance L (mH/km)	Capacitance (μF/km)
U_0/ U (kV)	U_m (kV)					In air (A)	Buried (A)				
Copper conductor											
3,6/6	7,2	25	13,0	44,5	3 320	143	148	3,6	0,7270	0,38	0,27
		35	14,0	47,0	3 775	172	177	5,0	0,5240	0,36	0,30
		50	15,0	49,5	4 340	205	209	7,5	0,3870	0,34	0,33
		70	16,5	54,0	5 280	253	255	10,0	0,2680	0,32	0,38
		95	18,5	58,0	6 325	307	304	13,6	0,1930	0,30	0,43
		120	20,0	61,5	7 290	352	345	17,2	0,1530	0,29	0,48
		150	21,0	64,5	8 300	397	388	21,5	0,1240	0,28	0,51
		185	22,5	67,5	9 640	453	437	26,5	0,0991	0,28	0,54
		240	25,5	75,0	11 985	529	503	34,3	0,0754	0,27	0,60
		300	28,5	82,0	14 475	599	563	42,9	0,0601	0,26	0,63
*400	32,0	91,5	18 920	683	631	57,2	0,0470	0,26	0,66		

Aluminium conductor constructions

Voltage		Conductor cross-section (mm ²)	Diameter over insulation (mm)	Approx. outer diameter (mm)	Approx. weight LXHIO1AV (kg/km)	Current carrying capacity 		Cond. max. short-circuit current, t=1s (kA)	Cond. DC resistance @ 20°C (Ω/km)	Inductance  (mH/km)	Capacitance (μF/km)
U ₀ / U (kV)	U _m (kV)					In air (A)	Buried (A)				
Aluminium conductor											
3,6/6	7,2	25	12,5	44,0	2 860	111	115	2,4	1,2000	0,38	0,27
		35	13,5	46,5	3 140	133	136	3,3	0,8680	0,36	0,30
		50	15,0	49,5	3 460	159	162	4,7	0,6410	0,35	0,33
		70	16,5	53,5	3 965	196	198	6,6	0,4430	0,32	0,38
		95	18,0	57,5	4 575	238	236	9,0	0,3200	0,30	0,42
		120	20,0	61,0	5 095	274	268	11,3	0,2530	0,29	0,47
		150	21,0	64,5	5 650	309	302	14,2	0,2060	0,29	0,51
		185	22,5	68,0	6 320	354	342	17,5	0,1640	0,28	0,55
		240	25,5	74,5	7 545	415	395	22,7	0,1250	0,27	0,60
		300	28,5	82,0	8 845	472	444	28,3	0,1000	0,26	0,63
*400	32,0	91,0	11 485	545	504	37,8	0,0778	0,26	0,66		
6/10	12	25	14,5	49,0	3 310	111	115	2,4	1,2000	0,40	0,22
		35	15,5	51,5	3 620	133	136	3,3	0,8680	0,39	0,24
		50	17,0	54,0	3 965	159	162	4,7	0,6410	0,37	0,26
		70	18,5	58,0	4 500	196	198	6,6	0,4430	0,34	0,30
		95	20,0	62,0	5 075	238	236	9,0	0,3200	0,32	0,33
		120	22,0	66,0	5 690	274	268	11,3	0,2530	0,31	0,37
		150	23,0	69,5	6 305	309	302	14,2	0,2060	0,30	0,39
		185	24,5	72,5	6 975	354	342	17,5	0,1640	0,29	0,43
		240	27,0	78,0	8 015	415	395	22,7	0,1250	0,28	0,47
		300	30,0	85,0	9 305	472	444	28,3	0,1000	0,27	0,53
*400	32,5	93,0	11 775	545	504	37,8	0,0778	0,26	0,59		
8,7/15	17,5	25	17,0	54,5	3 870	111	115	2,4	1,2000	0,43	0,18
		35	18,0	57,0	4 200	133	136	3,3	0,8680	0,41	0,19
		50	19,0	59,0	4 530	159	162	4,7	0,6410	0,39	0,21
		70	20,5	63,5	5 100	196	198	6,6	0,4430	0,36	0,24
		95	22,5	67,0	5 750	238	236	9,0	0,3200	0,34	0,27
		120	24,0	71,5	6 405	274	268	11,3	0,2530	0,33	0,29
		150	25,5	74,5	7 075	309	302	14,2	0,2060	0,32	0,31
		185	27,0	77,5	7 670	354	342	17,5	0,1640	0,31	0,34
		240	29,0	83,5	8 845	415	395	22,7	0,1250	0,30	0,37
		*300	32,0	91,5	11 075	472	444	28,3	0,1000	0,29	0,42
*400	35,0	98,5	12 785	545	504	37,8	0,0778	0,27	0,46		

MEDIUM VOLTAGE CABLE

Voltage		Conductor cross-section (mm ²)	Diameter over insulation (mm)	Approx. outer diameter (mm)	Approx. weight LXHIOIAV (kg/km)	Current carrying capacity ⚡		Cond. max. short-circuit current, t=1s (kA)	Cond. DC resistance @ 20°C (Ω/km)	Inductance ⚡ (mH/km)	Capacitance (μF/km)
U _o / U (kV)	U _m (kV)					In air (A)	Buried (A)				
Aluminium conductor											
12/20	24	35	20,0	61,0	4 685	133	136	3,3	0,8680	0,43	0,17
		50	21,0	64,0	5 110	159	162	4,7	0,6410	0,41	0,18
		70	22,5	68,0	5 710	196	198	6,6	0,4430	0,38	0,21
		95	24,5	72,0	6 435	238	236	9,0	0,3200	0,36	0,23
		120	26,0	76,0	7 080	274	268	11,3	0,2530	0,34	0,25
		150	27,5	79,0	7 680	309	302	14,2	0,2060	0,33	0,27
		185	29,0	82,5	8 445	354	342	17,5	0,1640	0,32	0,29
		*240	31,0	89,5	10 535	415	395	22,7	0,1250	0,31	0,32
		*300	34,0	96,5	11 970	472	444	28,3	0,1000	0,30	0,35
*400	37,0	103,0	13 730	545	504	37,8	0,0778	0,29	0,39		
18/30	36	50	26,0	76,0	6 700	159	162	4,7	0,6410	0,45	0,14
		70	27,5	80,0	7 445	196	198	6,6	0,4430	0,41	0,16
		95	29,5	85,5	9 015	238	236	9,0	0,3200	0,39	0,17
		120	31,0	89,5	9 895	274	268	11,3	0,2530	0,38	0,19
		*150	32,5	92,5	10 515	309	302	14,2	0,2060	0,37	0,20
		*185	34,0	96,0	11 420	354	342	17,5	0,1640	0,35	0,21
		*240	36,0	101,5	12 750	415	395	22,7	0,1250	0,34	0,24
		*300	39,0	108,0	14 320	472	444	28,3	0,1000	0,32	0,26
*400	42,0	115,0	16 220	545	504	37,8	0,0778	0,31	0,29		

*Only for steel tape armoured cables.

Current carrying capacity calculated considering the following conditions: Maximum conductor temperature = 90°C

Cables in air: Ambient temperature = 30°C

Cables directly buried: Ground temperature = 20°C • Depth of laying = 0,7m • Thermal resistivity of soil = 1,0K.m/W

MEDIUM VOLTAGE CABLE

APPLICATION

Three single-core cables pre-assembled without messenger, for power distribution and power supply stations used in Utility and Industrial applications, for rated voltages up to 18/30kV. Suitable for fixed installations, indoor or outdoor, in open air on cable trays, or underground in ducts or directly buried.

CABLE DESIGNATION

Cu / XLPE / Cu Tape screen / PVC or PE XHIV • XHIE
 Cu / XLPE / Cu Wire screen / PVC or PE XHIOV • XHIOE
 Al / XLPE / Cu Tape screen / PVC or PE LXHIV • LXHIE
 Al / XLPE / Cu Wire screen / PVC or PE LXHIOV • LXHIOE
 Watertight constructions XHIOE(be) or XHIOE(cbe)
 LXHIOE(be) or LXHIOE(cbe)

CONSTRUCTION CHARACTERISTICS

Conductor

Plain annealed Copper or Aluminium, circular, stranded, class 2 per IEC 60228.

Insulation

Semi-conductive screen over the conductor, XLPE (cross-linked polyethylene) insulation and Semi-conductive screen over the insulation (strippable₁), applied by simultaneous extrusion in just one operation.

(1) Bonded upon agreement.

Metallic Screen

Copper wire screen – annealed copper wires helically wound and an equalising copper tape applied in an open counter-helix.

Plastic tape is applied over the screen.

Or Copper tape screen – a copper tape, standard thickness 0,1 mm helically applied with overlap.

Oversheath

Extruded PVC type ST2 or DMV30, or PE type ST7 or DMP15.

Watertightness option

(be) – Metallic screen longitudinally watertight. Assured by application of a waterblocking tape over the metallic screen. A waterblocking yarn under the screen may be considered.

(cbe) – Conductor and metallic screen longitudinally watertight. Conductor: assured by water-blocking yarns and/or tapes between wire layers; Metallic screen: assured by application of a water-blocking tape over metallic screen. A waterblocking yarn under the screen may be considered.

COLOUR AND CABLE MARKING

Black (other upon agreement).

Oversheath marked at regular intervals with the following information:

CABELTE <cable designation> 3 x <cond. cross-section>/<screen cross-section (if copper wires screen)> <rated voltage> <order of manufacture>/<year of manufacture> <metric marking>



GENERAL CHARACTERISTICS

Construction and test standards	IEC 60228 IEC 60502-2 • HD 620 S2
Rated voltage $U_0/ U(U_m)$	3,6/6 (7,2) kV • 6/10 (12) kV • 8,7/15 (17,5) kV • 12/20 (24) kV • 18/30 (36) kV
Standard cross-section of wire screen	16 • 25 • 30 • 35
Test voltage	3,5 x U_0
Conductor maximum operating temperature	90°C
Maximum short-circuit temperature	250°C (t ≤ 5s)
Minimum bending radius – during installation (mm)	12 x D
Minimum bending radius – after installation (mm)	9xD
Maximum pulling force over conductor (N)	Copper – 50 x S Aluminium – 30 x S
Flame retardant (for PVC oversheath)	IEC 60332-1-2 • EN 60332-1-2 (cable vertically mounted, length of charred cable ≤ 540 mm).

S – conductor cross-section (mm²)

D – diameter over the three cores aprox. 2,16 x d

d – single core cable outer diameter (mm)

MEDIUM VOLTAGE CABLE

APPLICATION

Three single-core cables pre-assembled with steel messenger, for power distribution and power supply stations used in Utility and Industrial applications, for rated voltages up to 18/30kV. Suitable for aerial installations.

CABLE DESIGNATION

Al / XLPE / Cu Tape screen / PVC or PE + Messenger LXHIVS • LXHIES

Al / XLPE / Cu Wire screen / PVC or PE + Messenger LXHIOVS • LXHIOES

Watertight constructions LXHIOES(be) or LXHIOES(cbe)

CONSTRUCTION CHARACTERISTICS

Conductor

Aluminium conductor, circular, stranded, class 2 per IEC 60288.

Insulation

Semi-conductive screen over the conductor, XLPE (cross-linked polyethylene) insulation and Semi-conductive screen over the insulation (strippable¹), applied by simultaneous extrusion in just one operation.

(1) Bonded upon agreement.

Metallic Screen

Copper wire screen – annealed copper wires helically wound and an equalising copper tape applied in an open counter-helix. Cross-section area of screen according to client request.

A wrapping plastic tape is applied over the screen.

Or Copper tape screen – a copper tape, standard thickness 0,1 mm helically applied with overlap.

Oversheath

Extruded PVC type ST2 or DMV30, or PE type ST7 or DMP15.

Watertightness option

(be) – Metallic screen longitudinally watertight. Assured by application of a waterblocking tape over the metallic screen. A waterblocking yarn under the screen may be considered.

(cbe) – Conductor and metallic screen longitudinally watertight. Conductor: Assured by waterblocking yarns and/or tapes between wire layers; Metallic screen: Assured by application of a waterblocking tape over metallic screen. A waterblocking yarn under the screen may be considered.

COLOUR AND CABLE MARKING

Black (other upon agreement).

Oversheath marked at regular intervals with the following information:

CABELTE <cable designation> 3 x <cond. cross-section>/<screen cross-section (if copper wires screen)> <rated voltage> <order of manufacture>/<year of manufacture> <metric marking>



HIGH VOLTAGE CABLE

APPLICATION

Cable for power distribution and power supply stations used in Utility and Industrial applications, for rated voltages 26/45kV and 36/60kV. Suitable for fixed installations, underground in ducts or directly buried.

CABLE DESIGNATION

Cu / XLPE / Cu Screen / Al Tape / PE: XHIOLE(cbe)

Al / XLPE / Cu Screen / Al Tape / PE: LXHIOLE(cbe)

CONSTRUCTION CHARACTERISTICS

Conductor

Plain annealed Copper or Aluminium, circular, stranded, class 2 per IEC 60228.

Insulation

Semi-conductive screen over the conductor, XLPE (cross-linked polyethylene) insulation and Semi-conductive screen over the insulation (adhered), applied by simultaneous extrusion in just one operation.

Metallic Screen

Annealed copper wires, helically wound and an equalising copper tape applied in an open counter-helix. Cross-section area of screen according to client request.

Oversheath

Aluminium copolymer coated tape, longitudinally applied, bonded to the extruded PE oversheath, type ST7.

Upon agreement, an extruded semi-conductive thin layer may be applied on the surface of the oversheath, to facilitate the detection and location of defective points.

Watertightness option

(cbe) – Conductor and metallic screen longitudinally watertight. Conductor: Use of waterblocking yarns and/or tapes between wire layers; Metallic screen: Assured by application of semi-conductive waterblocking tapes under and over the screen.

L – Radial watertightness provided by the aluminium-coated tape.

COLOUR AND CABLE MARKING

Black (other upon agreement). Oversheath marked at regular intervals with the following information:

CABELTE < cable designation > 3 x < cond. cross-section > / < screen cross-section (if copper wires screen) > < rated voltage > < order of manufacture > / < year of manufacture > < metric marking >

GENERAL CHARACTERISTICS

Construction and test standards	IEC 60228 • IEC 60840
Rated voltage U ₀ / U(U _m)	26/45 (52) kV – 36/60 (72,5) kV
Test voltage	2,5 x U ₀
Conductor maximum operating temperature	90°C
Maximum short-circuit temperature	250°C (t ≤ 5s)



GENERAL CHARACTERISTICS

Minimum bending radius – during installation (mm) 30 x d



Minimum bending radius – after installation (mm) 15 x d

Maximum pulling force over conductor (N) Copper – 50 x S
Aluminium – 30 x S



d – cable outer diameter (mm) • S – conductor cross-section (mm²)

ELECTRICAL AND DIMENSIONAL CHARACTERISTICS

Copper conductor constructions

Voltage		Conductor cross-section (mm ²)	Diameter over insulation (mm)	Approx. outer diameter (mm)	Approx. weight (kg/km)	Current carrying capacity 		Cond. max. short-circuit current, t=1s (kA)	Cond. DC resistance @ 20°C (Ω/km)	Inductance  (mH/km)	Capacitance (μF/km)
U ₀ / U (kV)	Um (kV)					In air (A)	Buried (A)				
36/60	72,5	185	43,5	60,0	4.980	526	407	26,5	0,0991	0,46	0,15
		400	51,6	68,0	7.250	795	578	57,2	0,0470	0,40	0,20
		630	60,6	77,0	9.970	1015	710	90,1	0,0283	0,37	0,25

Aluminium conductor constructions

Voltage		Conductor cross-section (mm ²)	Diameter over insulation (mm)	Approx. outer diameter (mm)	Approx. weight (kg/km)	Current carrying capacity 		Cond. max. short-circuit current, t=1s (kA)	Cond. DC resistance @ 20°C (Ω/km)	Inductance  (mH/km)	Capacitance (μF/km)
U ₀ / U (kV)	Um (kV)					In air (A)	Buried (A)				
36/60	72,5	185	43,5	60,0	3.900	415	322	17,5	0,164	0,46	0,15
		400	51,5	68,0	4.840	637	467	37,8	0,0778	0,40	0,20
		630	60,5	77,0	6.090	857	597	59,5	0,0469	0,37	0,25
		1000	69,0	86,0	7.620	1082	724	94,5	0,0291	0,34	0,29

Current carrying capacity calculated considering the following conditions:

- Maximum conductor temperature = 90°C
- Cables in air: Ambient temperature = 30°C
- Cables directly buried: Ground temperature = 20°C • Depth of laying = 1,3 m • Thermal resistivity of soil = 1,2K.m/W

BARE CONDUCTORS FOR AERIAL POWER LINES

- AAC – All aluminium conductor
- AAAC – All aluminium alloy conductor
- ACSR – Aluminium conductor steel reinforced
- AACSR – Aluminium alloy conductor steel reinforced
- ACSR/AW – Aluminium alloy conductor Aluminium clad steel reinforced
- ACAR – Aluminium conductor Aluminium alloy reinforced

Optical Power Ground Wire

- OPGW – stainless steel tube
- OPGW – aluminium tube

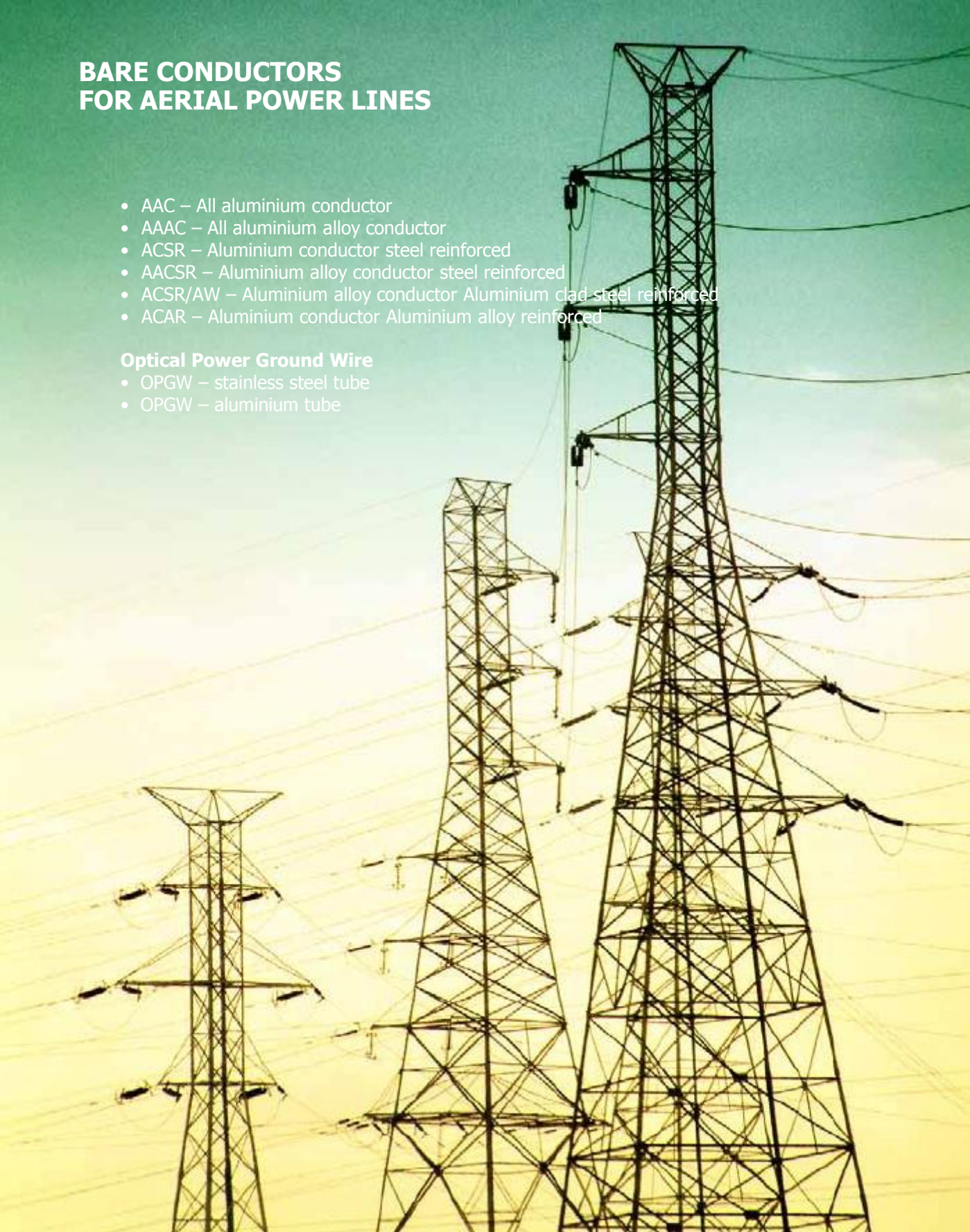

APPLICATION

Conductors used in short distance overhead distribution in high voltage power substations. Also used as covered conductors for low and medium voltage, suitable for be insulated or covered.

CONSTRUCTION CHARACTERISTICS

Conductors are formed by (hard drawn) aluminium bare wires concentrically stranded in layers. All wires have the same nominal diameter. For covered conductors the bare conductors can be compacted in order to reduce the amount of insulation material.

AAC – “All Aluminium Conductor”.

GENERAL CHARACTERISTICS

Aluminium with a conductivity of 61% IACS

Good electrical features

Good resistance to corrosion

Easy to compress

ELECTRICAL AND DIMENSIONAL CHARACTERISTICS

CENELEC EN50182:2001 standard

Characteristics of aluminium conductors – Type AL 1 – Spain

Code	Old code	Conductor area (mm ²)	N.º of wires	Wire diameter (mm)	Nominal diameter (mm)	Linear mass (kg/km)	Rated strength (kN)	Electrical resist. dc. 20°C (Ω/km)
28-AL1	L 28	27,8	7	2,25	6,75	76,1	5,01	1,0268
43-AL1	L 40	43,1	7	2,80	8,40	117,8	7,33	0,6630
55-AL1	L 56	54,6	7	3,15	9,45	149,1	9,00	0,5239
76-AL1	L 80	75,5	19	2,25	11,3	207,6	13,60	0,3804
117-AL1	L 110	117,0	19	2,80	14,0	321,5	19,89	0,2456
148-AL1	L 145	148,1	19	3,15	15,8	407,0	24,43	0,1941
188-AL1	L 180	188,1	19	3,55	17,8	516,9	30,09	0,1528
279-AL1	L 280	279,3	37	3,10	21,7	770,2	46,08	0,1033
381-AL1	L 400	381,0	61	2,82	25,4	1 054,1	64,77	0,0759
454-AL1	L 450	454,5	61	3,08	27,7	1 257,5	74,99	0,0637
547-AL1	L 550	547,3	61	3,38	30,4	1 514,4	90,31	0,0529
638-AL1	L 630	638,3	61	3,65	32,9	1 766,0	102,12	0,0453

Note 1 – Outer layer stranding direction: Right-hand (Z).



CENELEC EN50182:2001 standard

Characteristics of aluminium conductors – Type AL 1 – Germany

Code	Old code	Conductor area (mm ²)	N. ^o of wires	Wire diameter (mm)	Nominal diameter (mm)	Linear mass (Kg/km)	Rated strength (kN)	Electrical resist. d.c. 20°C (Ω/km)	Final modulus of elasticity (N/mm ²)	Final coefficient of linear expansion (1/K)	Current carrying capacity A (1)
16-AL1	16	15,9	7	1,70	5,10	43,4	3,02	1,798 6	60 000	2,30E-05	110
24-AL1	25	24,2	7	2,10	6,30	66,3	4,36	1,178 7	60 000	2,30E-05	145
34-AL1	35	34,4	7	2,50	7,50	93,9	6,01	0,831 7	60 000	2,30E-05	180
49-AL1	50	49,5	7	3,00	9,00	135,2	8,41	0,577 6	60 000	2,30E-05	225
48-AL1	50	48,3	19	1,80	9,00	132,9	8,94	0,594 4	57 000	2,30E-05	225
66-AL1	70	65,8	19	2,10	10,5	180,9	11,85	0,436 7	57 000	2,30E-05	270
93-AL1	95	93,3	19	2,50	12,5	256,3	16,32	0,308 1	57 000	2,30E-05	340
117-AL1	120	117,0	19	2,80	14,0	321,5	19,89	0,245 6	57 000	2,30E-05	390
147-AL1	150	147,1	37	2,25	15,8	405,7	26,48	0,196 0	57 000	2,30E-05	455
182-AL1	185	181,6	37	2,50	17,5	500,9	31,78	0,158 8	57 000	2,30E-05	520
243-AL1	240	242,5	61	2,25	20,3	671,1	43,66	0,119 3	55 000	2,30E-05	625
299-AL1	300	299,4	61	2,50	22,5	828,5	52,40	0,096 6	55 000	2,30E-05	710
400-AL1	400	400,1	61	2,89	26,0	1 107,1	68,02	0,072 3	55 000	2,30E-05	855
500-AL1	500	499,8	61	3,23	29,1	1 382,9	82,47	0,057 9	55 000	2,30E-05	990
626-AL1	625	626,2	91	2,96	32,6	1 739,7	106,45	0,046 4	55 000	2,30E-05	1 140
802-AL1	800	802,1	91	3,35	36,9	2 228,3	132,34	0,036 2	55 000	2,30E-05	1 340
1000-AL1	1 000	999,7	91	3,74	41,1	2 777,3	159,95	0,029 1	55 000	2,30E-05	1 540

Note 1 – (1) Guideline values of current carrying capacity are valid up to a frequency of 60 Hz, assuming a wind velocity of 0,6 m/s, the effect of solar radiation for Germany, an initial ambient temperature of 35° C and a conductor temperature of 80° C. For special applications, when there is no air turbulence, the values should be reduced by 30 %.

Note 2 – Values of final modulus of elasticity and coefficient of linear expansion for the conductor sizes listed in the Table are used in Germany. Values for other conductor constructions may be calculated using the method given in IEC 61597.

Note 3 – Outer layer stranding direction: Right-hand (Z).

CENELEC EN50182:2001 standard

Characteristics of aluminium conductors – Type AL 1 – United Kingdom

Code	Code word	Conductor area (mm ²)	N.º of wires	Wire diameter (mm)	Nominal diameter (mm)	Linear mass (kg/km)	Rated strength (kN)	Electrical resist. d.c. 20°C (Ω/km)
23-AL1	MIDGE	23,3	7	2,06	6,18	63,8	4,20	1,2249
27-AL1	GNAT	26,9	7	2,21	6,63	73,4	4,83	1,0643
37-AL1	MOSQUITO	36,9	7	2,59	7,77	100,8	6,27	0,7749
43-AL1	LADYBIRD	42,8	7	2,79	8,37	117,0	7,28	0,6678
53-AL1	ANT	52,8	7	3,10	9,30	144,4	8,72	0,5409
64-AL1	FLY	63,6	7	3,40	10,2	173,7	10,49	0,4497
74-AL1	BLUEBOTTLE	73,6	7	3,66	11,0	201,3	11,78	0,3880
79-AL1	EARWIG	78,6	7	3,78	11,3	214,7	12,57	0,3638
84-AL1	GRASSHOPPER	84,1	7	3,91	11,7	229,7	13,45	0,3400
96-AL1	CLEGG	95,6	7	4,17	12,5	261,3	15,30	0,2989
106-AL1	WASP	106,0	7	4,39	13,2	289,6	16,95	0,2697
106-AL1	BEETLE	106,4	19	2,67	13,4	292,4	18,08	0,2701
132-AL1	BEE	132,0	7	4,90	14,7	360,8	21,12	0,2165
158-AL1	HORNET	157,6	19	3,25	16,3	433,2	26,01	0,1823
186-AL1	CATERPILLAR	185,9	19	3,53	17,7	511,1	29,75	0,1546
213-AL1	CHAFER	213,2	19	3,78	18,9	586,0	34,12	0,1348
238-AL1	SPIDER	237,6	19	3,99	20,0	652,9	38,01	0,1210
266-AL1	COCKROACH	265,7	19	4,22	21,1	730,4	42,52	0,1081
323-AL1	BUTTERFLY	322,7	19	4,65	23,3	886,8	51,63	0,0891
373-AL1	MOTH	373,1	19	5,00	25,0	1 025,3	59,69	0,0770
372-AL1	DRONE	372,4	37	3,58	25,1	1 027,1	59,69	0,0774
415-AL1	CENTIPEDE	415,2	37	3,78	26,5	1 145,1	66,43	0,0695
486-AL1	MAYBUG	486,1	37	4,09	28,6	1 340,6	77,78	0,0593
530-AL1	SCORPION	529,8	37	4,27	29,9	1 461,2	84,77	0,0544
628-AL1	CICADA	628,3	37	4,65	32,6	1 732,9	100,54	0,0459

Note 1 – Outer layer stranding direction: Right-hand (Z).

ASTM B-231 standard

Characteristics of aluminium conductors – Countries with North American influence

Code word	Size (AWG)	Class	Composition	Conductor area (mm ²)	Outer diameter (mm)	Linear mass (Kg/km)	Rated strength (kN)	Electrical resist. d.c. 20°C (Ω/km)	Electrical resist. a.c. 25°C (Ω/km)	Electrical resist. a.c. 75°C (Ω/km)	Current carrying capacity A (I)
PEACHBELL	6	A	7 x 1,56	13,21	4,65	36,6	2,500	2,1702	2,2129	2,6499	110
ROSE	4	A	7 x 1,96	21,12	5,88	58,3	3,290	1,3638	1,3914	1,6663	145
IRIS	2	A,AA	7 x 2,47	33,54	7,41	92,7	6,010	0,8570	0,8750	1,0486	195
PANSY	1	A,AA	7 x 2,78	42,49	8,34	116,8	7,300	0,6801	0,6942	0,8310	225
POPPY	1/0	A,AA	7 x 3,12	53,52	9,36	147,5	8,860	0,5390	0,5499	0,6588	260
ASTER	2/0	A,AA	7 x 3,50	67,34	10,50	185,9	11,170	0,4275	0,4374	0,5226	305
PHLOX	3/0	A,AA	7 x 3,93	84,91	11,79	234,4	13,530	0,3392	0,3468	0,4150	350
OXLIP	4/0	A,AA	7 x 4,42	107,4	13,26	295,6	17,050	0,2689	0,2747	0,3288	410
SNEEZEWORTH	250.0	AA	7 x 4,80	127,6	14,40	349,3	20,120	0,2273	0,2324	0,2784	455
VALERIAN	250.0	A	19 x 2,91	126,4	14,55	349,3	20,740	0,2273	0,2324	0,2784	455
DAISY	266.8	AA	7 x 4,96	135,3	14,88	372,0	21,500	0,2133	0,2181	0,2610	475
LAUREL	266.8	A	19 x 3,01	135,2	15,05	372,0	22,120	0,2133	0,2181	0,2610	475
PEONY	300.0	A	19 x 3,19	151,9	15,95	419,1	24,380	0,1897	0,1945	0,2324	515
TULIP	336.4	A	19 x 3,38	170,5	16,90	470,0	27,370	0,1691	0,1734	0,2076	555
DAFFODIL	350.0	A	19 x 3,45	177,6	17,25	489,0	28,450	0,1626	0,1666	0,1995	565
CANNA	397.5	A,AA	19 x 3,68	202,1	18,40	555,4	31,640	0,1431	0,1473	0,1659	615
GOLDENTUFT	450.0	AA	19 x 3,91	228,1	19,55	682,6	35,110	0,1264	0,1299	0,1560	665
COSMOS	477.0	AA	19 x 4,02	241,2	20,10	666,4	37,200	0,1193	0,1224	0,1467	690
SYRINGA	477.0	A	37 x 2,88	241,0	20,16	666,4	38,670	0,1193	0,1224	0,1467	690
ZINNIA	500.0	AA	19 x 4,12	253,3	20,60	698,6	38,980	0,1138	0,1168	0,1398	715
HYACINTH	500.0	A	37 x 2,95	252,9	20,65	698,6	40,540	0,1138	0,1168	0,1398	715
DAHLIA	556.5	AA	19 x 4,35	282,4	21,75	777,4	43,390	0,1022	0,1089	0,1262	765
MISTLETOE	556.5	A	37 x 3,11	281,1	21,77	777,4	44,250	0,1022	0,1089	0,1262	765
MEADOWSEET	600.0	A,AA	37 x 3,23	303,2	22,61	838,1	47,620	0,09482	0,09820	0,01168	800
ORCHID	636.0	A,AA	37 x 3,33	322,2	23,31	880,4	50,730	0,08947	0,09262	0,11063	835
HEUCHERA	650.0	AA	37 x 3,37	330,0	23,59	908,1	51,840	0,08747	0,09098	0,10853	855
VERBENA	700.0	AA	37 x 3,49	354,0	24,43	977,9	55,630	0,08123	0,08451	0,10069	880
FLAG	700.0	A	61 x 2,72	354,5	24,48	977,9	57,415	0,08123	0,08451	0,10069	880
VIOLET	715.5	AA	37 x 3,53	362,1	24,71	999,6	56,960	0,07953	0,08264	0,09820	900
NASTURTIUM	715.5	A	61 x 2,75	362,3	24,75	999,6	58,300	0,07953	0,08264	0,09820	900
PETUNIA	750,0	AA	37 x 3,62	380,8	25,34	1 047,7	58,300	0,07585	0,07894	0,09446	922
CATTAIL	750,0	A	61 x 2,82	381,0	25,38	1 047,7	60,080	0,07585	0,07894	0,09446	922
ARBUTUS	795,0	AA	37 x 3,72	402,1	26,04	1 110,6	61,860	0,07156	0,07457	0,8888	960
LILAC	795,0	A	61 x 2,90	402,9	26,10	1 110,6	63,650	0,07156	0,07457	0,8888	960
FUCHSIA	800,0	AA	37 x 3,75	408,7	26,25	1 115,2	62,300	0,07116	0,07421	0,08825	960
HELIOTROPE	800,0	A	61 x 2,92	408,5	26,28	1 115,2	64,080	0,07116	0,07421	0,08825	960

Code word	Size (AWG)	Class	Composition	Conductor area (mm ²)	Outer diameter (mm)	Linear mass (Kg/km)	Rated strength (kN)	Electrical resist. d.c. 20°C (Ω/km)	Electrical resist. a.c. 25°C (Ω/km)	Electrical resist. a.c. 75°C (Ω/km)	Current carrying capacity A (I)
ANEMONE	874,5	AA	37 x 3,91	444,3	27,37	1 221,8	66,750	0,06506	0,06837	0,08081	1 020
CROCUS	874,5	A	61 x 3,04	442,8	27,36	1 221,8	70,310	0,06506	0,06837	0,08081	1 020
COCKCOMB	900,0	AA	37 x 3,96	455,7	27,72	1 257,4	68,530	0,06332	0,06650	0,07894	1 040
SNAPDRAGON	900,0	A	61 x 3,09	457,4	27,81	1 257,4	70,760	0,06332	0,06650	0,07894	1 040
MAGNOLIA	954,0	AA	37 x 4,08	483,7	28,56	1 332,8	72,980	0,05965	0,06276	0,07457	1 080
GOLDENROD	954,0	A	61 x 3,18	484,5	28,62	1 332,8	72,215	0,05965	0,06276	0,07457	1 080
HAWKWEED	1000,0	AA	37 x 4,17	505,3	29,19	1 397,0	76,540	0,05689	0,06004	0,07146	1 110
CAMELLIA	1000,0	A	61 x 3,25	506,0	29,25	1 397,0	78,770	0,05689	0,06004	0,07146	1 110
BLUEBELL	1033,5	AA	37 x 4,24	522,4	29,68	1 443,8	78,770	0,05505	0,05830	0,06906	1 135
LARKSPUR	1033,5	A	61 x 3,31	524,9	29,79	1 443,8	81,450	0,05505	0,05830	0,06906	1 135
MARIGOLD	1113,	A,AA	61 x 3,43	563,6	30,87	1 555,2	87,670	0,05112	0,05456	0,06437	1 190
HAWTHORN	1192,5	A,AA	61 x 3,55	603,8	31,95	1 665,3	93,900	0,04770	0,05121	0,06033	1 240
NARCISSUS	1272,0	A,AA	61 x 3,67	645,3	33,03	1 776,9	97,900	0,04472	0,04816	0,05673	1 290
COLUMBINE	1351,5	A,AA	61 x 3,78	684,5	34,02	1 888,5	104,130	0,04209	0,04560	0,05377	1 340
CARNATION	1431,0	A,AA	61 x 3,89	725,0	35,01	1 998,6	108,140	0,03976	0,04344	0,05102	1 390
GLADIOLUS	1510,0	A,AA	61 x 4,00	766,5	36,00	2 110,3	113,920	0,03766	0,04134	0,04852	1 430
COREOPSIS	1590,0	AA	61 x 4,10	805,4	36,90	2 222,0	120,150	0,03579	0,03960	0,04636	1 480
JESSAMINE	1750,0	AA	61 x 4,30	885,8	38,70	2 445,1	132,170	0,03251	0,03642	0,04262	1 565

Note 1 – With the following conditions: Ambient temperature = 25°C; Conductors' temperature = 75°C; Wind velocity = 0,6 m/s. Without solar radiation.

Note 2 – Outer layer stranding direction: Right-hand (Z).

APPLICATION

Conductor for aerial power lines of medium, high and extra high voltage.

CONSTRUCTION CHARACTERISTICS

Conductors are formed by aluminium alloy wires, concentrically stranded in layers.

All wires have the same nominal diameter.

AAAC – “All Aluminium Alloy Conductors”

GENERAL CHARACTERISTICS

The aluminium alloy has a tensile strength capacity higher than AL1 aluminium

Aluminium alloy with a conductivity between 52,5 and 53% IACS

The ratio tensile/weight is higher than standard AAC cables

The resistance to corrosion exceeds that of ACSR cables

ELECTRICAL AND DIMENSIONAL CHARACTERISTICS

CENELEC EN50182:2001 standard

Characteristics of aluminium alloy conductors – Type AL 3 – Spain

Code	Old code	Conductor area (mm ²)	N.º of wires	Wire diameter (mm)	Nominal diameter (mm)	Linear mass (kg/km)	Rated strength (kN)	Electrical resist. d.c. 20°C (Ω/km)
28-AL3	D 28	27,8	7	2,25	6,75	76,0	8,21	1,1817
43-AL3	D 40	43,1	7	2,80	8,40	117,7	12,72	0,7631
55-AL3	D 56	54,6	7	3,15	9,45	148,9	16,096	0,6029
76-AL3	D 80	75,5	19	2,25	11,3	207,4	22,29	0,4378
117-AL3	D 110	117,0	19	2,80	14,0	321,2	34,51	0,2827
148-AL3	D 145	148,1	19	3,15	15,8	406,5	43,68	0,2234
188-AL3	D 180	188,1	19	3,55	17,8	516,3	55,48	0,1759
279-AL3	D 280	279,3	37	3,10	21,7	769,3	82,38	0,1188
381-AL3	D 400	381,0	61	2,82	25,4	1 053,0	112,39	0,0874
454-AL3	D 450	454,5	61	3,08	27,7	1 256,1	134,07	0,0733
547-AL3	D 550	547,3	61	3,38	30,4	1 512,7	161,46	0,0608
638-AL3	D 630	638,3	61	3,65	32,9	1 764,0	188,29	0,0522

Note 1 – Outer layer stranding direction: Right-hand (Z).



CENELEC EN50182:2001 standard

Characteristics of aluminium alloy conductors – Type AL 3 – United Kingdom

Code number	Previous code word	Conductor area (mm ²)	N.° of wires	Wire diameter (mm)	Nominal diameter (mm)	Linear mass (kg/km)	Rated strength (kN)	Electrical resist. d.c. 20°C (Ω/km)
24-AL3	ACACIA	23,8	7	2,08	6,24	64,9	7,02	1,3828
30-AL3	ALMOND	30,1	7	2,34	7,02	82,2	8,88	1,0926
35-AL3	CEDAR	35,5	7	2,54	7,62	96,8	10,46	0,9273
42-AL3	DEODAR	42,2	7	2,77	8,31	115,2	12,44	0,7797
48-AL3	FIR	47,8	7	2,95	8,85	130,6	14,11	0,6875
60-AL3	HAZEL	59,9	7	3,30	9,90	163,4	17,66	0,5494
72-AL3	PINE	71,6	7	3,61	10,8	195,6	21,14	0,4591
84-AL3	HOLLY	84,1	7	3,91	11,7	229,5	24,79	0,3913
90-AL3	WILLOW	89,7	7	4,04	12,1	245,0	26,47	0,3665
119-AL3	OAK	118,9	7	4,65	14,0	324,5	35,07	0,2767
151-AL3	MULBERRY	150,9	19	3,18	15,9	414,3	44,52	0,2192
181-AL3	ASH	180,7	19	3,48	17,4	496,1	53,31	0,1830
211-AL3	ELM	211,0	19	3,76	18,8	579,2	62,24	0,1568
239-AL3	POPLAR	239,4	37	2,87	20,1	659,4	70,61	0,1387
303-AL3	SYCAMORE	303,2	37	3,23	22,6	835,2	89,40	0,1095
362-AL3	UPAS	362,1	37	3,53	24,7	997,5	106,82	0,0917
479-AL3	YEW	479,0	37	4,06	28,4	1 319,6	141,31	0,0693
498-AL3	TOTARA	498,1	37	4,14	29,0	1 372,1	146,93	0,0666
587-AL3	RUBUS	586,9	61	3,50	31,5	1 622,0	173,13	0,0567
659-AL3	SORBUS	659,4	61	3,71	33,4	1 822,5	194,53	0,0505
821-AL3	ARAUCARIA	821,1	61	4,14	37,3	2 269,4	242,24	0,0406
996-AL3	REDWOOD	996,2	61	4,56	41,0	2 753,2	293,88	0,0334

Note 1 – Outer layer stranding direction: Right-hand (Z).

CENELEC EN50182:2001 standard

Characteristics of aluminium alloy conductors features – Type AL 3 – Germany

Code	Old code	Conductor area (mm ²)	N.° of wires	Wire diameter (mm)	Nominal diameter (mm)	Linear mass (Kg/km)	Rated strength (kN)	Electrical resist. c.c 20°C (Ω/km)	Final modulus of elasticity (N/mm ²)	Final coefficient of linear expansion (1/K)	Current carrying capacity A (1)
16-AL3	16	15,9	7	1,70	5,10	43,4	4,69	2,0701	60 000	2,30E-05	105
24-AL3	25	24,2	7	2,10	6,30	66,2	7,15	1,3566	60 000	2,30E-05	135
34-AL3	35	34,4	7	2,50	7,50	93,8	10,14	0,9572	60 000	2,30E-05	170
49-AL3	50	49,5	7	3,00	9,00	135,1	14,60	0,6647	60 000	2,30E-05	210
48-AL3	50	48,3	19	1,80	9,00	132,7	14,26	0,6841	57 000	2,30E-05	210
66-AL3	70	65,8	19	2,10	10,5	180,7	19,41	0,5026	57 000	2,30E-05	255
93-AL3	95	93,3	19	2,50	12,5	256,0	27,51	0,3546	57 000	2,30E-05	320
117-AL3	120	117,0	19	2,80	14,0	321,2	34,51	0,2827	57 000	2,30E-05	365
147-AL3	150	147,1	37	2,25	15,8	405,3	43,40	0,2256	57 000	2,30E-05	425
182-AL3	185	181,6	37	2,50	17,5	500,3	53,58	0,1827	57 000	2,30E-05	490
243-AL3	240	242,5	61	2,25	20,3	670,3	71,55	0,1373	55 000	2,30E-05	585
299-AL3	300	299,4	61	2,50	22,5	827,5	88,33	0,1112	55 000	2,30E-05	670
400-AL3	400	400,1	61	2,89	26,0	1 105,9	118,04	0,0832	55 000	2,30E-05	810
500-AL3	500	499,8	61	3,23	29,1	1 381,4	147,45	0,0666	55 000	2,30E-05	930
626-AL3	625	626,2	91	2,96	32,6	1 737,7	184,73	0,0534	55 000	2,30E-05	1 075
802-AL3	800	802,1	91	3,35	36,9	2 225,8	236,62	0,0417	55 000	2,30E-05	1 255
1000-AL3	1 000	999,7	91	3,74	41,1	2 774,3	294,91	0,0334	55 000	2,30E-05	1 450

Note 1 – (1) Guideline values of current carrying capacity are valid up to a frequency of 60 Hz, assuming a wind velocity of 0,6 m/s, the effect of solar radiation for Germany, an initial ambient temperature of 35° C and a conductor temperature of 80° C. For special applications, when there is no air turbulence, the values should be reduced by 30 %.

Note 2 – Values of final modulus of elasticity and coefficient of linear expansion for the conductor sizes listed in the Table are used in Germany. Values for other conductor constructions may be calculated using the method given in IEC 61597.

Note 3 – Outer layer stranding direction: Right-hand (Z).

CENELEC EN 50182 standard

Characteristics of aluminium alloy conductors – Type AL 4 – France

Code	Previous code	Conductor area	N. ^o of wires	Wire diameter	Nominal diameter	Linear mass	Rated strength	Electrical resist. d.c. 20°C	Final modulus of elasticity	Final coefficient of linear expansion
	ASTER	(mm ²)		(mm)	(mm)	(Kg/km)	(kN)	(Ω/km)	(N/mm ²)	(1/K)
22-AL4	22	22,0	7	2,00	6,00	60,0	7,15	1,4989	62 000	2,30E-05
34-AL4	34,4	34,4	7	2,50	7,50	93,8	11,17	0,9593	62 000	2,30E-05
55-AL4	54,6	54,6	7	3,15	9,45	148,9	17,73	0,6042	62 000	2,30E-05
76-AL4	75,5	75,5	19	2,25	11,3	207,4	24,55	0,4388	60 000	2,30E-05
117-AL4	117	117,0	19	2,80	14,0	321,2	38,02	0,2833	60 000	2,30E-05
148-AL4	148	148,1	19	3,15	15,8	406,5	48,12	0,2239	60 000	2,30E-05
182-AL4	181,6	181,6	37	2,50	17,5	500,3	59,03	0,1831	57 000	2,30E-05
228-AL4	228	227,8	37	2,80	19,6	627,6	74,04	0,1460	57 000	2,30E-05
288-AL4	288	288,3	37	3,15	22,1	794,3	93,71	0,1154	57 000	2,30E-05
366-AL4	366	366,2	37	3,55	24,9	1 008,9	115,36	0,0908	57 000	2,30E-05
570-AL4	570	570,2	61	3,45	31,1	1 576,0	185,33	0,0585	54 000	2,30E-05
851-AL4	851	850,7	91	3,45	38,0	2 360,7	276,47	0,0394	52 000	2,30E-05
1144-AL4	1 144	1 143,5	91	4,00	44,0	3 173,4	360,22	0,0293	52 000	2,30E-05
1596-AL4	1 600	1 595,9	127	4,00	52,0	4 427,5	502,72	0,0210	50 500	2,30E-05

Note 1 – Outer layer stranding direction: Left-hand (S).

Note 2 – Values of final modulus of elasticity and coefficient of linear expansion for the conductor sizes listed in the Table are used in France. Values for other conductor constructions may be calculated using the method given in IEC 61597.

ASTM B-399 standard
Characteristics of aluminium alloy conductors – Countries with North American influence

Code word	Conductor size (MCM)	Composition		Outer diam. (mm)	Conductor area (mm ²)	ACSR size of equivalent diameter	E.C. size of equivalent resistance	Linear mass (Kg/km)	Rated strength (N)	Electrical resistance (Ω/km)			Current carrying capacity A (1)
		N.°	Ø (mm)							d.c. 20°C	a.c. 25°C	a.c. 75°C	
AKRON	30,58	7	1,68	5,04	15,52	6-6/1	6	42,7	4 920	2,1614	2,1995	2,5754	110
ALTON	48,69	7	2,12	6,36	24,70	4-6/1	4	68,0	7 840	1,3576	1,3816	1,6175	150
AMES	77,47	7	2,67	8,01	39,19	2-6/1	2	108,2	12 500	0,8533	0,8694	1,0171	200
AZUSA	123,3	7	3,37	10,11	62,44	1/0-6/1	1/0	172,2	19 000	0,5364	0,5456	0,6398	270
ANAHEIM	155,4	7	3,78	11,34	78,55	2/0-6/1	2/0	217,1	24 000	0,4255	0,4331	0,5072	315
AMHERST	195,7	7	4,25	12,75	99,30	3/0-6/1	3/0	273,4	30 200	0,3379	0,3445	0,4035	365
ALLIANCE	246,9	7	4,77	14,31	125,09	4/0-6/1	4/0	345,0	38 100	0,2658	0,2740	0,3199	420
BUTTE	312,8	19	3,26	16,30	158,59	266-26/7	266	436,9	46 700	0,2114	0,2156	0,2523	490
CANTON	394,5	19	3,66	18,30	199,89	336-26/7	336	551,1	59 000	0,1675	0,1713	0,2001	570
CAIRO	465,4	19	3,98	19,90	236,38	397-26/7	397	650,2	69 600	0,1421	0,1453	0,1698	640
DARIEN	559,5	19	4,36	21,80	283,67	477-26/7	477	781,6	83 600	0,1181	0,1211	0,1414	720
ELGIN	652,4	19	4,71	23,55	331,04	556-26/7	536	911,4	97 500	0,1013	0,1043	0,1217	790
FLINT	740,8	37	3,59	25,13	374,52	636-26/7	636	1,035	108 000	0,08924	0,09219	0,1073	860
GREELEY	927,2	37	4,02	28,14	469,62	795-26/7	795	1,295	136 000	0,07129	0,07415	0,08629	990

Note 1 – With the following conditions: Ambient temperature = 25°C;

conductors' temperature = 75°C;

Wind velocity = 0,6 m/s. No full sun (Without solar radiation).

Note 2 – Outer layer stranding direction: Right-hand (Z).

We reserve the right to modify, at any time, without any obligation and without notice, the specifications and other technical data in this document, which must be confirmed when ordering.



APPLICATION

Conductor used as power ground wire for protection of aerial power lines of medium, high and extra high voltage. Indicated for aerial lines with long span lengths.

CONSTRUCTION CHARACTERISTICS

Conductors are made of one or several layers of hard drawn aluminium wires stranded in concentric layers around a galvanized steel core. The steel core can be impregnated with protective grease. To bring the cable to specific applications, it is possible to vary the relative proportion of the cross-sectional area of aluminium and steel.

ACSR – "Aluminium Conductor Steel Reinforced"

GENERAL CHARACTERISTICS

Good resistance to corrosion.

Good ratio for strength/weight. Allows the use in long span lengths.



ELECTRICAL AND DIMENSIONAL CHARACTERISTICS

CENELEC EN50182:2001 standard

Characteristics of aluminium conductors steel reinforced – Type AL1 / ST1A – Spain

Code	Old code	Cross-section			Composition				Diameter		Linear mass (kg/km)	Rated strength (kN)	Electrical resist. d.c. 20°C (Ω/km)
		Alum. (mm ²)	Steel (mm ²)	Total (mm ²)	Aluminium		Steel		Steel core (mm)	Conductor (mm)			
					N.º of wires	Diam. (mm)	N.º of wires	Diam. (mm)					
27-AL1/4-ST1A	LA 30	26,7	4,45	31,1	6	2,38	1	2,38	2,38	7,14	107,8	9,74	1,0736
47-AL1/8-ST1A	LA 56	46,8	7,79	54,6	6	3,15	1	3,15	3,15	9,45	188,8	16,29	0,6129
67-AL1/11-ST1A	LA 78	67,3	11,2	78,6	6	3,78	1	3,78	3,78	11,3	271,8	23,12	0,4256
94-AL1/22-ST1A	LA 110	94,2	22,0	116,2	30	2,00	7	2,00	6,00	14,0	432,5	43,17	0,3067
119-AL1/28-ST1A	LA 145	119,3	27,8	147,1	30	2,25	7	2,25	6,75	15,8	547,4	54,03	0,2423
147-AL1/34-ST1A	LA 180	147,3	34,4	181,6	30	2,50	7	2,50	7,50	17,5	675,8	64,94	0,1963
242-AL1/39-ST1A	LA 280 HAWK	241,6	39,5	281,1	26	3,44	7	2,68	8,04	21,8	976,2	84,89	0,1195
337-AL1/44-ST1A	LA 380 GULL	337,3	43,7	381,0	54	2,82	7	2,82	8,46	25,4	1 274,6	107,18	0,0857
402-AL1/52-ST1A	LA 455 CONDOR	402,3	52,2	454,5	54	3,08	7	3,08	9,24	27,7	1 520,5	123,75	0,0719
485-AL1/63-ST1A	LA 545 CARDINAL	484,5	62,8	547,3	54	3,38	7	3,38	10,1	30,4	1 831,1	149,04	0,0597
565-AL1/72-ST1A	LA 635 FINCH	565,0	71,6	636,6	54	3,65	19	2,19	11,0	32,9	2 123,0	174,14	0,0512

Note 1 – Outer layer stranding direction: Right-hand (Z).

CENELEC EN50182:2001 standard

Characteristics of aluminium conductors steel reinforced – Type AL1/ST1A – United Kingdom

Code number	Old code	Cross-section			Composition				Diameter		Linear mass (kg/km)	Rated strength (kN)	Electrical resist. d.c. 20°C (Ω/km)
		Alum. (mm ²)	Steel (mm ²)	Total (mm ²)	Aluminium		Steel		Steel core (mm)	Conductor (mm)			
					N.º of wires	Diam. (mm)	N.º of wires	Diam. (mm)					
11-AL1/2-ST1A	MOLE	10,6	1,77	12,4	6	1,50	1	1,50	1,50	4,50	42,8	4,14	2,7027
21-AL1/3-ST1A	SQUIRREL	21,0	3,50	24,5	6	2,11	1	2,11	2,11	6,33	84,7	7,87	1,3659
26-AL1/4-ST1A	GOPHER	26,2	4,37	30,6	6	2,36	1	2,36	2,36	7,08	106,0	9,58	1,0919
32-AL1/5-ST1A	WEASEL	31,6	5,27	36,9	6	2,59	1	2,59	2,59	7,77	127,6	11,38	0,9065
37-AL1/6-ST1A	FOX	36,7	6,11	42,8	6	2,79	1	2,79	2,79	8,37	148,1	13,21	0,7812
42-AL1/7-ST1A	FERRET	42,4	7,07	49,5	6	3,00	1	3,00	3,00	9,00	171,2	15,27	0,6757
53-AL1/9-ST1A	RABBIT	52,9	8,81	61,7	6	3,35	1	3,35	3,35	10,1	213,5	18,42	0,5419
63-AL1/11-ST1A	MINK	63,1	10,5	73,6	6	3,66	1	3,66	3,66	11,0	254,9	21,67	0,4540
63-AL1/37-ST1A	SKUNK	63,2	36,9	100,1	12	2,59	7	2,59	7,77	13,0	463,0	52,79	0,4568

We reserve the right to modify, any time, without any obligation and without prior notice, the specifications and other technical data in this document, which must be confirmed when ordering.

Code number	Old code	Cross-section			Composition				Diameter		Linear mass (kg/km)	Rated strength (kN)	Electrical resist. d.c. 20°C (Ω/km)
		Alum. (mm ²)	Steel (mm ²)	Total (mm ²)	Aluminium N.° of wires (mm)	Steel N.° of wires (mm)	Steel core (mm)	Conductor (mm)					
									Diam. (mm)	Diam. (mm)			
75-AL1/13-ST1A	BEAVER	75,0	12,5	87,5	6	3,99	1	3,99	3,99	12,0	302,9	25,76	0,3820
73-AL1/43-ST1A	HORSE	73,4	42,8	116,2	12	2,79	7	2,79	8,37	14,0	537,3	61,26	0,3936
79-AL1/13-ST1A	RACoon	78,8	13,1	92,0	6	4,09	1	4,09	4,09	12,3	318,3	27,06	0,3635
84-AL1/14-ST1A	OTTER	83,9	14,0	97,9	6	4,22	1	4,22	4,22	12,7	338,8	28,81	0,3415
95-AL1/16-ST1A	CAT	95,4	15,9	111,3	6	4,50	1	4,50	4,50	13,5	385,3	32,76	0,3003
105-AL1/17-ST1A	HARE	105,0	17,5	122,5	6	4,72	1	4,72	4,72	14,2	423,8	36,04	0,2730
105-AL1/14-ST1A	DOG	105,0	13,6	118,5	6	4,72	7	1,57	4,71	14,2	394,0	32,65	0,2733
132-AL1/20-ST1A	COYOTE	131,7	20,1	151,8	26	2,54	7	1,91	5,73	15,9	520,7	45,86	0,2192
132-AL1/7-ST1A	COUGAR	131,5	7,31	138,8	18	3,05	1	3,05	3,05	15,3	418,8	29,74	0,2188
131-AL1/31-ST1A	TIGER	131,2	30,6	161,9	30	2,36	7	2,36	7,08	16,5	602,2	57,87	0,2202
158-AL1/37-ST1A	WOLF	158,1	36,9	194,9	30	2,59	7	2,59	7,77	18,1	725,3	68,91	0,1829
159-AL1/9-ST1A	DINGO	158,7	8,81	167,5	18	3,35	1	3,35	3,35	16,8	505,2	35,87	0,1814
183-AL1/43-ST1A	LYNX	183,4	42,8	226,2	30	2,79	7	2,79	8,37	19,5	841,6	79,97	0,1576
184-AL1/10-ST1A	CARACAL	184,2	10,2	194,5	18	3,61	1	3,61	3,61	18,1	586,7	40,74	0,1562
212-AL1/49-ST1A	PANTEHR	212,1	49,5	261,5	30	3,00	7	3,00	9,00	21,0	973,1	92,46	0,1363
211-AL1/12-ST1A	JAGUAR	210,6	11,7	222,3	18	3,86	1	3,86	3,86	19,3	670,8	46,57	0,1366
238-AL1/56-ST1A	LION	238,3	55,6	293,9	30	3,18	7	3,18	9,54	22,3	1 093,4	100,47	0,1213
264-AL1/62-ST1A	BEAR	264,4	61,7	326,1	30	3,35	7	3,35	10,1	23,5	1 213,4	111,50	0,1093
324-AL1/76-ST1A	GOAT	324,3	75,7	400,0	30	3,71	7	3,71	11,1	26,0	1 488,2	135,13	0,0891
375-AL1/88-ST1A	SHEEP	375,1	87,5	462,6	30	3,99	7	3,99	12,0	27,9	1 721,3	156,30	0,0771
374-AL1/48-ST1A	ANTELOPE	374,1	48,5	422,6	54	2,97	7	2,97	8,91	26,7	1 413,8	118,88	0,0773
382-AL1/49-ST1A	BISON	381,7	49,5	431,2	54	3,00	7	3,00	9,00	27,0	1 442,5	121,30	0,0758
430-AL1/100-ST1A	DEER	429,6	100,2	529,8	30	4,27	7	4,27	12,8	29,9	1 971,4	179,00	0,0673
429-AL1/56-ST1A	ZEBRA	428,9	55,6	484,5	54	3,18	7	3,18	9,54	28,6	1 620,8	131,92	0,0674
477-AL1/111-ST1A	ELK	477,1	111,3	588,5	30	4,50	7	4,50	13,5	31,5	2 189,5	198,80	0,0606
476-AL1/62-ST1A	CAMEL	476,0	61,7	537,7	54	3,35	7	3,35	10,1	30,2	1 798,8	146,40	0,0608
528-AL1/69-ST1A	MOOSE	528,5	68,5	597,0	54	3,53	7	3,53	10,6	31,8	1 997,3	159,92	0,0547

Note 1 – Outer layer stranding direction: Right-hand (Z).



We reserve the right to modify, at any time, without any obligation and without prior notice, the specifications and other technical data in this document, which must be confirmed when ordering.



CENELEC EN50182:2001 standard
 Characteristics of aluminium conductors steel reinforced – Type AL1/ST1A – Germany

Code number	Old code	Cross-section			N.° of wires		Nominal diameter		Diameter		Linear mass (kg/km)	Rated strength (kN)	Electrical resistance d.c. 20°C (Ω/km)	Final modulus of elasticity (N/mm²)	Final coefficient of thermal expansion (1/K)	Current carrying capacity A (I)
		Alum. (mm²)	Steel (mm²)	Total (mm²)	Alum.	Steel	Alum. (mm)	Steel (mm)	Core (mm)	Cond. (mm)						
15-AL1/3-ST1A	16/2,5	15,3	2,54	17,8	6	1,80	1	1,80	1,80	5,40	61,6	5,80	1,8769	81 000	1,92E-05	105
24-AL1/4-ST1A	25/4	23,9	3,98	27,8	6	2,25	1	2,25	2,25	6,75	96,3	8,95	1,2012	81 000	1,92E-05	140
34-AL1/6-ST1A	35/6	34,4	5,73	40,1	6	2,70	1	2,70	2,70	8,10	138,7	12,37	0,8342	81 000	1,92E-05	170
44-AL1/32-ST1A	44/32	44,0	31,7	75,6	14	2,00	7	2,40	7,20	11,2	369,3	44,24	0,6574	110 000	1,50E-05	--
48-AL1/8-ST1A	50/8	48,3	8,04	56,3	6	3,20	1	3,20	3,20	9,60	194,8	16,81	0,5939	81 000	1,92E-05	210
51-AL1/30-ST1A	50/30	51,2	29,8	81,0	12	2,33	7	2,33	6,99	11,7	374,7	42,98	0,5644	107 000	1,53E-05	--
70-AL1/11-ST1A	70/12	69,9	11,4	81,3	26	1,85	7	1,44	4,32	11,7	282,2	26,27	0,4132	77 000	1,89E-05	290
94-AL1/15-ST1A	95/15	94,4	15,3	109,7	26	2,15	7	1,67	5,01	13,6	380,6	34,93	0,3060	77 000	1,89E-05	350
97-AL1/56-ST1A	95/55	96,5	56,3	152,8	12	3,20	7	3,20	9,60	16,0	706,8	77,85	0,2992	107 000	1,53E-05	--
106-AL1/76-ST1A	105/75	105,7	75,5	181,2	14	3,10	19	2,25	11,3	17,5	885,3	105,82	0,2742	110 000	1,50E-05	--
122-AL1/20-ST1A	120/20	121,6	19,8	141,4	26	2,44	7	1,90	5,70	15,5	491,0	44,50	0,2376	77 000	1,89E-05	410
122-AL1/71-ST1A	120/70	122,1	71,3	193,4	12	3,60	7	3,60	10,8	18,0	894,5	97,92	0,2364	107 000	1,53E-05	--
128-AL1/30-ST1A	125/30	127,9	29,8	157,8	30	2,33	7	2,33	6,99	16,3	587,0	56,41	0,2260	82 000	1,78E-05	425
149-AL1/24-ST1A	150/25	148,9	24,2	173,1	26	2,70	7	2,10	6,30	17,1	600,8	53,67	0,1940	77 000	1,89E-05	470
172-AL1/40-ST1A	170/40	171,8	40,1	211,8	30	2,70	7	2,70	8,10	18,9	788,2	74,89	0,1683	82 000	1,78E-05	520
184-AL1/30-ST1A	185/30	183,8	29,8	213,6	26	3,00	7	2,33	6,99	19,0	741,0	65,27	0,1571	77 000	1,89E-05	535
209-AL1/34-ST1A	210/35	209,1	34,1	243,2	26	3,20	7	2,49	7,47	20,3	844,1	73,36	0,1381	77 000	1,89E-05	590
212-AL1/49-ST1A	210/50	212,1	49,5	261,5	30	3,00	7	3,00	9,00	21,0	973,1	92,46	0,1363	82 000	1,78E-05	610
231-AL1/30-ST1A	230/30	230,9	29,8	260,8	24	3,50	7	2,33	6,99	21,0	870,9	72,13	0,1250	74 000	1,96E-05	630
243-AL1/39-ST1A	240/40	243,1	39,5	282,5	26	3,45	7	2,68	8,04	21,8	980,1	85,12	0,1188	77 000	1,89E-05	645
264-AL1/34-ST1A	265/35	263,7	34,1	297,7	24	3,74	7	2,49	7,47	22,4	994,4	81,04	0,1095	74 000	1,96E-05	680
304-AL1/49-ST1A	300/50	304,3	49,5	353,7	26	3,86	7	3,00	9,00	24,4	1 227,3	105,09	0,0949	77 000	1,89E-05	740
305-AL1/39-ST1A	305/40	304,6	39,5	344,1	54	2,68	7	2,68	8,04	24,1	1 151,2	96,80	0,0949	70 000	1,93E-05	740
339-AL1/30-ST1A	340/30	339,3	29,8	369,1	48	3,00	7	2,33	6,99	25,0	1 171,2	91,71	0,0852	62 000	2,05E-05	790
382-AL1/49-ST1A	380/50	381,7	49,5	431,2	54	3,00	7	3,00	9,00	27,0	1 442,5	121,30	0,0758	70 000	1,93E-05	840
386-AL1/34-ST1A	385/35	386,0	34,1	420,1	48	3,20	7	2,49	7,47	26,7	1 333,6	102,56	0,0749	62 000	2,05E-05	850
434-AL1/56-ST1A	435/55	434,3	56,3	490,6	54	3,20	7	3,20	9,60	28,8	1 641,3	133,59	0,0666	70 000	1,93E-05	900
449-AL1/39-ST1A	450/40	448,7	39,5	488,2	48	3,45	7	2,68	8,04	28,7	1 549,1	119,05	0,0644	62 000	2,05E-05	920
490-AL1/64-ST1A	490/65	490,3	63,6	553,8	54	3,40	7	3,40	10,2	30,6	1 852,9	150,81	0,0590	70 000	1,93E-05	960
494-AL1/34-ST1A	495/35	494,4	34,1	528,4	45	3,74	7	2,49	7,47	29,9	1 632,6	117,96	0,0584	61 000	2,09E-05	985
511-AL1/45-ST1A	510/45	510,5	45,3	555,8	48	3,68	7	2,87	8,61	30,7	1 765,3	133,31	0,0566	62 000	2,05E-05	995

We reserve the right to modify, at any time, without any obligation and without prior notice, the specifications and other technical data in this document, which must be confirmed when ordering.



Code number	Old code	Cross-section			N.° of wires		Nominal diameter		Diameter	Linear mass	Rated strength	Electrical resistance d.c. 20°C	Final modulus of elasticity	Final coefficient of thermal expansion	Current carrying capacity
		Alum. (mm ²)	Steel (mm ²)	Total (mm ²)	Alum. (mm)	Steel (mm)	Core (mm)	Cond. (mm)							
550-AL1/71-ST1A	550/70	549,7	71,3	620,9	54	3,60	7	3,60	10,8	32,4	2 077,2	166,32	70 000	1,93E-05	1 020
562-AL1/49-ST1A	560/50	561,7	49,5	611,2	48	3,86	7	3,00	9,00	32,2	1 939,5	146,28	62 000	2,05E-05	1 040
571-AL1/39-ST1A	570/40	571,2	39,5	610,6	45	4,02	7	2,68	8,04	32,2	1 887,1	136,40	61 000	2,09E-05	1 050
653-AL1/45-ST1A	650/45	653,5	45,3	698,8	45	4,30	7	2,87	8,61	34,4	2 159,9	156,18	61 000	2,09E-05	1 120
679-AL1/86-ST1A	680/85	678,6	86,0	764,5	54	4,00	19	2,40	12,0	36,0	2 549,7	206,56	68 000	1,94E-05	1 150
1046-AL1/45-ST1A	1 045/45	1 045,6	45,3	1 090,9	72	4,30	7	2,87	8,61	43,0	3 248,2	218,92	60 000	2,17E-05	1 580

Note 1 – (1) The indicated ampacity (maximum permissible current) values are valid up to frequencies of 60 Hz, assuming a crosswind of 0,6m/s, the effect of solar radiation in Germany, an ambient temperature of 35°C and a conductor temperature of 80°C. For special applications, where there is no turbulence, the values are reduced by 30%.

Note 2 – Outer layer stranding direction: Right-hand (Z).

Note 3 – Values of final modulus of elasticity and coefficient of linear expansion for the conductor sizes listed in the Table are used in Germany. Values for other conductor constructions may be calculated using the method given in IEC 61597.

CENELEC EN50182:2001 standard characteristics of aluminium conductors steel reinforced – Type AL1/ST1A – France

Code number	Old code	Cross-section			Composition			Nominal diameter		Linear mass	Rated strength	Electrical resistance d.c. 20°C	Stranding direction	
		Alum. (mm ²)	Steel (mm ²)	Total (mm ²)	Aluminium	Steel	N.° of wires	N.° of diam. wires (mm)	Core (mm)					Cond. (mm)
28-AL1/9-ST1A	CANNA 37,7	28,3	9,42	37,7	9	2,00	3	2,00	4,30	8,30	151,5	16,26	1,0187	S
38-AL1/22-ST1A	CANNA 59,7	37,7	22,0	59,7	12	2,00	7	2,00	6,00	10,0	276,1	32,70	0,7660	S
48-AL1/28-ST1A	CANNA 75,5	47,7	27,8	75,5	12	2,25	7	2,25	6,75	11,3	349,4	41,15	0,6052	S
59-AL1/34-ST1A	CANNA 93,3	58,9	34,4	93,3	12	2,50	7	2,50	7,50	12,5	431,4	49,48	0,4902	Z
94-AL1/22-ST1A	CANNA 116,2	94,2	22,0	116,2	30	2,00	7	2,00	6,00	14,0	432,5	43,17	0,3067	S
119-AL1/28-ST1A	CANNA 147,1	119,3	27,8	147,1	30	2,25	7	2,25	6,75	15,8	547,4	54,03	0,2423	S
147-AL1/34-ST1A	CANNA 181,6	147,3	34,4	181,6	30	2,50	7	2,50	7,50	17,5	675,8	64,94	0,1963	S
185-AL1/43-ST1A	CANNA 228	184,7	43,1	227,8	30	2,80	7	2,80	8,40	19,6	847,7	80,54	0,1565	S
234-AL1/55-ST1A	CANNA 288	233,8	54,6	288,3	30	3,15	7	3,15	9,45	22,1	1 072,8	98,58	0,1236	S

Note – Values of final modulus of elasticity and coefficient of linear expansion for the conductor sizes listed in the Table are used in France. Values for other conductor constructions may be calculated using the method given in IEC 61597.

CENELEC EN50182:2001 standard
 Characteristics of aluminium conductors steel reinforced – Type AL1 / ST6C – France

Code number	Old code	Cross-section		Composition		Nominal diameter		Linear mass (kg/km)	Rated strength (kN)	Electrical resistance d.c. 20°C (Ω/km)	Stranding direction			
		Alum. (mm2)	Steel (mm2)	Total (mm2)	Aluminium	Steel	Core					Cond.		
													N° of wires (mm)	Diam. (mm)
94-AL1/22-ST6C	CROCUS 116,2	94,2	22,0	116,2	30	2,00	7	2,00	6,00	14,0	432,5	49,32	0,3067	S
119-AL1/28-ST6C	CROCUS 147,1	119,3	27,8	147,1	30	2,25	7	2,25	6,75	15,8	547,4	61,83	0,2423	S
147-AL1/34-ST6C	CROCUS 181,6	147,3	34,4	181,6	30	2,50	7	2,50	7,50	17,5	675,8	74,22	0,1963	S
185-AL1/43-ST6C	CROCUS 228	184,7	43,1	227,8	30	2,80	7	2,80	8,40	19,6	847,7	92,18	0,1565	S
234-AL1/55-ST6C	CROCUS 288	233,8	54,6	288,3	30	3,15	7	3,15	9,45	22,1	1 072,8	113,86	0,1236	S
222-AL1/76-ST6C	CROCUS 297	221,7	75,5	297,2	36	2,80	19	2,25	11,3	22,5	1 206,8	147,22	0,1307	Z
326-AL1/86-ST6C	CROCUS 412	325,7	86,0	411,7	32	3,60	19	2,40	12,0	26,4	1 576,1	173,31	0,0889	Z
508-AL1/105-ST6C	CROCUS 612	507,8	104,8	612,6	66	3,13	19	2,65	13,3	32,0	2 226,5	231,55	0,0570	S
717-AL1/148-ST6C	CROCUS 865	717,3	148,1	865,4	66	3,72	19	3,15	15,8	38,1	3 145,4	319,11	0,0403	S
957-AL1/228-ST6C	CROCUS 1185	956,7	227,8	1 184,5	54	2,80	37	2,80	19,6	44,7	4 433,6	480,75	0,0302	S

Note – Values of final modulus of elasticity and coefficient of linear expansion for the conductor sizes listed in the Table are used in France. Values for other conductor configurations may be calculated using the method given in IEC 61597.

ASTM B-232 standard
 Characteristics of aluminium conductors steel reinforced

Code word	Size	Composition		Cross-section		Outer diameter		Cable weight			Rated strength (N)	Electrical resistance (Ω/km)			Current carrying capacity A (I)
		Alum. (mm)	Steel (mm)	Total (mm2)	Alum. (mm2)	Total (mm)	Nucleo (mm)	Total (kg/km)	Alum. (kg/km)	Steel (kg/km)		d.c. 20°C	a.c. 25°C	a.c. 75°C	
TURKEY	6	6 x 1,68	1 x 1,68	15,52	13,30	5,04	1,68	53,8	36,5	17,3	5 295	2,1135	2,1496	2,6850	110
SWAN	4	6 x 2,12	1 x 2,12	24,71	21,18	6,36	2,12	85,4	58,0	27,4	8 280	1,3278	1,3537	1,7172	145
SWANATE	4	7 x 1,96	1 x 2,61	26,47	21,12	6,53	2,61	99,7	58,0	41,7	10 500	1,3133	1,3387	1,7383	145
SPARROW	2	6 x 2,67	1 x 2,67	39,20	33,60	8,01	2,67	135,9	92,3	43,6	12 680	0,8343	0,8527	1,1081	195
SPARATE	2	7 x 2,47	1 x 3,30	42,09	33,54	5,24	3,30	158,8	92,3	66,5	16 200	0,8251	0,8435	1,1181	195
ROBIN	1	6 x 3,00	1 x 3,00	49,48	42,41	9,00	3,00	171,4	116,4	55,0	15 800	0,6621	0,6768	0,8907	200
RAVEN	1/0	6 x 3,37	1 x 3,37	62,44	53,52	10,11	3,37	216,1	146,7	69,4	19 490	0,5243	0,5370	0,7165	255
QUAIL	2/0	6 x 3,78	1 x 3,78	78,55	67,33	11,34	3,78	272,5	185,0	87,5	23 630	0,4160	0,4265	0,5803	295
PIGEON	3/0	6 x 4,25	1 x 4,25	99,31	85,12	12,75	4,25	343,5	233,2	110,3	29 460	0,3304	0,3386	0,4705	340
PENGUIN	4/0	6 x 4,77	1 x 4,77	125,09	107,22	14,31	4,77	433,2	294,2	139,0	37 160	0,2618	0,2697	0,3829	390
WAXMING	266,8	18 x 3,09	1 x 3,09	142,5	135,0	15,45	3,09	431,6	372,9	58,7	30 620	0,2119	0,2169	0,2595	480
PARTRIDGE	266,8	26 x 2,57	7 x 2,00	156,9	134,9	16,28	6,00	546,1	374,3	171,8	50 280	0,2100	0,2146	0,2569	490

Code word	Size	Composition		Cross-section		Outer diameter		Cable weight			Rated strength (N)	Electrical resistance (Ω/km)			Current carrying capacity A (I)
		Alum. (mm)	Steel (mm)	Total (mm ²)	Alum. (mm ²)	Total (mm)	Nucleo (mm)	Total Kg/Km	Alum. kg/km	Steel kg/km		d.c. 20°C	a.c. 25°C	a.c. 75°C	
OSTRICH	300,0	26 x 2,73	7 x 2,12	176,9	152,2	17,28	6,36	614,6	421,3	193,3	56 520	0,1867	0,1909	0,2283	530
MERLIN	336,4	18 x 3,47	1 x 3,47	179,7	170,2	17,35	3,47	543,2	469,7	73,5	38 630	0,1680	0,1719	0,2057	560
LINNET	336,4	26 x 2,89	7 x 2,25	198,4	170,6	18,31	6,75	689,0	472,2	216,8	62 750	0,1663	0,1699	0,2037	570
ORTOLE	336,4	30 x 2,69	7 x 2,69	210,3	170,5	18,83	8,07	784,3	473,2	311,1	76 980	0,1654	0,1690	0,2024	575
CHICKADEE	397,5	18 x 3,77	1 x 3,77	212,1	200,9	18,85	3,77	642,9	555,5	87,4	44 230	0,1421	0,1457	0,1742	620
BRANT	397,5	24 x 3,27	7 x 2,18	227,7	201,6	19,62	6,54	762,0	558,1	203,9	64 970	0,1417	0,1450	0,1732	630
IBIS	397,5	26 x 3,14	7 x 2,44	234,0	201,3	19,88	7,32	814,0	558,2	255,8	72 530	0,1411	0,1444	0,1726	635
LARK	397,5	30 x 2,92	7 x 2,92	247,8	200,9	20,44	8,76	927,1	555,1	372,0	90 330	0,1401	0,1434	0,1726	645
PELICAN	477,0	18 x 4,14	1 x 4,14	255,8	242,3	20,70	4,14	770,9	666,4	104,5	52 510	0,1184	0,1217	0,1453	700
FLICKER	477,0	24 x 3,58	7 x 2,39	273,0	241,6	21,49	7,17	915,2	670,1	245,1	76 540	0,1178	0,1207	0,1444	710
HAWK	477,0	26 x 3,44	7 x 2,67	280,8	241,6	21,77	8,01	977,7	669,7	308,0	86 770	0,1171	0,1201	0,1437	715
HEN	477,0	30 x 3,20	7 x 3,20	297,6	241,3	22,40	9,60	1 111,7	671,0	440,7	105 910	0,1165	0,1194	0,1427	725
OSPREY	556,5	18 x 4,47	1 x 4,47	298,2	282,5	22,35	4,47	898,9	777,0	121,9	60 960	0,1014	0,1043	0,1247	775
PARAKEE	556,5	24 x 3,87	7 x 2,58	318,9	282,3	23,22	7,74	1 067,0	781,6	285,4	88 110	0,1010	0,1037	0,1240	785
DOVE	556,5	26 x 3,72	7 x 2,89	328,5	282,6	23,55	8,67	1 140,0	781,3	358,7	105 570	0,1007	0,1033	0,1237	790
EAGLE	556,5	30 x 3,46	7 x 3,46	347,9	282,1	24,27	10,38	1 297,7	783,2	514,5	123 710	0,1001	0,1027	0,1227	800
PEACOCK	605,0	24 x 4,03	7 x 2,69	345,9	306,1	24,19	8,07	1 160,8	849,8	311,0	96 120	0,9285	0,09547	0,11417	830
SQUAB	605,0	26 x 3,87	7 x 3,01	355,6	305,8	24,51	9,03	1 239,7	849,8	389,9	108 130	0,09252	0,09514	0,11352	835
WOODDUCK	605,0	30 x 3,61	7 x 3,61	378,7	307,1	25,27	10,83	1 410,8	851,2	559,6	128 600	0,03186	0,09449	0,11286	845
TEAL	605,0	30 x 3,61	19 x 2,16	376,7	307,1	25,24	10,80	1 398,9	851,5	547,4	135 500	0,09186	0,09449	0,11286	845
KINGBIRD	636,0	18 x 4,78	1 x 4,78	340,9	323,0	23,90	4,78	1 026,9	887,4	139,5	69 860	0,08891	0,09219	0,10925	840
ROOK	636,0	24 x 4,14	7 x 2,76	365,0	323,1	24,84	8,28	1 220	892,9	327	97 900	0,08825	0,09088	0,10827	855
GROSBREAK	636,0	26 x 3,97	7 x 3,09	374,3	321,8	25,15	9,27	1 302,2	892,6	409,6	112 140	0,08793	0,09055	0,10794	860
SCOTER	636,0	30 x 3,70	7 x 3,70	397,9	322,6	25,90	11,10	1 477,8	891,4	586,4	135 270	0,08760	0,08990	0,10761	870
EGRET	636,0	30 x 3,70	19 x 2,22	396,1	322,6	25,90	11,10	1 470,3	891,4	575,3	140 170	0,08760	0,08990	0,10761	870
SWIFT	636,0	36 x 3,38	1 x 3,38	332,0	232,0	23,66	3,58	958,4	888,4	70,0	61 410	0,08924	0,09186	0,10925	845

Note 1 – (1) With the following conditions: Ambient temperature = 25°C; Conductors' temperature = 75°C; Wind velocity = 0,6 m/s. Without solar radiation.
Note 2 – Outer layer stranding direction: Right-hand (Z).



We reserve the right to modify, at any time, without any obligation and without prior notice, the specifications and other technical data in this document, which must be confirmed when ordering.



ASTM B-232 standard
Characteristics of aluminium conductors steel reinforced

Code word	Size		Composition		Cross-section		Outer diameter		Cable weight			Rated strength		Electrical resistance (Ω/km)			Current carrying capacity A (I)
	Alum. (mm)	Steel (mm)	Total (mm ²)	Alum. (mm ²)	Total (mm)	Nucleo (mm)	Total (kg/Km)	Alum. (kg/km)	Steel (kg/km)	(N)	d.c. 20°C	a.c. 25°C	a.c. 75°C				
FLAMINGO	666,6	24 x 4,23	7 x 2,82	381,0	337,3	25,38	8,46	1 276,9	935,2	341,7	105 460	0,08432	0,08563	0,10367	880		
GANNET	666,6	26 x 4,07	7 x 3,16	393,2	338,3	25,76	9,48	1 364,7	936,1	428,6	117 480	0,08399	0,08497	0,10302	885		
STILT	715,5	24 x 4,39	7 x 2,92	410,2	363,3	26,32	8,76	1 372,1	1 004,5	367,6	113 470	0,07841	0,08104	0,09678	920		
STARLING	715,5	26 x 4,21	7 x 3,28	421,0	361,9	26,68	9,84	1 465,9	1 004,5	461,4	126 370	0,07808	0,080038	0,08613	930		
REDWING	715,5	30 x 3,92	19 x 2,35	444,5	362,1	27,43	11,75	1 653,4	1 007,1	646,3	153 960	0,07776	0,08005	0,09547	940		
CUCKOO	795,0	24 x 4,62	7 x 3,08	454,5	402,3	27,72	9,24	1 522,4	1 115,2	407,2	124 150	0,07087	0,07316	0,08727	985		
DRAKE	795,0	26 x 4,44	7 x 3,45	468,0	402,6	28,11	10,35	1 628,1	1 115,8	512,3	140 170	0,07054	0,07283	0,08694	995		
COOT	795,0	36 x 3,77	1 x 3,77	413,1	401,9	26,39	3,77	1 198,0	1 110,2	87,8	74 760	0,07152	0,07415	0,08825	975		
TERN	795,0	45 x 3,38	7 x 2,25	431,6	403,8	27,03	6,75	1 333,4	1 116,1	217,3	98 340	0,07119	0,07382	0,08793	970		
CONDOR	795,0	54 x 3,08	7 x 3,08	454,5	402,3	27,72	9,24	1 523,9	1 116,1	407,8	125 480	0,07054	0,07283	0,08694	975		
MALLARD	795,0	30 x 4,14	19 x 2,48	495,6	403,8	28,96	12,40	1 837,9	1 118,7	719,2	170 870	0,06988	0,07218	0,08596	1 005		
RUDDY	900,0	45 x 3,59	7 x 2,40	487,2	455,5	28,74	7,20	1 510,5	1 263,5	247,0	108 580	0,06234	0,06463	0,07743	1 050		
CANARY	900,0	54 x 3,28	7 x 3,28	515,4	456,3	29,52	9,84	1 724,8	1 263,5	461,3	141 950	0,06234	0,06463	0,07710	1 055		
CATBIRD	954,0	36 x 4,14	1 x 4,14	498,1	484,6	28,98	4,14	1 437,6	1 333,4	104,2	88 110	0,05971	0,06234	0,07415	1 095		
RAIL	954,0	45 x 3,70	7 x 2,47	517,3	483,8	29,61	7,41	1 599,8	1 339,4	260,4	115 250	0,05938	0,06201	0,07382	1 090		
CARDINAL	654,0	54 x 3,38	7 x 3,38	547,3	484,5	30,42	10,14	1 829,0	1 339,8	489,2	150 400	0,05906	0,06135	0,07316	1 095		
TANAGER	1033,5	36 x 4,30	1 x 4,30	537,3	522,8	30,10	4,30	1 556,6	1 443,5	113,1	92 230	0,05577	0,05873	0,06923	1 130		
ORTOLAN	1033,5	45 x 3,85	7 x 2,57	560,2	523,9	30,81	7,71	1 733,7	1 451,0	282,7	123 260	0,05479	0,05741	0,06824	1 150		
CURLUE	1033,5	54 x 3,52	7 x 3,52	593,6	525,5	31,68	10,56	1 980,8	1 451,0	529,8	162 860	0,05446	0,05677	0,06759	1 150		
BLUEJAY	1113,0	45 x 4,00	7 x 2,66	604,4	565,5	31,98	7,98	1 867,7	1 562,6	305,1	132 600	0,05085	0,05348	0,06365	1 205		
FINCH	1113,0	54 x 3,65	19 x 2,19	636,6	565,0	32,85	10,95	2 129,6	1 570,0	559,6	174 000	0,05085	0,05315	0,06332	1 205		
BUNTING	1192,5	45 x 4,14	7 x 2,76	647,7	605,8	33,12	8,28	2 000,1	1 674,2	325,9	142 400	0,04757	0,05020	0,05938	1 255		
GRACKLE	1192,5	54 x 3,77	19 x 2,27	679,7	602,8	33,97	11,35	2 281,4	1 681,7	599,8	186 450	0,04724	0,04954	0,05906	1 260		
SKYLARK	1272,0	36 x 4,78	1 x 4,78	664,0	646,0	33,46	4,78	1 916,8	1 776,9	139,9	117 480	0,04462	0,04757	0,05643	1 310		
BITTERN	1272,0	45 x 4,27	7 x 2,85	689,1	644,4	34,17	8,55	2 134,1	1 785,8	348,3	151 740	0,04462	0,04724	0,05610	1 310		
PHEASANT	1272,0	54 x 3,90	19 x 2,34	726,8	645,1	35,10	11,70	2 433,2	1 794,2	639,0	194 000	0,04429	0,04659	0,05545	1 310		

We reserve the right to modify, at any time, without any obligation and without prior notice, the specifications and other technical data in this document, which must be confirmed when ordering.



Code word	Size	Composition		Cross-section		Outer diameter		Cable weight		Rated strength		Electrical resistance (Ω/km)			Current carrying capacity A (I)
		Alum. (mm)	Steel (mm)	Total (mm ²)	Alum. (mm ²)	Total (mm)	Nucleo (mm)	Total Kg/Km	Alum. kg/km	Steel kg/km	(N)	d.c. 20°C	a.c. 25°C	a.c. 75°C	
DIPPER	1351,5	45 x 4,40	7 x 2,93	731,4	684,2	35,19	8,79	2 266,5	1 898,5	368,0	161 080	0,04199	0,04495	0,05282	1 360
MARTIN	1351,5	54 x 4,02	19 x 2,41	772,1	685,4	36,17	12,05	2 585,0	1 906,4	678,6	206 030	0,04167	0,04396	0,05217	1 365
BOBOLINK	1431,0	45 x 4,53	7 x 3,02	775,4	725,3	36,24	9,06	2 400,4	2 009,1	391,3	170 430	0,03970	0,04265	0,05020	1 410
PLOVER	1431,0	54 x 4,14	19 x 2,48	818,7	726,9	37,24	12,40	2 738,3	2 019,0	719,3	218 480	0,03937	0,04167	0,04954	1 415
NUTHATCH	1510,5	45 x 4,65	7 x 3,10	817,0	764,2	37,20	9,30	2 532,9	2 120,7	412,2	178 440	0,03740	0,04035	0,04757	1 455
PARROT	1510,5	54 x 4,25	19 x 2,55	863,1	766,1	38,25	12,75	2 890,1	2 131,1	759,0	230 050	0,03740	0,04003	0,04724	1 460
LAPWING	1590,0	45 x 4,78	7 x 3,18	863,1	807,5	38,22	9,54	2 666,8	2 232,3	434,5	187 780	0,03576	0,03871	0,04560	1 505
FALCON	1590,0	54 x 4,36	19 x 2,62	908,6	806,2	39,26	13,10	3 041,9	2 242,7	799,2	242 510	0,03543	0,03806	0,04495	1 510

Note 1 – With the following conditions: Ambient temperature = 25°C;

Conductors' temperature = 75°C;

Wind velocity = 0,6 m/s. Without solar radiation.

Note 2 – Outer layer stranding direction: Right-hand (Z).

APPLICATION

Conductor used as power ground wire for protection of aerial power lines of medium, high and extra high voltage. Indicated for aerial lines with long span lengths.

CONSTRUCTION CHARACTERISTICS

Conductors are made of one or several layers of aluminium alloy wires stranded in concentric layers around a galvanized steel core. The steel core can be impregnated with a protective grease. AACSR – "Aluminium Alloy Conductor Steel Reinforced"

GENERAL CHARACTERISTICS

Good resistance to corrosion

The ratio strength/weight is higher than standard ACSR cables

Ideal for extra-long spans with heavy load and for river crossings



ELECTRICAL AND DIMENSIONAL CHARACTERISTICS

CENELEC EN50182 standard

Characteristics of aluminium alloy conductors with galvanized steel core – Type AL3 / ST1A – Spain

Code number	Old code	Cross-section			N.° of wires			Nominal diameter		Diameter		Linear mass (kg/km)	Rated strength (kN)	Electrical resistance d.c. 20°C (Ω/km)
		Alum. (mm ²)	Steel (mm ²)	Total (mm ²)	Alum. (mm)	Steel (mm)	Alum. (mm)	Steel (mm)	Core (mm)	Cond. (mm)				
27-AL3/4-ST1A	DA 30	26,7	4,45	31,1	6	1	2,38	2,38	2,38	7,14	107,7	12,95	1,2356	
47-AL3/8-ST1A	DA 56	46,8	7,79	54,6	6	1	3,15	3,15	3,15	9,45	188,6	22,37	0,7054	
67-AL3/11-ST1A	DA 78	67,3	11,2	78,6	6	1	3,78	3,78	3,78	11,3	271,6	32,21	0,4898	
94-AL3/22-ST1A	DA 110	94,2	22,0	116,2	30	7	2,00	2,00	2,00	14,0	432,2	53,53	0,3530	
119-AL3/28-ST1A	DA 145	119,3	27,8	147,1	30	7	2,25	2,25	2,25	15,8	547,0	67,75	0,2789	
147-AL3/34-ST1A	DA 180	147,3	34,4	181,6	30	7	2,50	2,50	2,50	17,5	675,3	82,61	0,2259	
226-AL3/53-ST1A	DA 280	226,4	52,8	279,3	30	7	3,10	3,10	3,10	21,7	1 038,4	124,91	0,1469	

Note 1 – Outer layer stranding direction: Right-hand (Z).

CENELEC EN50182 standard

Characteristics of aluminium alloy conductors with galvanized steel core – Type AL3 / ST1A – Germany

Code number	Old code	Cross-section			N.° of wires			Nominal diameter		Diameter		Linear mass (kg/km)	Rated strength (kN)	Electrical resistance d.c. 20°C (Ω/km)	Final coefficient of thermal expansion (1/K)	Current carrying capacity A (1)
		Alum. (mm ²)	Steel (mm ²)	Total (mm ²)	Alum. (mm)	Steel (mm)	Alum. (mm)	Steel (mm)	Core (mm)	Cond. (mm)						
15-AL3/3-ST1A	16/2,5	15,3	2,54	17,8	6	1	1,80	1,80	1,80	5,40	61,6	7,48	2,1602	81 000	1,92E-05	100
24-AL3/4-ST1A	25/4	23,9	3,98	27,8	6	1	2,25	2,25	2,25	6,75	96,2	11,69	1,3825	81 000	1,92E-05	135
34-AL3/6-ST1A	35/6	34,4	5,73	40,1	6	1	2,70	2,70	2,70	8,10	138,6	16,66	0,9601	81 000	1,92E-05	165
44-AL3/32-ST1A	44/32	44,0	31,7	75,6	14	7	2,00	2,40	7,20	11,2	369,1	49,08	0,7566	110 000	1,50E-05	--
48-AL3/8-ST1A	50/8	48,3	8,04	56,3	6	1	3,20	3,20	3,20	9,60	194,7	23,08	0,6835	81 000	1,92E-05	200
51-AL3/30-ST1A	50/30	51,2	29,8	81,0	12	7	2,33	2,33	6,99	11,7	374,6	49,12	0,6496	107 000	1,53E-05	---
70-AL3/11-ST1A	70/12	69,9	11,4	81,3	26	7	1,85	1,44	4,32	11,7	282,0	33,96	0,4756	77 000	1,89E-05	270
94-AL3/15-ST1A	95/15	94,4	15,3	109,7	26	7	2,15	1,67	5,01	13,6	380,3	45,79	0,3521	77 000	1,89E-05	330
97-AL3/56-ST1A	95/55	96,5	56,3	152,8	12	7	3,20	3,20	9,60	16,0	706,5	90,40	0,3444	107 000	1,53E-05	---
106-AL3/76-ST1A	105/75	105,7	75,5	181,2	14	19	3,10	2,25	11,3	17,5	885,0	119,56	0,3155	110 000	1,50E-05	---

We reserve the right to modify, at any time, without any obligation and without prior notice, the specifications and other technical data in this document, which must be confirmed when ordering.



Code number	Old code	Cross-section			N.° of wires		Nominal diameter		Diameter		Linear mass strength (kg/km)	Rated strength (kN)	Electrical resistance d.c. 20°C (Ω/km)	Final modulus of elasticity (N/mm ²)	Final coefficient of thermal expansion (1/K)	Current carrying capacity A (I)
		Alum. (mm ²)	Steel (mm ²)	Total (mm ²)	Alum.	Steel	Alum.	Steel	Core	Cond.						
122-AL3/20-ST1A	120/20	121,6	19,8	141,4	26	7	2,44	1,90	5,70	15,5	490,6	59,09	0,2734	77 000	1,89E-05	385
122-AL3/71-ST1A	120/70	122,1	71,3	193,4	12	7	3,60	3,60	10,8	18,0	894,2	114,41	0,2721	107 000	1,53E-05	--
128-AL3/30-ST1A	125/30	127,9	29,8	157,8	30	7	2,33	2,33	6,99	16,3	586,6	71,76	0,2601	82 000	1,78E-05	400
149-AL3/24-ST1A	150/25	148,9	24,2	173,1	26	7	2,70	2,10	6,30	17,1	600,3	72,28	0,2233	77 000	1,89E-05	445
172-AL3/40-ST1A	170/40	171,8	40,1	211,8	30	7	2,70	2,70	8,10	18,9	787,7	96,36	0,1937	82 000	1,78E-05	490
184-AL3/30-ST1A	185/30	183,8	29,8	213,6	26	7	3,00	2,33	6,99	19,0	740,4	88,24	0,1809	77 000	1,89E-05	505
209-AL3/34-ST1A	210/35	209,1	34,1	243,2	26	7	3,20	2,49	7,47	20,3	843,5	100,54	0,1590	77 000	1,89E-05	555
212-AL3/49-ST1A	210/50	212,1	49,5	261,5	30	7	3,00	3,00	9,00	21,0	972,5	118,96	0,1569	82 000	1,78E-05	575
231-AL3/30-ST1A	230/30	230,9	29,8	260,8	24	7	3,50	2,33	6,99	21,0	870,1	102,14	0,1439	74 000	1,96E-05	595
243-AL3/39-ST1A	240/40	243,1	39,5	282,5	26	7	3,45	2,68	8,04	21,8	979,4	116,72	0,1368	77 000	1,89E-05	605
264-AL3/34-ST1A	265/35	263,7	34,1	297,7	24	7	3,74	2,49	7,47	22,4	993,6	116,64	0,1260	74 000	1,96E-05	640
304-AL3/49-ST1A	300/50	304,3	49,5	353,7	26	7	3,86	3,00	9,00	24,4	1 226,4	146,16	0,1092	77 000	1,89E-05	700
305-AL3/39-ST1A	305/40	304,6	38,5	344,1	54	7	2,68	2,68	8,04	24,1	1 150,3	134,88	0,1093	70 000	1,93E-05	700
339-AL3/30-ST1A	340/30	339,3	29,8	369,1	48	7	3,00	2,33	6,99	25,0	1 170,2	134,12	0,0980	62 000	2,05E-05	740
382-AL3/49-ST1A	380/50	381,7	49,5	431,2	54	7	3,00	3,00	9,00	27,0	1 441,4	169,01	0,0872	70 000	1,93E-05	790
386-AL3/34-ST1A	385/35	386,0	34,1	420,1	48	7	3,20	2,49	7,47	26,7	1 332,4	152,74	0,0862	62 000	2,05E-05	800
434-AL3/56-ST1A	435/55	434,3	56,3	490,6	54	7	3,20	3,20	9,60	28,8	1 640,0	190,04	0,0766	70 000	1,93E-05	845
449-AL3/39-ST1A	450/40	448,7	39,5	488,2	48	7	3,45	2,68	8,04	28,7	1 547,7	177,39	0,0741	62 000	2,05E-05	865
490-AL3/64-ST1A	490/65	490,3	63,6	553,8	54	7	3,40	3,40	10,2	30,6	1 851,4	215,54	0,0679	70 000	1,93E-05	905
550-AL3/71-ST1A	550/70	549,7	71,3	620,9	54	7	3,60	3,60	10,8	32,4	2 075,6	240,52	0,0605	70 000	1,93E-05	960
562-AL3/49-ST1A	560/50	561,7	49,5	611,2	48	7	3,86	3,00	9,00	32,2	1 937,8	222,11	0,0592	62 000	2,05E-05	980
679-AL3/86-ST1A	680/85	678,6	86,0	764,5	54	19	4,00	2,40	12,0	36,0	2 547,6	298,17	0,0490	68 000	1,94E-05	1 080

Note 1 – (1) Guideline values of current carrying capacity are valid up to a frequency of 60 Hz, assuming a wind velocity of 0,6 m/s, the effect of solar radiation for Germany, an initial ambient temperature of 35° C and a conductor temperature of 80° C. For special applications, when there is no air turbulence, the values should be reduced by 30 %.

Note 2 – Values of final modulus of elasticity and coefficient of linear expansion for the conductor sizes listed in the Table are used in Germany. Values for other conductor constructions may be calculated using the method given in IEC 61597.

Note 3 – Outer layer stranding direction: Right-hand (Z).



We reserve the right to modify, at any time, without any obligation and without prior notice, the specifications and other technical data in this document, which must be confirmed when ordering.



CENELEC EN50182 standard

Characteristics of aluminium alloy conductors with galvanized steel core - Type AL4 / ST6C - France

Code number	Old code	Cross-section		N.° of wires		Nominal diam.		Diameter		Linear mass strength (kg/km)	Rated strength (kN)	Electrical resistance d.c. 20°C (Ω/km)	Final modulus of elasticity (N/mm ²)	Final coefficient of thermal expansion (1/K)	Stranding direction	
		Alum. (mm ²)	Steel (mm ²)	Total (mm ²)	Alum.	Steel	Steel Alum.	Steel core	Steel Cond.							
28-AL4/9-ST6C	PHLOX 37,7	28,3	9,4	37,7	9	3	2,00	2,00	4,30	8,30	151,4	22,86	1,1750	93 000	1,70E-05	Z
38-AL4/22-ST6C	PHLOX 59,7	37,7	22,0	59,7	12	7	2,00	2,00	6,00	10,0	276,0	44,14	0,8835	108 000	1,53E-05	S
48-AL4/28ST6C	PHLOX 75,5	47,7	27,8	75,5	12	7	2,25	2,25	6,75	11,3	349,3	55,86	0,6981	108 000	1,53E-05	S
52-AL4/42ST6C	PHLOX 94,1	52,0	42,1	94,1	15	19	2,10	1,68	8,40	12,6	474,2	77,96	0,6435	112 000	1,47E-05	S
57-AL4/60-ST6C	PHLOX 116,2	56,5	59,7	116,2	18	19	2,00	2,00	10,0	14,0	625,0	104,93	0,5921	124 000	1,42E-05	S
72-AL4/76-ST6C	PHLOX 147,1	71,6	75,5	147,1	18	19	2,25	2,25	11,3	15,8	791,0	132,80	0,4678	124 000	1,42E-05	S
119-AL4/28ST6C	PHLOX 147,1	119,3	27,8	147,1	30	7	2,25	2,25	6,75	15,8	547,0	79,12	0,2795	84 000	1,81E-05	S
88-AL4/93-ST6C	PHLOX 181,6	88,4	93,3	181,6	18	19	2,50	2,50	12,5	17,5	976,6	160,22	0,3789	124 000	1,42E-05	S
147-AL4/34-ST6C	PHLOX 181,6	147,3	34,4	181,6	30	7	2,50	2,50	7,50	17,5	675,3	96,31	0,2264	84 000	1,81E-05	S
111-AL4/117-ST6C	PHLOX 228	110,8	117,0	227,8	18	19	2,80	2,80	14,0	19,6	1 225,0	200,98	0,3021	124 000	1,42E-05	S
185-AL4/43-ST6C	PHLOX 228	184,7	43,1	227,8	30	7	2,80	2,80	8,40	19,6	847,1	120,81	0,1805	84 000	1,81E-05	S
140-AL4/148-ST6C	PHLOX 288	140,3	148,1	288,3	18	19	3,15	3,15	15,8	22,1	1 550,4	249,93	0,2387	124 000	1,42E-05	S
234-AL4/55-ST6C	PHLOX 288	233,8	54,6	288,3	30	7	3,15	3,15	9,45	22,1	1 072,1	151,26	0,1426	84 000	1,80E-05	S
206-AL4/93-ST6C	PHLOX 299	206,2	93,3	299,4	42	19	2,50	2,50	12,5	22,5	1 302,8	198,51	0,1622	96 500	1,63E-05	S
148-AL4/228-ST6C	PHLOX 376	147,8	227,8	375,6	24	37	2,80	2,80	19,6	25,2	2 202,4	369,27	0,2270	130 000	1,35E-05	S
326-AL4/86-ST6C	PHLOX 412	325,7	86,0	411,7	32	19	3,60	2,40	12,0	26,4	1 575,1	223,80	0,1025	82 000	1,78E-05	S
508-AL4/105-ST6C	PHLOX 612	507,8	104,8	612,6	66	19	3,13	2,65	13,3	32,0	2 225,0	312,81	0,0657	77 500	1,86E-05	S
717-AL4/148-ST6C	PHLOX 865	717,3	148,1	865,4	66	19	3,72	3,15	15,8	38,1	3 143,2	430,29	0,0465	77 500	1,85E-05	S
957-AL4/228-ST6C	Polygonum 1 185	956,7	227,8	1 184	54	37	2,80	2,80	19,6	42,0	4 430,7	632,15	0,0349	77 500	1,81E-05	S

Note 1 - Values of final modulus of elasticity and coefficient of linear expansion for the conductor sizes listed in the Table are used in France. Values for other conductor constructions may be calculated using the method given in IEC 61597.

BARE OVERHEAD CONDUCTORS Aluminium alloy conductor Aluminium clad steel reinforced (LARL)**APPLICATION**

Power ground wire for protection of aerial power lines of medium, high and extra high voltage. Specially recommended for coastal areas (atmosphere with high levels of salinity).

CONSTRUCTION CHARACTERISTICS

Conductors are made of one or several layers of aluminium wires stranded in concentric layers around aluminium clad steel wires of the reinforcing core.
ACSR/AW – Aluminium Conductor Steel Reinforced (Alumoweld).

GENERAL CHARACTERISTICS

Resistance to corrosion higher than ACSR and AACSR cables

Good ratio for strength/weight, allowing the use in long span lengths



ELECTRICAL AND DIMENSIONAL CHARACTERISTICS

CENELEC EN50182:2001 standard

Characteristics of Aluminium conductors aluminium clad Steel reinforced (LARL) – Spain

Old code	Cross-section		CU equiv.	Outer diameter		Composition		Rated strength (daN)	Electrical resistance d.c. 20°C (Ω/km)	Linear mass kg/km		Final modulus of elasticity N/mm ²	Coefficient of dilatation lineal x 10 ⁻⁶ °C		
	Alum. (mm ²)	ARL ACS (l)		Total (mm ²)	Core	Total	Aluminium N.º Diam. (mm)			ARL N.º Diam. (mm)	Alum. (mm ²)			ARL (kg/km)	Total (kg/km)
LARL 30	26,7	4,4	31,1	17,5	2,38	7,14	6	2,38	1 020	1,0175	73,2	29,3	102,5	75 000	19,3
LARL 56	46,8	7,8	54,6	30	3,15	9,45	6	3,15	1 720	0,5808	128,3	51,4	179,7	75 000	19,3
LARL 78	67,4	11,2	78,6	44	3,78	11,34	6	3,78	2 300	0,4033	185	74	259	75 000	19,3
LARL125 PENGUIN	107,2	17,9	125,1	71	4,77	14,31	6	4,77	3 560	0,2568	294	118	412	75 000	19,3
LARL 180	147,3	34,3	181,6	97	7,50	17,50	30	2,50	6 630	0,1818	407	227	634	75 000	18
LARL 280 HAWK	241,7	39,4	281,1	157	8,04	21,80	26	3,44	8 720	0,1131	667	262	929	72 000	19,1
LARL 380 GULL	337,3	43,7	381,0	217	8,46	25,38	54	2,82	10 870	0,0820	932	290	1222	66 000	19,5
LARL 455 CONDOR	402,3	52,2	454,5	259	9,24	27,72	54	3,08	12 910	0,0688	1 112	343	1457	66 000	19,5
LARL 510 RAIL	483,4	33,4	516,8	308	7,39	29,59	45	3,70	11 740	0,0585	1 339	221	1560	63 000	21,1
LARL 545 CARDINAL	484,5	62,8	547,3	312	10,14	30,42	54	3,38	15 400	0,0571	1 339	416	1755	66 000	19,5
LARL 600 BLUEJAY	563,9	39,1	603,0	359	8,00	31,98	45	4,00	13 700	0,0502	1 563	258	1821	63 000	21,1
LARL 820 PLOVER	725,1	91,9	817,0	468	12,41	37,21	54	4,14	22 620	0,0385	2 019	609	2628	63 000	19,6

(1) ARL Aluminium covered steel.

(Note 2 – Outer layer stranding direction: Right-hand (Z).

ASTM B-549 standard

Characteristics of Aluminium conductors aluminium clad Steel reinforced (ACSR/AW) – Countries with North American influence

Code word	Alum. size (AWG/kcmil)	Alum. Cross-section (mm ²)	Total cross-section (mm ²)	Outer diameter (mm)	N.º of wires Al/AW	Wire diameter		Rated strength (KgF)	Linear mass			Electrical resistance (Ω/Km)			
						Alum. (mm)			Total (Kg/km)	Alum. (Kg/km)	ARL (Kg/km)	d.c. 20°C	a.c.- 60HZ 25°C	75°C	
						Alum. (mm)	ARL (l)								ARL (Kg/km)
SWAN / AW	4	22,03	24,67	6,35	6/1	2,118	2,118	807	81,3	58,0	23,2	1,285	1,311	1,438	1,565
SWANATE / AW	4	22,48	26,50	6,53	7/1	1,961	2,614	1 034	93,3	58,0	35,3	1,251	1,276	1,399	1,523
SPARROW / AW	2	35,05	39,80	8,03	6/1	2,672	2,672	1 252	129,2	92,3	36,9	0,8078	0,8240	0,9035	0,9831
SPARATE / AW	2	35,79	42,20	8,26	7/1	2,474	3,299	1 592	148,7	92,4	56,3	0,7861	0,8016	0,8793	0,9570
ROBIN / AW	1	44,25	49,56	9,02	6/1	3,002	3,002	1 567	163,1	116,5	46,6	0,6398	0,6525	0,7159	0,7786

BARE OVERHEAD CONDUCTORS

Code word	Alum. size (AWG/Kcmil)	Alum. Cross-section (mm ²)	Total cross-section (mm ²)	Outer diameter (mm)	N° of wires Al/AW	Wire diameter		Rated strength (KgF)	Linear mass			Electrical resistance (Ω/Km)			
						Alum. (mm)	ARL (l) (mm)		Total (Kg/km)	Alum. (Kg/km)	ARL (Kg/km)	d.c. 20°C	a.c.- 60HZ 25°C	75°C	
RAVEN / AW	1/0	55,79	62,46	10,11	6/1	3,371	3,371	1 927	205,7	146,9	58,8	0,5076	0,5177	0,5678	0,6180
QUAIL / AW	2/0	70,34	78,78	11,35	6/1	3,785	3,785	2 331	259,3	185,1	74,1	0,4012	0,4106	0,4504	0,4902
PIGEON / AW	3/0	88,53	99,17	12,75	6/1	4,247	4,247	2 859	326,5	232,2	93,3	0,3198	0,3264	0,3581	0,3897
PENGUIN / AW	4/0	111,7	125,1	14,30	6/1	4,770	4,770	3 486	412	294,2	177,7	0,2535	0,2590	0,2841	0,3091
WAXWING / AW	266,8	137,0	142,6	15,47	18/1	3,091	3,091	3 094	421,9	372,5	49,4	0,2088	0,2135	0,2341	0,2551
PARTRIDGE / AW	266,8	140,7	157,2	16,31	26/7	2,002	2,002	4 899	520,3	374,6	145,7	0,2024	0,2068	0,2271	0,2474
MERLIN / AW	336,4	172,8	179,9	17,37	18/1	3,472	3,472	3 873	532,4	470,0	62,4	0,1655	0,1694	0,1860	0,2026
LINNET / AW	336,4	177,6	198,4	18,31	26/7	2,248	2,248	6 128	656,5	472,7	183,8	0,1607	0,1643	0,1804	0,1965
ORTOLE / AW	336,4	170,6	210,3	18,82	30/7	2,691	2,691	7 598	736,9	473,4	263,4	0,1573	0,1608	0,1765	0,1923
CHICKADEE / AW	397,5	204,2	212,6	18,87	18/1	3,774	3,774	4 435	629	555,3	73,7	0,1400	0,1435	0,1576	0,1716
BRANT / AW	397,5	207,9	227,6	19,61	24/7	2,179	2,179	6 378	730,8	558,1	172,6	0,1373	0,1406	0,1544	0,1681
IBIS / AW	397,5	209,5	234,0	19,89	26/7	2,441	2,441	7 158	774,4	557,7	216,7	0,1360	0,1391	0,1527	0,1664
LARK / AW	397,5	213,1	248,4	20,47	30/7	2,924	2,924	8 904	870,5	559,3	311,2	0,1332	0,1362	0,1496	0,1629
PELIKAN / AW	477,0	245,1	255,2	20,68	18/1	4,135	4,135	5 198	754,9	666,5	88,4	0,1167	0,1191	0,1308	0,1425
FLICKER / AW	477,0	249,6	273,1	21,43	24/7	2,388	2,388	7 575	877,2	669,9	207,3	0,1144	0,1173	0,1288	0,1402
HAWK / AW	477,0	251,7	281,3	21,79	26/7	2,677	2,677	8 609	930,8	670,2	260,6	0,1133	0,1161	0,1274	0,1388
HEN / AW	477,0	255,8	298,1	22,43	30/7	3,203	3,203	10 614	1044	671,4	373,4	0,1110	0,1137	0,1247	0,1358
OSPREY / AW	556,5	285,8	297,6	22,33	18/1	4,465	4,465	6 010	880,3	771,2	103,1	0,1001	0,1030	0,1130	0,1230
PARAKEET / AW	556,5	291,2	318,7	23,22	24/7	2,578	2,578	8 741	1 023	781,5	241,7	0,09807	0,1007	0,1105	0,1203
DOVE / AW	556,5	293,5	328,0	23,55	26/7	2,891	2,891	9 943	1 085	781,2	303,9	0,09703	0,09961	0,1093	0,1190
EAGLE / AW	556,5	298,5	347,8	24,21	30/7	3,459	3,459	12 161	1 219	783,3	435,6	0,09512	0,09756	0,1070	0,1165
PEACOCK / AW	605,0	316,6	346,5	24,21	24/7	2,691	2,691	9 512	1 112	849,6	263,1	0,09019	0,09278	0,1018	0,1108
SQUAB / AW	605,0	318,9	356,3	24,54	26/7	3,012	3,012	10 700	1 179	848,9	330,0	0,09097	0,09181	0,1007	0,1096
TEAL / AW	605,0	324,0	376,4	25,25	30/19	2,164	2,164	12 905	1 314	851,3	463,2	0,08767	0,08998	0,09874	0,1074
KINGBIRD / AW	636,0	326,8	340,3	23,88	18/1	4,775	4,775	6 813	1 006	888,8	118,0	0,08750	0,09035	0,09905	0,1078
ROOK / AW	636,0	332,8	364,1	24,82	24/7	2,756	2,756	9 988	1 169	893,0	276,2	0,08583	0,08836	0,09688	0,1055
GROSBEAK / AW	636,0	335,4	374,7	25,15	26/7	3,089	3,089	11 254	1 240	892,8	346,9	0,08491	0,08737	0,09582	0,1043
EGRET / AW	636,0	340,7	395,8	25,88	30/19	2,220	2,220	13 576	1 382	895,0	487,4	0,08337	0,08563	0,09396	0,1023
FLAMINGO / AW	666,6	348,9	381,8	24,40	24/7	2,822	2,822	10 474	1 226	936,3	289,6	0,08186	0,08432	0,09246	0,1007



We reserve the right to modify, at any time, without any obligation and without prior notice, the specifications and other technical data in this document, which must be confirmed when ordering.



Code word	Alum. size (AWG/Kcmil)	Alum. Cross-section (mm ²)	Total cross-section (mm ²)	Outer diameter (mm)	N.° of wires Al/AW	Wire diameter		Rated strength (KgF)	Linear mass			Electrical resistance (Ω/Km)			
						Alum. (mm)	ARL (1) (mm)		Total (Kg/km)	Alum. (Kg/km)	ARL (Kg/km)	d.c. 20°C	a.c.- 60HZ		
													25°C	50°C	75°C
GANNET / AW	666,6	351,5	392,7	25,76	26/7	4,067	3,162	11 794	1 299	935,7	363,6	0,08104	0,08339	0,09147	0,09955
STARLING / AW	715,5	377,4	421,6	26,70	26/7	4,214	3,277	12 465	1 395	1 005	390,4	0,07546	0,07780	0,08532	0,09284
REDWING / AW	715,5	383,0	445,0	27,46	30/19	3,922	2,352	15 146	1 554	1 006	547,7	0,07415	0,07631	0,08370	0,09110
TERN / AW	795,0	409,7	430,6	27,00	45/7	3,376	2,250	9 730	1 300	1 116	184,1	0,07005	0,07264	0,07960	0,08656
CUCKOO / AW	795,0	415,9	455,1	27,74	24/7	4,623	3,081	12 483	1 461	1 116	345,1	0,06867	0,07103	0,07786	0,08470
CONDOR / AW	795,0	416,3	455,6	27,76	54/7	3,084	3,084	12 624	1 463	1 117	345,4	0,06861	0,07096	0,07774	0,08457
DRAKE / AW	795,0	402,6	468,6	28,14	26/7	4,442	3,454	13 717	1 551	1 116	434,6	0,06792	0,07016	0,07693	0,08364
MALLARD / AW	795,0	425,9	494,8	28,96	30/19	4,135	2,482	16 833	1 728	1 119	608,7	0,06670	0,06879	0,75389	0,08203
RUDDY / AW	900,0	463,9	487,4	28,73	45/7	3,592	2,395	10 873	1 472	1 263	208,7	0,06188	0,06413	0,07022	0,07643
CANARY / AW	900,0	470,9	515,2	29,51	54/7	3,279	3,279	14 080	1 654	1 264	389,9	0,06067	0,06301	0,06898	0,07500
RAIL / AW	954,0	491,8	516,9	29,59	45/7	3,698	2,466	11 526	1 561	1 339	221,8	0,05837	0,06097	0,06674	0,07252
CARDINAL / AW	954,0	500,0	546,0	30,38	54/7	3,376	3,376	14 919	1 753	1 339	413,7	0,05722	0,05956	0,06519	0,07090
ORTOLAN / AW	1 033,5	533,1	560,4	30,81	45/7	3,851	2,568	12 329	1 692	1 453	239,6	0,05384	0,05647	0,06175	0,06705
CURLEW / AW	1 033,5	541,2	592,1	31,65	54/7	3,515	3,515	15 949	1 901	1 453	448,0	0,05279	0,05511	0,06052	0,06550
BLUEJAY / AW	1 113,5	564,1	603,3	31,98	45/7	3,995	2,664	13 277	1 822	1 563	260,0	0,05269	0,05267	0,05757	0,06251
FINCH / AW	1 113,5	582,2	635,8	32,84	54/19	3,647	2,189	17 028	2 045	1 570	474,8	0,04931	0,05165	0,05649	0,06134
BUNTING / AW	1 192,5	614,7	645,8	33,07	45/7	4,135	2,756	14 211	1 951	1 674	276,8	0,04669	0,04940	0,05395	0,05852
GRACKLE / AW	1 192,5	623,3	680,7	33,86	54/19	3,774	2,266	18 235	2 189	1 682	507,5	0,04603	0,04841	0,05291	0,05744
BITTERN / AW	1 272,0	655,7	689,1	34,16	45/7	4,270	2,847	15 159	2 081	1 786	294,7	0,04380	0,04655	0,05080	0,05507
PHEASANT / AW	1 272,0	665,3	726,5	35,10	54/19	3,899	2,339	19 246	2 337	1 795	541,7	0,04315	0,04556	0,04977	0,05399
DIPPER / AW	1 351,5	696,8	731,7	35,20	45/7	4,402	2,924	16 062	2 209	1 898	311,1	0,04121	0,04403	0,04801	0,05202
MARTIN / AW	1 351,5	706,4	771,7	36,17	54/19	4,018	2,410	20 435	2 481	1 907	574,5	0,04062	0,04308	0,04702	0,05099
BOBOLINK / AW	1 431,0	737,3	774,9	36,25	45/7	4,529	3,020	17 055	2 340	2 008	331,9	0,03891	0,04180	0,04555	0,04932
PLOVER / AW	1 431,0	748,5	817,5	37,21	54/19	4,135	2,482	21 650	2 628	2 020	608,7	0,03835	0,04086	0,04457	0,04830
NUTHATCH / AW	1 510,5	778,4	818,1	37,24	45/7	4,653	3,101	17 994	2 471	2 121	349,8	0,03688	0,03981	0,04334	0,04690
PARROT / AW	1 510,5	792,0	864,6	38,25	54/19	4,255	2,550	22 893	2 780	2 137	642,9	0,03626	0,03879	0,04228	0,04579
LAPWING / AW	1 590,0	818,4	860,1	38,15	45/7	4,770	3,180	18 920	2 596	2 228	367,6	0,03507	0,03810	0,04144	0,04481
FALCON / AW	1 590,0	831,6	907,8	39,24	54/19	4,359	2,616	24 059	2 920	2 243	677,2	0,03452	0,03712	0,04043	0,04377

Note 1 - Outer layer stranding direction: Right-hand (Z).

APPLICATION

Power ground wires for protection of aerial power lines of medium, high and extra high voltage. Specially recommended for aerial lines with large spans and in hazardous environments (contaminated or corrosive).

CONSTRUCTION CHARACTERISTICS

Conductors are made of one or several layers of bare aluminium wires stranded in concentric layers around an aluminium alloy core. To bring the cable to specific applications, it is possible to vary the relative proportion of the cross-sectional area of aluminium and aluminium alloy.

ACAR – "Aluminium Conductor Alloy Reinforced"

GENERAL CHARACTERISTICS

Good resistance to corrosion.

Good ratio for strength/weight, allowing the use in long span lengths.

ELECTRICAL AND DIMENSIONAL CHARACTERISTICS

ASTM B-524 standard

Characteristics of aluminium conductors aluminium alloy reinforced.

Size AWG- -MCM	Cross- -section mm ²	Composition		Outer diam. mm	Linear mass Kg/km	Rated strength N	Electrical resist. (Ω/km)			Current carrying capacity A (1)
		Aluminium	Alloy				d.c. 20°C	a.c. 25°C	a.c. 75°C	
30,6	15,52	4 x 1,68	3 x 1,68	5,04	42,7	3 670	1,9794	2,0166	2,3916	110
4	21,12	4 x 1,96	3 x 1,96	5,88	58,3	4 970	1,4506	1,4784	1,7534	140
48,7	24,71	4 x 2,12	3 x 2,12	6,36	68,0	5 760	1,2429	1,2667	1,5023	153
2	33,54	4 x 2,47	3 x 2,47	7,41	92,7	7 790	0,9113	0,9288	1,1015	190
77,5	39,19	4 x 2,67	3 x 2,67	8,01	108,2	8 940	0,7811	0,7962	0,9441	205
1/0	5,52	4 x 3,12	3 x 3,12	9,36	147,5	12 000	0,5733	0,5844	0,6930	253
123,3	62,44	4 x 3,37	3 x 3,37	10,11	172,2	13 650	0,4909	0,5005	0,5935	280
2/0	67,35	4 x 3,50	3 x 3,50	10,50	185,9	14 700	0,4546	0,4636	0,5497	290
155,4	78,55	4 x 3,78	3 x 3,78	11,34	217,1	17 100	0,3894	0,3971	0,4709	325
3/0	84,91	4 x 3,93	3 x 3,93	11,79	234,4	18 300	0,3607	0,3680	0,4363	335
195,7	99,30	4 x 4,25	3 x 4,25	12,75	273,4	21 300	0,3092	0,3156	0,3741	380
4/0	107,4	4 x 4,42	3 x 4,42	13,26	295,5	23 000	0,2859	0,2917	0,3459	400
246,9	125,1	4 x 4,77	3 x 4,77	14,31	345,0	26 900	0,2451	0,2503	0,2967	435
250	126,4	15 x 2,91	4 x 2,91	14,55	349,3	24 400	0,2345	0,2397	0,2854	400
250	126,4	12 x 2,91	7 x 2,91	14,55	349,3	27 600	0,2399	0,2450	0,2909	435
300	151,9	15 x 3,19	4 x 3,19	15,95	419,1	28 900	0,1952	0,1997	0,2379	500
300	151,9	12 x 3,19	7 x 3,19	15,95	419,1	32 800	0,1998	0,2042	0,2423	500
350	177,6	15 x 3,45	4 x 3,45	17,25	489,0	33 200	0,1676	0,1715	0,2042	555
350	177,6	12 x 3,45	7 x 3,45	17,25	489,0	37 400	0,1714	0,1754	0,2081	550
400	203,2	15 x 3,69	4 x 3,69	18,45	558,8	37 500	0,1465	0,1502	0,1787	610
400	203,2	12 x 3,69	7 x 3,69	18,45	558,8	42 350	0,1499	0,1536	0,1821	605



Size AWG-MCM	Cross- -section mm ²	Composition		Outer diam. mm	Linear mass Kg/km	Rated strength kN	Electrical resistance (Ω/km)			Current carrying capacity A (1)
		Aluminium	Alloy				d.c. 20°C	a.c. 25°C	a.c. 75°C	
450	228,1	15 x 3,91	4 x 3,91	19,55	626,8	41 600	0,1302	0,1337	0,1590	650
450	228,1	12 x 3,91	7 x 3,91	19,55	626,8	47 200	0,1333	0,1367	0,1620	645
500	253,3	15 x 4,12	4 x 4,12	20,60	698,5	46 200	0,1173	0,1206	0,1433	690
500	253,3	12 x 4,12	7 x 4,12	20,60	698,5	52 400	0,1200	0,1232	0,1460	685
500	252,9	33 x 2,95	4 x 2,95	20,65	698,5	44 400	0,1156	0,1189	0,1417	700
500	252,9	30 x 2,95	7 x 2,95	20,65	698,5	48 000	0,1170	0,1203	0,1430	690
500	252,9	24 x 2,95	13 x 2,95	20,65	698,5	52 900	0,1198	0,1230	0,1458	685
500	252,9	18 x 2,95	19 x 2,95	20,65	698,5	58 800	0,1227	0,1259	0,1487	680
550	278,5	15 x 4,32	4 x 4,32	21,60	768,3	50 800	0,1066	0,1097	0,1304	740
550	278,5	12 x 4,32	7 x 4,32	21,60	768,3	57 600	0,1091	0,1122	0,1329	730
550	279,3	33 x 3,10	4 x 3,10	21,70	768,3	48 100	0,1051	0,1083	0,1290	750
550	279,3	30 x 3,10	7 x 3,10	21,70	768,3	52 100	0,1063	0,1094	0,1302	740
550	279,3	24 x 3,10	13 x 3,10	21,70	768,3	57 600	0,1088	0,1120	0,1326	735
550	279,3	18 x 3,10	19 x 3,10	21,70	768,3	64 300	0,1115	0,1146	0,1352	730
600	303,5	15 x 4,51	4 x 4,51	22,55	838,1	55 400	0,09770	0,10075	0,11972	780
600	303,5	12 x 4,51	7 x 4,51	22,55	838,1	62 900	0,09997	0,10305	0,12195	775
600	303,2	33 x 3,23	4 x 3,23	22,61	838,1	52 500	0,09636	0,09944	0,11840	790
600	303,2	30 x 3,23	7 x 3,23	22,61	838,1	56 950	0,09747	0,10056	0,11945	785
600	303,2	24 x 3,23	13 x 3,23	22,61	838,1	62 750	0,09977	0,10285	0,12175	775
600	303,2	18 x 3,23	19 x 3,23	22,61	838,1	70 000	0,10220	0,10522	0,12411	765
650	330,0	33 x 3,37	4 x 3,37	23,59	908,1	56 950	0,08894	0,09199	0,10945	835
650	330,0	30 x 3,37	7 x 3,37	23,59	908,1	61 400	0,08996	0,09298	0,11043	830
650	330,0	24 x 3,37	13 x 3,37	23,59	908,1	68 100	0,09209	0,09508	0,11257	820
650	330,0	18 x 3,37	19 x 3,37	23,59	908,1	76 100	0,09436	0,09734	0,11480	810
700	354,0	33 x 3,49	4 x 3,49	24,43	977,9	60 500	0,08258	0,08560	0,10180	875
700	354,0	30 x 3,49	7 x 3,49	24,43	977,9	65 400	0,08353	0,08652	0,10266	870
700	354,0	24 x 3,49	13 x 3,49	24,43	977,9	76 500	0,08553	0,08852	0,10466	860
700	354,0	18 x 3,49	19 x 3,49	24,43	977,9	79 650	0,08760	0,09049	0,10673	850
750	380,8	33 x 3,62	4 x 3,62	25,34	1 047,7	64 100	0,07700	0,07992	0,09501	920
750	380,8	30 x 3,62	7 x 3,62	25,34	1 047,7	69 400	0,07789	0,08087	0,09590	910
750	380,8	24 x 3,62	13 x 3,62	25,34	1 047,7	76 100	0,07976	0,08264	0,09777	900
750	380,8	18 x 3,62	19 x 3,62	25,34	1 047,7	84 550	0,08169	0,08458	0,09970	890
800	404,3	33 x 3,62	4 x 3,73	26,11	1 117,6	68 100	0,07224	0,07520	0,08930	955
800	404,3	30 x 3,62	7 x 3,73	26,11	1 117,6	73 850	0,07310	0,07608	0,09019	945
800	404,3	24 x 3,62	13 x 3,73	26,11	1 117,6	81 000	0,07484	0,07782	0,09186	935
800	404,3	18 x 3,62	19 x 3,73	26,11	1 117,6	90 300	0,07664	0,07956	0,09367	925
850	430,7	33 x 3,73	4 x 3,85	26,95	1 187,4	71 200	0,06795	0,07087	0,08415	995
850	430,7	30 x 3,73	7 x 3,85	26,95	1 187,4	77 400	0,06873	0,07165	0,08497	985
850	430,7	24 x 3,73	13 x 3,85	26,95	1 187,4	85 450	0,07034	0,07326	0,08652	975
850	430,7	18 x 3,73	19 x 3,85	26,95	1 187,4	95 200	0,07208	0,07497	0,08825	965
900	455,7	33 x 3,85	4 x 3,96	27,72	1 257,3	75 650	0,06414	0,06713	0,07963	1 030
900	455,7	30 x 3,85	7 x 3,96	27,72	1 257,3	81 900	0,06490	0,06788	0,08035	1 020

Size AWG-MCM	Cross- -section mm ²	Composition		Outer diam. mm	Linear mass Kg/km	Rated strength kN	Electrical resistance (Ω/km)			Current carrying capacity A (1)
		Aluminium	Alloy				d.c. 20°C	a.c. 25°C	a.c. 75°C	
1 300	659,4	54 x 3,63	7 x 3,71	33,39	1 816	116 700	0,04446	0,04780	0,05623	1 285
1 300	659,4	48 x 3,63	13 x 3,71	33,39	1 816	119 300	0,04511	0,04843	0,05686	1 270
1 300	659,4	42 x 3,63	19 x 3,71	33,39	1 816	128 600	0,04573	0,04905	0,05741	1 265
1 300	659,4	33 x 3,63	28 x 3,71	33,39	1 816	138 800	0,04675	0,04997	0,05843	1 260
1 400	710,1	54 x 3,85	7 x 3,85	34,65	1 955	117 900	0,04131	0,04475	0,05259	1 350
1 400	710,1	48 x 3,85	13 x 3,85	34,65	1 955	126 400	0,04190	0,04531	0,05315	1 335
1 400	710,1	42 x 3,85	19 x 3,85	34,65	1 955	137 100	0,04249	0,04587	0,05371	1 330
1 400	710,1	33 x 3,85	28 x 3,85	34,65	1 955	148 200	0,04341	0,04675	0,05449	1 325
1 500	758,9	54 x 3,98	7 x 3,98	35,82	2 095	126 400	0,03855	0,04206	0,04934	1 410
1 500	758,9	48 x 3,98	13 x 3,98	35,82	2 095	135 300	0,03911	0,04265	0,04984	1 395
1 500	758,9	42 x 3,98	19 x 3,98	35,82	2 095	146 800	0,03967	0,04314	0,05039	1 390
1 500	758,9	33 x 3,98	28 x 3,98	35,82	2 095	158 900	0,04052	0,04393	0,05115	1 380
1 600	809,3	54 x 4,11	7 x 4,11	36,99	2 235	135 300	0,03612	0,03976	0,04656	1 465
1 600	809,3	48 x 4,11	13 x 4,11	36,99	2 235	144 600	0,03661	0,04022	0,04698	1 450
1 600	809,3	42 x 4,11	19 x 4,11	36,99	2 235	156 600	0,03714	0,04072	0,04747	1 445
1 600	809,3	33 x 4,11	28 x 4,11	36,99	2 235	169 500	0,03796	0,04150	0,04829	1 435
1 700	861,3	54 x 4,24	7 x 4,24	38,16	2 375	143 300	0,03402	0,03780	0,04413	1 520
1 700	861,3	48 x 4,24	13 x 4,24	38,16	2 375	153 500	0,03451	0,03822	0,04455	1 505
1 700	861,3	42 x 4,24	19 x 4,24	38,16	2 375	166 400	0,03501	0,03871	0,04505	1 500
1 700	861,3	33 x 4,24	28 x 4,24	38,16	2 375	180 200	0,03576	0,03934	0,04573	1 490
1 750	885,8	54 x 4,30	7 x 4,30	38,70	2 445	147 700	0,03304	0,03684	0,04295	1 550
1 750	885,8	48 x 4,30	13 x 4,30	38,70	2 445	158 000	0,03350	0,03730	0,04344	1 535
1 750	885,8	42 x 4,30	19 x 4,30	38,70	2 445	171 300	0,03399	0,03773	0,04386	1 525
1 750	885,8	33 x 4,30	28 x 4,30	38,70	2 445	185 600	0,03471	0,03835	0,04455	1 520
1 800	910,7	54 x 4,36	7 x 4,36	39,24	2 515	151 700	0,03212	0,03599	0,04190	1 575
1 800	910,7	48 x 4,36	13 x 4,36	39,24	2 515	162 400	0,03258	0,03642	0,04232	1 560
1 800	910,7	42 x 4,36	19 x 4,36	39,24	2 515	176 200	0,03304	0,03684	0,04282	1 550
1 800	910,7	33 x 4,36	28 x 4,36	39,24	2 515	190 900	0,03376	0,03747	0,04344	1 545
1 900	961,6	54 x 4,48	7 x 4,48	40,32	2 655	160 200	0,03041	0,03438	0,03996	1 625
1 900	961,6	48 x 4,48	13 x 4,48	40,32	2 655	171 800	0,03087	0,03481	0,04039	1 610
1 900	961,6	42 x 4,48	19 x 4,48	40,32	2 655	186 000	0,03130	0,03524	0,04091	1 600
1 900	961,6	33 x 4,48	28 x 4,48	40,32	2 655	201 600	0,03199	0,03579	0,04140	1 590
2 000	1 013,8	54 x 4,60	7 x 4,60	41,40	2 793	168 600	0,02890	0,03301	0,03829	1 675
2 000	1 013,8	48 x 4,60	13 x 4,60	41,40	2 793	180 700	0,02930	0,03337	0,03858	1 660
2 000	1 013,8	42 x 4,60	19 x 4,60	41,40	2 793	195 800	0,02972	0,03376	0,03904	1 650
2 000	1 013,8	33 x 4,60	28 x 4,60	41,40	2 793	211 800	0,03038	0,03438	0,03960	1 640

Note 1 – With the following conditions: Ambient temperature = 25°C;
Conductor temperature = 75°C;

Wind velocity = 0,6 m/s. No full sun (Without solar radiation).

Note 2 – Outer layer stranding direction: Right-hand (Z).

APPLICATION

Composite optical ground wire for installation in electric aerial lines.

Recommended for high and extra high voltage aerial power lines.

Designed to have a larger stress-strain window, ensuring longevity of performance over the years.

OPGW – Optical Power Ground Wire

CONSTRUCTION CHARACTERISTICS

The optical fibres are lodged inside a stainless steel tube, filled with a moisture proof gel. For special designs it can be used a stainless steel tube coated with an aluminium tape. The stainless steel tube can be applied to the center or stranded together with the remaining wires of the first layer.

OPGW cable is formed by the stranding of one or more layers of aluminium wires, aluminium alloy, aluminium coated steel or a mixture of them. The use of one or more steel tubes is allowable depending on the number of fibres of the cable. In order to improve resistance to corrosion grease between layers can be applied.

ELECTRICAL, MECHANICAL AND DIMENSIONAL CHARACTERISTICS

OPGW Designation / N.º of fibres (examples)	Outer diameter (mm)	Weight aprox. (kg/km)	Maximum working tension (kgf)	Rated strength (kgf)	Short c. capacity c.c. I _{2t} (a) (kA ₂ .seg.)
OPGW AS 68 ST 1 x 48F	11,4	485	3 050	7 630	18,3
OPGW AS/AA 39/94 AST 2 x 20F	15,8	565	2 895	7 235	90,0
OPGW AS/AA 34/170 ST 1 x 24F	19,0	726	3 600	9 010	320,9
OPGW AS/AA 38/226 ST 2 x 24F	21,7	922	4 700	11 750	541,1

(a) $I_{2t} = \sqrt{\frac{I_{sc}^2 \cdot t}{a}}$

Example: Icc of AS/AA 39/94 cable for 0,5 sec. $\approx \frac{90}{0,5} = 13,4 \text{ kA}$

(Initial temperature before short-circuit: 40°C; final temperature after short-circuit: 200°C)

For other OPGW cables with different n.º of optical fibres, electrical and mechanical characteristics, please contact inform@cabelte.pt for information.

AA – Aluminium alloy;

AS – Aluminium-clad steel;

A – Aluminium;

ST – Stainless Steel tube;

AST – Sainless Steel tube covered with a aluminium tape.

Example: AS/AA 39/94 AST 2x20F – OPGW cable consists of aluminium clad steel wires with total sectional area of 39 mm², aluminium alloy wires with total sectional area of 94 mm² and two aluminium coated stainless steel tubes having 20 optical fibres inside each.



SCHEMATIC CROSS-SECTION

OPGW AS 68 ST 1 x 48F:

Outer diameter = 11,4 mm

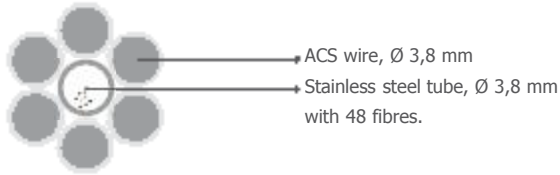

OPGW AS/AA 39/94 AST 2 x 20F:

Outer diameter = 15,8 mm

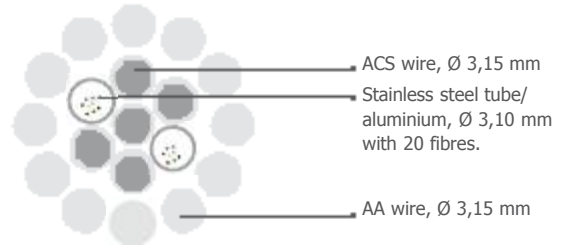

OPGW AS/AA 34/170 ST 1 x 24F:

Outer diameter = 19,0 mm

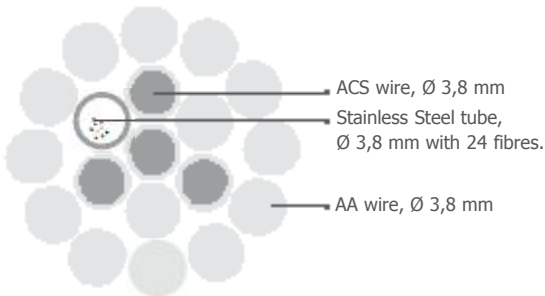

OPGW AS/AA 38/226 ST 2 x 24F:

Outer diameter = 21,7 mm

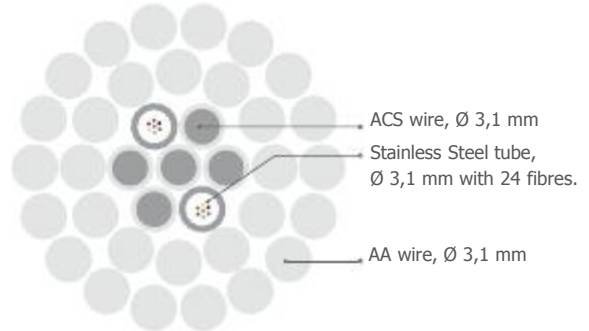

APPLICATION

Composite optical ground wire for installation in electric aerial lines.

Recommended for high and extra high voltage aerial power lines.

Designed to have a larger stress-strain window, ensuring longevity of performance over the years.

OPGW – Optical Power Ground Wire.

CONSTRUCTION CHARACTERISTICS

The optical fibres are lodged inside PBT "loose" tubes filled with gel. The tubes are stranded around a glass fibre (FRP) rod, and this optical core is thermal protected with a special tape.

The interstices of the optical core are filled with a hydrogen-absorbent gel.

The aluminium tube is applied over the optical core. Cable outer layer is made by stranded wires over the aluminium tube. The wires, depending on the final characteristics of the cable, will be of aluminium alloy, aluminium clad steel (aluminium covered steel) or a mixture of both.

ELECTRICAL, MECHANICAL AND DIMENSIONAL CHARACTERISTICS

OPGW Designation / N.º of fibres (examples)	Outer diameter (mm)	Weight aprox. (kg/km)	Maximum working tension (kgf)	Rated strength (kgf)	Short c.c. capacity c.c. I _{2t} (a) (kA ₂ .seg.)
AS/A 59/26 AL – 24F	12,8	479	3 120	7 800	43,2
AS/A 74/32 AL – 48F	14,7	614	3 780	9 460	76,8
AA/AS/A 42/42/52 AL – 24F	15,6	555	2 610	6 530	162
AA/AS/A 65/65/58 AL – 48F	18,5	798	3 710	9 285	288

(a) $I_{2t} = \sqrt{\frac{I_{sc}^2 \cdot t}{k}}$

Example: Icc of AA/AS/A 65/65/58 AL cable for 0,5 sec $\approx \frac{288}{0,5} = 24kA$

(Initial temperature before short-circuit: 40°C; final temperature after short-circuit: 200°C)

For other OPGW cables with different n.º of optical fibres, electrical and mechanical characteristics, please contact inform@cabelte.pt for information.

AA – Aluminium alloy;

AS – Aluminium-clad steel (ARL);

A – Aluminium (tube).

AA/AS/A 65/65/58 – OPGW cable formed by aluminium alloy wires with total sectional area of 65 mm² and aluminium covered steel wires with total sectional area of 65 mm² stranded over an aluminium tube with cross-sectional area of 58 mm².



SCHEMATIC CROSS-SECTION

AS/A 59/26 AL – 24F:

Outer diameter = 12,8 mm

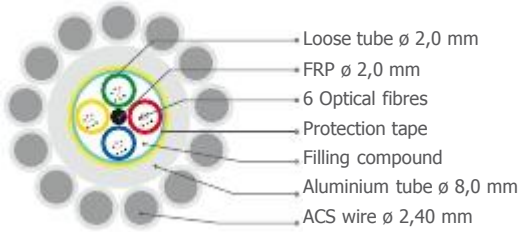

AA/AS/A 42/42/52 AL – 24F:

Outer diameter = 15,6 mm

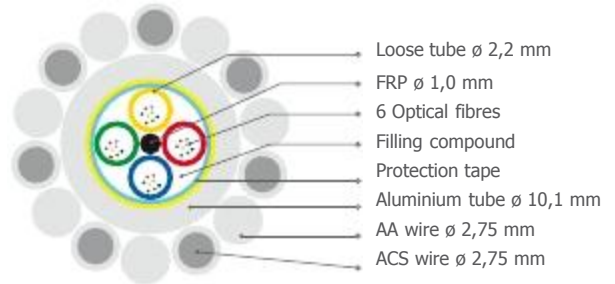

AS/A 74/32 AL – 48F:

Outer diameter = 14,7 mm

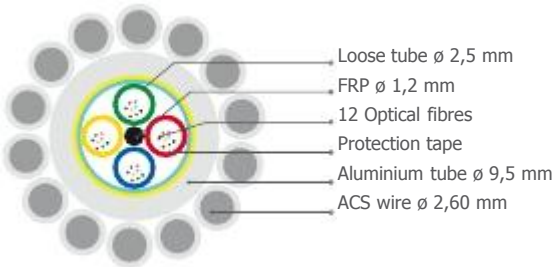

AA/AS/A 65/65/58 AL – 48F:

Outer diameter = 18,8 mm

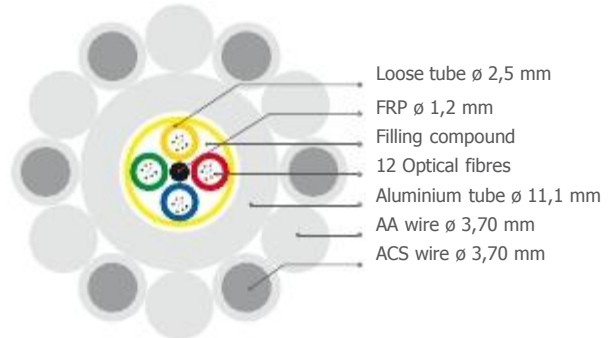

TELECOM COPPER CABLES

SUBSCRIBER NETWORK

Drop cable

- PE insulation, Aerial installation
TE1SE

Indoor cables

- PVC insulation, PVC sheath
TVHV · TVV
- PE insulation, PVC or LSHF sheath
TEV · TEZ1
- PVC insulation, Al screen, PVC sheath
SYT1 0,6/0,9

LOCAL NETWORK

Pair cables

- PE insulation, Al screen, PE or LSHF sheath
TE1HE · TE1HZ1 · TE1HE2AE · TE1HES
- PE insulation, Jelly filled
T1EG1HE · T1EG1HEAE

Quad cables

- PE insulation, Al screen, PE sheath
TE1HE · TE1HEAV · TE1HEAE
- Smart grid, PVC insulation, Al screen, PVC sheath
Téléreport Armé · Téléreport Non Armé

TELECOM COPPER CABLES

APPLICATION

Circular shape cables with 1 or 2 pairs, with transmission characteristics similar to category 3.
For aerial installation in the subscribers network (tensile strength > 1350 N).

CABLE DESIGNATION

TE1SE

CONSTRUCTION CHARACTERISTICS

Conductor

Solid annealed copper, nominal diameter of 0,5 or 0,8 mm.

Insulation

Solid polyethylene.

Arrangement (formation)

Pairs.

Mechanical reinforcement

Aramid yarns applied parallel to the cable core.

Oversheath (jacket)

Black, low density polyethylene (PE).

COLOUR AND CABLE MARKING

Black.

Sheath (jacket) will be marked, at regular intervals, with the following information:
<Manufacturer's name> <type of cable> <year> <metric marking>

COLOUR CODE

N.º Pair	Conductor "a"	Conductor "b"
1	White	Blue
2	Yellow	Black

GENERAL AND ELECTRICAL CHARACTERISTICS (20°C)

	Ø 0,5 mm	Ø 0,8 mm
Maximum Ohmic resistance at 20°C dc(Ω /km)	95	37
Resistance unbalance	Maximum individual value: 2%	
Minimum insulation resistance at 20°C, 500Vdc	10 000 M Ω x km	
Dielectric strength	Cond-Cond – 1kV _{dc} (60s) or 2kV _{dc} (3s)	
Mutual capacitance at 1 kHz	Maximum value: 55 nF/Km	
Maximum capacitance unbalance (pair-pair) (pF/km)(*) 300		

(*) – Only applies to cables with 2 pairs



Frequency (Hz)	Attenuation (dB/km)		Characteristic Impedance (Zc) (Ohm)	Return Loss (RL) (dB)	NEXT (*) (dB)	FEXT (*) (dB)
	Ø 0,5mm	Ø 0,8mm				
800	< 1,5	< 1,0	600 ± 50	Nd	Nd	Nd
64k	< 8,0	< 5,0	125 ± 25	Nd	Nd	Nd
256k	< 11,0	< 7,6	Nd	Nd	Nd	Nd
512k	< 15,5	< 11,0	Nd	Nd	Nd	Nd
772k	< 18,0	< 13,0	100 ± 15	> 18	> 64	>64
1M	< 21,0	< 15,0	100 ± 15	> 18	> 62	>62
4M	< 43,0	< 30,0	100 ± 15	> 18	> 53	>53
10M	< 66,0	< 47,0	100 ± 15	> 15	> 47	>47
16M	< 82,0	< 62,0	100 ± 15	> 15	> 44	>44

(*) – Only applies to cables with 2 pairs • Nd – not defined

DIMENSIONAL CHARACTERISTICS

N.º of pairs	Ø 0,5 mm		Ø 0,8 mm	
	Diameter (mm)	Weight (kg/km)	Diameter (mm)	Weight (kg/km)
1	5,5	23	5,5	27
2	5,5	25	8,0	55

TELECOM COPPER CABLES

APPLICATION

Cables ranging from 1 to 200 pairs, used for inside installations.

CABLE DESIGNATION

TVHV

TVV (without metallic screen)

CONSTRUCTION CHARACTERISTICS

Conductor

Solid annealed copper, nominal diameter of 0,5 mm.

Insulation

PVC.

Arrangement (formation)

Pairs (the two pair cable has the arrangement (formation) of a star-quad).

Core assembly

Units of 10 or 50 pairs.

Core wrapping

Dielectric tape, helically applied with an overlap.

Metallic screen (only for TVHV)

One aluminium/ polyester (9 μ m /12,5 μ m) tape spirally applied, with an overlap. Under the metallic screen a tinned copper wire with nominal diameter of 0,5mm, is longitudinally applied.

Oversheath (jacket)

PVC.

COLOUR AND CABLE MARKING

Grey.

Sheath (jacket) will be marked, at regular intervals, with the following information:

<Manufacturer's name> <type of cable> <year> <metric marking>

COLOUR CODE

N.º Pair	Conductor "a"	Conductor "b"	N.º Pair	Conductor "a"	Conductor "b"
1	White	Blue	6	Red	Blue
2	White	Orange	7	Red	Orange
3	White	Green	8	Red	Green
4	White	Brown	9	Red	Brown
5	White	Grey	10	Red	Grey

For cables with triads, each triad has a black third conductor.



GENERAL AND ELECTRICAL CHARACTERISTICS (20°C)

Maximum Ohmic resistance at 20°C dc(Ω /km)	95,9
Minimum insulation resistance at 20°C, 500Vdc	500 M Ω x km
Dielectric strength (60s)	Cond-Cond – 1kVdc or 1,5kVac
Mutual capacitance at 0,8kHz (maximum value)	
N.º pairs in the cable \leq 6	132 nF/Km
N.º pairs in the cable $>$ 6	120 nF/Km
Maximum capacitance unbalance (pair-pair) (pF/500)	400

DIMENSIONAL CHARACTERISTICS

Pairs • PVC insulation • Al screen • PVC sheath – TVHV

N.º of pairs/triads	Ø 0,5 mm	
	Diameter (mm)	Weight (kg/km)
1x2	3,7	20
1x3	4,1	24
2x2	4,1	26
3x2	5,1	36
6x2	6,1	54
10x2	7,2	77
10x3	9,4	110
15x2	8,0	105
20x2	9,3	140
20x3	12,5	210
30x2	11,5	195
40x2	12,3	245
50x2	13,5	300
60x2	14,5	350
100x2	18,3	555
200x2	25,6	1100

TELECOM COPPER CABLES

APPLICATION

Cables of 1, 2 and 3 pairs used as a connection from inside building up to subscribers' houses.

CABLE DESIGNATION

TEV

TEZ1 (with LSHF sheath)

CONSTRUCTION CHARACTERISTICS

Conductor

Solid annealed copper, nominal diameter of 0,5 mm or 0,6 mm.

Insulation

Solid polyethylene.

Arrangement (Formation)

Pairs (optionally, the two pair cable may have the arrangement (formation) of a star-quad).

Oversheath (jacket)

Extruded PVC or LSHF – Low Smoke Halogen Free thermoplastic compound.

COLOUR AND CABLE MARKING

Ivory.

Sheath (jacket) will be marked, at regular intervals, with the following information:

<Manufacturer's name> <type of cable> <year> <metric marking>

COLOUR CODE

N.º Pair	Conductor "a"	Conductor "b"
1	Brown	White
2	Red	Green
3	Blue	Yellow

GENERAL AND ELECTRICAL CHARACTERISTICS (20°C)

	Ø 0,5 mm	Ø 0,6 mm				
Maximum Ohmic resistance at 20°C dc(Ω /km)	93	66				
Resistance unbalance	Maximum individual value: 2%					
Minimum insulation resistance at 15°C, 500Vdc	8 000 M Ω x km					
Dielectric strength	Cond-Cond – 3kVdc (3s)					
Mutual capacitance at 1 kHz	Maximum value: 56 nF/Km					
Capacitance unbalance (pair-pair) (pF/225m), 800Hz	Maximum value: 510					
Nominal attenuation (dB /Km)	0,8 kHz	1,5 kHz	3 kHz	40 kHz	96 kHz	
	Ø 0,5 mm	1,7	1,8	2,3	9,0	24,5
	Ø 0,6 mm	1,2	1,6	2,0	6,0	19,0

DIMENSIONAL CHARACTERISTICS

Pairs • PE insulation • PVC Sheath – TEV

N.º of pairs	Ø 0,5 mm		Ø 0,8 mm	
	Diameter (mm)	Weight (kg/km)	Diameter (mm)	Weight (kg/km)
1	3,7	17	4,0	20
2	5,0	27	5,9	33
3	5,8	33	6,5	42

TELECOM COPPER CABLES

APPLICATION

Cables ranging from 1 to 112 pairs, used for inside installations.

CABLE DESIGNATION

SYT1

CONSTRUCTION CHARACTERISTICS

Conductor

Solid annealed copper, nominal diameter of 0,6 mm or 0,9 mm.

Insulation

PVC.

Arrangement (Formation)

Pairs.

Core assembly

Concentric layers or bundles for cables with 56 pairs (4x14) or 112 pairs (8x12).

Core wrapping

Dielectric tape, helically applied with an overlap.

Metallic screen

One aluminium/ polyester (9µm /12,5µm) tape spirally applied, with an overlap. Under the metallic screen a tinned copper wire with nominal diameter of 0,5mm, is longitudinally applied.

Oversheath (jacket)

PVC.

COLOUR AND CABLE MARKING

Grey.

Sheath (jacket) will be marked, at regular intervals, with the following information:

<Manufacturer's name> <type of cable> <year> <metric marking>

COLOUR CODE

For cables with pairs in concentric layers, the pairs are identified according to the following table:

Conductor "a"	Conductor "b"						
	White	Blue	Yellow	Brown	Black	Red	Green
Light-Blue	1	2	3	4	5	6	7
Grey	8	9	10	11	12	13	14
Orange	15	16	17	18	19	20	21
Purple	22	23	24	25	26	27	28
Light-Blue	29	30	31	32	33	34	35
Grey	36	37	38	39	40	41	42

For cables assembled in bundles, each bundle will have a winding tape with the following successively colours:
White • blue • yellow • brown • black • red • green • purple.



GENERAL AND ELECTRICAL CHARACTERISTICS (20°C)

	Ø 0,6 mm	Ø 0,9 mm
Maximum Ohmic resistance at 20°C dc(Ω /km)	133,4	59,3
Minimum insulation resistance at 20°C, 500Vdc	500 M Ω x km	
Dielectric strength (60s)	Cond-Cond – 1,5kVdc	
Mutual capacitance at 0,8kHz (maximum value)		
N.º pairs in the cable < 10	160 nF/Km	
N.º pairs in the cable \geq 10	130 nF/Km	
Maximum capacitance unbalance (pair-pair) (pF/500)	400	

DIMENSIONAL CHARACTERISTICS

Pairs • PVC insulation • Al screen • PVC sheath – SYT1

N.º of pairs	Ø 0,6 mm		Ø 0,9 mm	
	Diameter (mm)	Weight (kg/km)	Diameter (mm)	Weight (kg/km)
1	4,2	26	5,2	40
2	5,5	40	7,6	75
3	5,7	50	7,9	90
5	7,0	75	9,2	130
7	7,6	90	10,5	170
10	8,6	115	12,0	225
15	9,6	155	13,5	310
21	11,3	210	15,5	410
30	13,0	280	18,4	580
56	16,6	480	24,5	1020
112	23,1	910	34,0	1980

TELECOM COPPER CABLES

APPLICATION

Cables ranging from 6 to 2 424 pairs, for distribution to subscribers or connecting multiline telephone systems. Suitable for underground or duct installation. Can be used for aerial installation with a suspension strand.

CABLE DESIGNATION

TE1HE · TE1HZ1 (PE or LSHF sheath)

TE1HE2AE (corrugated armoured cable)

TE1HES (figure 8 cables, for aerial installation)

CONSTRUCTION CHARACTERISTICS

Conductor

Solid annealed copper, nominal diameter of 0,40; 0,51; 0,64 and 0,91 mm.

Insulation

Solid polyethylene.

Arrangement (formation)

Pairs.

Core assembly

Units of 12, 13, 25, 50 and 100 pairs.

Core wrapping

Dielectric tape, helically applied with an overlap.

Shield (screen)

Aluminium tape with copolymer on both sides, applied longitudinally with an overlap.

Inner sheath (jacket)

Armoured cables shall have a black, low density polyethylene (PE).
or fire proof material (halogen free) sheath.

Armour

Armoured cables shall have a corrugated steel tape applied longitudinally with an overlap.

Oversheath (jacket)

Low density polyethylene (PE) or LSHF – Low Smoke Halogen Free thermoplastic compound, fire retardant

Steel strength member (fig.8 cables)

Cables for aerial installation shall have a galvanized steel wires strand.

COLOUR AND CABLE MARKING

Black.

Sheath (jacket) will be marked, at regular intervals, with the following information:

<Manufacturer's name> <type of cable> <year> <metric marking>



COLOUR CODE

N.º Pair	Conductor "a"	Conductor "b"	N.º Pair	Conductor "a"	Conductor "b"
1	White	Blue	14	Black	Brown
2	White	Orange	15	Black	Grey
3	White	Green	16	Yellow	Blue
4	White	Brown	17	Yellow	Orange
5	White	Grey	18	Yellow	Green
6	Red	Blue	19	Yellow	Brown
7	Red	Orange	20	Yellow	Grey
8	Red	Green	21	Violet	Blue
9	Red	Brown	22	Violet	Orange
10	Red	Grey	23	Violet	Green
11	Black	Blue	24	Violet	Brown
12	Black	Orange	25	Violet	Grey
13	Black	Green	26	White	Black

GENERAL AND ELECTRICAL CHARACTERISTICS (20°C)

Flame retardant	IEC 60332-1-2 • EN 60332-1-2 (cable vertically mounted, length of charred cable ≤ 540 mm)
Fire retardant	IEC 60332-3-24 • EN 60332-3-24 (bunch of cables vertically mounted on a ladder, length of charred cables ≤ 2,5 m)
Halogen free	
Low smoke	IEC 61034-2 • EN 61034-2 (cable light transmittance ≥ 60%)
Low toxicity	IEC 60754-1 • EN 50267-2-1 (halogen acid gas content ≤ 0,5%)
Low corrosivity	IEC 60754-2 • EN 50267-2-3 (LSFH sheath: pH ≥ 4,3 • conductivity ≤ 10µS/mm)

	Ø 0,40 mm	Ø 0,51 mm	Ø 0,64 mm	Ø 0,91 mm
Maximum Ohmic resistance at 20°C dc(Ω/km)	144,2	89,5	56,6	28,5
Dielectric strength (Vdc, 3s)	Cond-Cond	2 500	3 000	3 600
	Cond-Screen	5 000	5 000	10 000
Far-end crosstalk (ELFEXT) (dB/km, 1MHz)	Min	57	57	57
	Average Min	35	35	37
Nominal attenuation (dB/km)	0,8 kHz	1,64	1,30	1,04
	3 kHz	3,18	2,52	2,01
	150 kHz	11,40	8,30	6,20
	1 MHz	27,10	21,40	17,50
Near-end crosstalk (NEXT) (dB, 500 m, 1MHz)	N.º pairs ≤ 51	N.º pairs > 51		
	(Average-σ)	>50	>55	
	Minimum	40	45	
Resistance unbalance	Average: max. value: 1,5% Maximum individual value: 5%			

TELECOM COPPER CABLES

Minimum insulation resistance at 15°C, 500Vdc	20 000 MΩ x km		
Mutual capacitance at 1 kHz	Average value: 52 ± 3 nF/Km		
	Maximum value: 58 nF/Km		
Capacitance unbalance (pF/km, 800Hz)		Rms. max	Average max. Max. value
	Pair-pair (<12p)	---	---
	Pair-pair (>12p)	45	---
	Pair-ground (<12p)	---	2 625
	Pair-ground (>12p)	---	574 2 625

DIMENSIONAL CHARACTERISTICS

Outdoor cable · Pairs · PE insulation · Al screen · PE · Dry core – TE1HE

N.º of Pairs	Ø 0,40 mm		Ø 0,51 mm		Ø 0,64 mm		Ø 0,91 mm	
	Diameter (mm)	Weight (kg/km)	Diameter (mm)	Weight (kg/km)	Diameter (mm)	Weight (kg/km)	Diameter (mm)	Weight (kg/km)
6	7,8	60	8,6	80	9,8	100	11,9	160
11	8,9	90	10,0	110	11,5	150	14,3	250
16	9,7	100	11,0	140	12,8	200	16,1	330
21	10,5	130	12,0	170	14,0	240	17,8	410
26	11,2	140	12,9	200	15,1	290	19,3	490
31	11,8	160	13,7	230	16,1	330	20,9	580
51	13,9	230	16,7	350	19,8	510	25,6	900
76	16,4	330	19,8	490	23,7	740	31,3	1 330
101	18,2	420	22,2	630	26,6	950	35,4	1 740
152	21,7	600	26,1	900	31,6	1 370	42,3	2 540
202	24,4	770	30,1	1 160	36,6	1 790	49,4	3 350
303	28,8	1 100	35,8	1 690	43,7	2 600	59,5	4 930
404	32,6	1 430	40,6	2 200	50,1	3 430	68,0	6 500
606	39,0	2 090	49,0	3 240	60,4	5 070	82,0	9 600
909	47,2	3 100	59,0	4 790	73,0	7 540		
1 212	53,7	4 060	67,5	6 310	83,2	9 900		
1 515	59,2	5 000	74,8	7 810				
1 818	64,6	5 980	81,2	9 290				
2 121	69,2	6 910						
2 222	70,7	7 220						
2 424	73,9	7 890						

Indoor cable • Pairs • PE insulation • Al screen • LSHF sheath • Dry core – TE1HZ1

N.º of Pairs	Ø 0,40 mm		Ø 0,51 mm		Ø 0,64 mm		Ø 0,91 mm	
	Diameter (mm)	Weight (kg/km)	Diameter (mm)	Weight (kg/km)	Diameter (mm)	Weight (kg/km)	Diameter (mm)	Weight (kg/km)
6	7,8	80	8,6	100	9,8	130	11,9	190
11	8,9	110	10,0	140	11,5	180	14,3	280
16	9,7	130	11,0	170	12,8	230	16,1	370
21	10,5	150	12,0	200	14,0	270	17,8	460
26	11,2	170	12,9	230	15,1	320	19,3	540
31	11,8	190	13,7	260	16,1	370	20,9	640
51	13,9	270	16,7	390	19,8	570	25,6	970
76	16,4	370	19,8	550	23,7	820	31,3	1 450
101	18,2	470	22,2	700	26,6	1 040	35,4	1 880
152	21,7	670	26,1	990	31,6	1 490	42,3	2 710
202	24,4	860	30,1	1 270	36,6	1 930	49,4	3 570
303	28,8	1 200	35,8	1 820	43,7	2 780	59,5	5 210
404	32,6	1 550	40,6	2 360	50,1	3 660	68,0	6 850
606	39,0	2 240	49,0	3 460	60,4	5 360	82,0	10 050
909	47,2	3 310	59,0	5 080	73,0	7 940		
1 212	53,7	4 310	67,5	6 670	83,2	10 350		
1 515	59,2	5 280	74,8	8 220				
1 818	64,6	6 300	81,2	9 730				
2 121	69,2	7 260						
2 222	70,7	7 580						
2 424	73,9	8 290						

TELECOM COPPER CABLES

Outdoor cable · Pairs · PE insulation · Al screen · PE · Corrugated armour · PE – TE1HE2AE

N.º of Pairs	Ø 0,40 mm		Ø 0,51 mm		Ø 0,64 mm		Ø 0,91 mm	
	Diameter (mm)	Weight (kg/km)	Diameter (mm)	Weight (kg/km)	Diameter (mm)	Weight (kg/km)	Diameter (mm)	Weight (kg/km)
6	12,4	160	12,4	180	14,4	210	16,4	290
11	13,4	190	14,4	220	15,4	270	18,5	390
16	14,4	210	15,4	260	17,5	330	21,0	490
21	14,4	240	16,4	300	18,5	380	22,8	600
26	15,4	260	17,5	330	19,5	440	24,2	690
31	16,4	290	17,5	360	21,2	490	26,0	800
51	18,5	380	21,0	500	24,2	700	30,6	1 160
76	21,0	490	24,2	680	28,9	970	36,9	1 650
101	22,6	600	27,3	850	32,1	1 220	42,2	2 120
152	25,8	810	30,6	1 160	36,9	1 690	49,2	3 010
202	28,9	1 010	35,1	1 460	42,2	2 170	55,7	3 900
303	33,6	1 390	42,0	2 050	49,2	3 070	66,9	5 640
404	37,6	1 770	46,2	2 630	57,2	4 000	76,3	7 330
606	46,0	2 510	55,7	3 790	68,5	5 800	90,2	10 620
909	54,0	3 620	66,7	5 490	80,9	8 430		
1 212	60,5	4 670	74,8	7 130	91,8	10 930		
1 515	66,9	5 740	82,4	8 720				
1 818	71,7	6 760	88,7	10 280				
2 121	77,8	7 790						
2 222	77,8	8 100						
2 424	82,4	8 790						

Outdoor cable • Pairs • PE insulation • Al screen • PE • Aerial installation – TE1HES

N.º of Pairs	Ø 0,40 mm		Ø 0,51 mm		Ø 0,64 mm		Ø 0,91 mm	
	Diameter (mm)	Weight (kg/km)	Diameter (mm)	Weight (kg/km)	Diameter (mm)	Weight (kg/km)	Diameter (mm)	Weight (kg/km)
6	7,6	210	8,4	230	9,6	250	11,7	310
11	8,7	230	9,8	260	11,3	300	14,1	390
16	9,5	250	10,8	290	12,6	340	15,9	470
21	10,3	270	11,8	320	13,8	390	17,6	650
26	11,0	290	12,7	340	14,9	430	19,1	730
31	11,6	310	13,5	370	15,9	470	21,1	830
51	13,7	380	16,1	480	19,2	640	25,8	1 150
76	15,8	460	18,8	610	23,1	960	30,5	1 540
101	17,6	550	21,6	860	26,0	1 170	34,4	1 930
152	21,3	830	25,5	1 120	30,8	1 580		
202	23,8	1 000	29,3	1 380				
303	28,2	1 320						

Steel messenger type	Minimum breaking load (daN)	Nº of Pairs			
		Ø 0,40 mm	Ø 0,51 mm	Ø 0,64 mm	Ø 0,91 mm
7x1,6mm	1 570	≤ 101	≤ 76	≤ 51	≤ 16
7x2,1mm	2 600	> 101	> 76	> 51	> 16

TELECOM COPPER CABLES

APPLICATION

Cables ranging from 10 to 2400 pairs, for distribution to subscribers or connecting multiline telephone systems. Suitable for underground or duct installation.

CABLE DESIGNATION

T1EG1HE

T1EG1HEAE (armoured cable)

CONSTRUCTION CHARACTERISTICS

Conductor

Solid annealed copper, nominal diameter of 0,4; 0,5; 0,6 and 0,9 mm.

Insulation

Cellular (foam-skin) polyethylene.

Arrangement (formation)

Pairs.

Core assembly

Units of 10, 50 and 100 pairs.

Filling compound

Waterblocking compound, compatible with all the remaining cable components.

Core wrapping

Dielectric tape, helically applied with an overlap.

Shield (screen)

Aluminium tape with copolymer on one side, applied longitudinally with an overlap.

Inner sheath (jacket)

Armoured cables shall have a black, low density polyethylene (PE) sheath.

Armour

Armoured cables shall have a double steel tape armour, helically applied.

Oversheath (jacket)

Black, low density polyethylene (PE).

COLOUR AND CABLE MARKING

Black.

Sheath (jacket) will be marked, at regular intervals, with the following information:

<Manufacturer's name> <type of cable> <year> <metric marking>

COLOUR CODE

N.º Pair	Conductor "a"	Conductor "b"	N.º Pair	Conductor "a"	Conductor "b"
1	White	Blue	6	Red	Blue
2	White	Orange	7	Red	Orange
3	White	Green	8	Red	Green
4	White	Brown	9	Red	Brown
5	White	Grey	10	Red	Grey



GENERAL AND ELECTRICAL CHARACTERISTICS (20°C)

	Ø 0,4 mm	Ø 0,5 mm	Ø 0,6 mm	Ø 0,9 mm
Maximum Ohmic resistance at 20°C dc(Ω /km)	Maximum	150	95,9	66,6
	Average Max	144	92,1	63,9
Dielectric strength (Vdc, 3s)	Cond-Cond	1 000 / 500		
	Cond-Screen	2 000 / 1 000		
Resistance unbalance maximum (%)	2,5%			
Minimum insulation resistance at 15°C, 500Vdc	10 000 M Ω x km			
Mutual capacitance at 1 kHz	(*) Average maximum: 55 nF/Km			
	Maximum value: 64 nF/Km			
Capacitance unbalance max. (pF/km, 800Hz)	400			

(*) – only applied to cables with more than 20 pairs.

DIMENSIONAL CHARACTERISTICS

Outdoor cable • Pairs • PE foam-skin insulation • Al screen • PE • Jelly filled – T1EG1HE

N.º of Pairs	Ø 0,4 mm		Ø 0,5 mm		Ø 0,6 mm		Ø 0,9 mm	
	Diameter (mm)	Weight (kg/km)	Diameter (mm)	Weight (kg/km)	Diameter (mm)	Weight (kg/km)	Diameter (mm)	Weight (kg/km)
10	9	80	10	100	11	140	14	240
20	10	120	11	160	14	220	17	420
30	12	160	13	220	16	300	21	600
50	14	250	16	340	19	450	25	950
100	18	450	21	600	25	850	35	1800
150	22	650	25	900	31	1300	42	2750
200	25	850	28	1200	35	1750	48	3600
300	29	1250	36	1750	44	2600	60	5350
400	34	1650	40	2300	50	3400		
600	40	2400	49	3400	60	5000		
800	46	3150	56	4500	68	6600		
900	49	3500	58	5000	72	7400		
1000	51	3900	61	5600	75	8200		
1200	56	4650	67	6600				
1600	64	6100	76	8800				
1800	68	6900	79	9800				
2000	71	7600						
2400	78	9100						

TELECOM COPPER CABLES

APPLICATION

Cables ranging from 1 to 52 quads, for distribution to subscribers or connecting multiline telephone systems. Suitable for underground or duct installation.

CABLE DESIGNATION

TE1HE

TE1HEAV · TE1HEAE (armoured cable)

CONSTRUCTION CHARACTERISTICS

Conductor

Solid annealed copper, nominal diameter of 0,6 or 0,9 mm.

Insulation

Solid polyethylene.

Arrangement (formation)

Star-quads.

Core assembly

In layers.

Core wrapping

Dielectric tape, helically applied with an overlap.

Shield (screen)

Aluminium tape with copolymer on one side, applied longitudinally with an overlap.

Inner sheath (jacket)

Armoured cables shall have a black, low density polyethylene (PE) sheath.

Armour

Armoured cables shall have a double steel tape armour, helically applied.

Oversheath (jacket)

Black, low density polyethylene (PE) or PVC (in option for armoured cables).

COLOUR AND CABLE MARKING

Black.

Sheath (jacket) will be marked, at regular intervals, with the following information:

<Manufacturer's name> <type of cable> <year> <metric marking>

COLOUR CODE

	Insulation colour				
	Cond. "a"	Cond. "b"		Cond. "c"	Cond. "d"
Quad position in the centre or in the layer		Centre and even quads	Odd quads		
1st (pilot)	Yellow	White	Violet	Green	Grey
2nd, 4rd, 6th, etc.	Blue	White	Violet	Green	Grey
3rd, 5th, 7th, etc	Red	White	Violet	Green	Grey
Last (reference)	Brown	White	Violet	Green	Grey



GENERAL AND ELECTRICAL CHARACTERISTICS (20°C)

		Ø 0,6 mm	Ø 0,9 mm
Maximum Ohmic resistance at 20°C dc(Ω /km)	Maximum	66,6	29,0
	Average Max	63,9	27,8
Dielectric strength (Vdc, 3s)	Cond-Cond (3s or 60s)	2 000 / 1 000	
	Cond-Screen (3s or 60s)	6 000 / 3 000	
Resistance unbalance maximum (%)		2,5	2,0
Mutual capacitance at 800Hz – average (nF/km)		42±5%	41±5%
Minimum insulation resistance at 15°C, 500Vdc		20 000 M Ω x km	
		Max. Average value	Max. value
Capacitance unbalance (pF/km, 800Hz)	Pair-pair:		
	Same quad	40	150
	Adjacent quads	40	170
	Pair-ground	150	600

DIMENSIONAL CHARACTERISTICS

Quads – PE insulation /Al screen /PE – TE1HE

N.º of Pairs	Ø 0,6 mm		Ø 0,9 mm	
	Diameter (kg/km)	Weight (kg/km)	Diameter (mm)	Weight (kg/km)
1	8	60	9	90
3	11	110	14	180
7	14	180	17	330
12	16	270	22	530
14	17	310	24	610
19	20	410	28	830
27	23	550	32	1130
30	25	640	33	1230
37	27	750	36	1470
48	30	930	40	1850
52	31	1000	42	1980

TELECOM COPPER CABLES

APPLICATION

Cable with one quad, used for inside installations and used to transmit the readings for consumed and delivered energy to a remote unit.

CABLE DESIGNATION

Cable Téléreport armé

Cable Téléreport non-armé

CONSTRUCTION CHARACTERISTICS

Conductor

Solid annealed copper, nominal diameter of 0,6 mm.

Insulation

PVC.

Arrangement (formation)

Star-quads.

Core wrapping

Dielectric tape, helically applied with an overlap.

Metallic screen (only for TVHV)

One aluminium/ polyester (9µm /12,5µm) tape spirally applied, with an overlap. Under the metallic screen a tinned copper wire with nominal diameter of 0,5 mm, is longitudinally applied.

Inner sheath (jacket)

PVC, colour: ivory.

Armour

The armoured cables shall have a double steel tape armour, helically applied.

Oversheath (jacket)

The armoured cables shall have an oversheath of PVC.

COLOUR AND CABLE MARKING

Black.

Sheath (jacket) will be marked, at regular intervals, with the following information:

<type of cable> <Manufacturer's name> <Manufacturer order> <Reference standard>

COLOUR CODE

N.º Quad	Conductor "a"	Conductor "b"	Conductor "c"	Conductor "d"
1	White	Blue	Red	Dark Blue



GENERAL AND ELECTRICAL CHARACTERISTICS (20°C)

Ohmic resistance at 20°C dc(Ω /km)	Minimum	120
	Maximum	133,2
Mutual capacitance at 50kHz (nF/km)	Minimum	80
	Maximum	130
Impedance characteristic at 50kHz (Ohm)	Minimum	75
	Maximum	115
Minimum insulation resistance at 20°C, 500Vdc		100 M Ω x km
Dielectric strength (Vac) (60s)	Cond-Cond	1500
	Cond-Screen	1500

DIMENSIONAL CHARACTERISTICS

(1) – Quad - PVC insulation • Al screen • PVC sheath – Cable Téléreport non-armé

(2) – Quad - PVC insulation • Al screen • PVC sheath • Armour • PVC sheath – Cable Téléreport armé

N.° of Quad	NON-ARMOURED (1)		ARMOURED (2)	
	Diameter (mm)	Weight (kg/km)	Diameter (mm)	Weight (kg/km)
1	5,3	40	10	140

RAILWAY SIGNALING CABLES

Pair Cables

- PE insulation · Al screen · Corrugated armour · Dry core
TE1HE2AE • TE1HZ12AZ1 • TE1HE2AES
- PE insulation · Al screen · Corrugated armour · Jelly filled
TEG1HE2AE

Quad Cables

- PE insulation · Al screen · Corrugated armour · Dry core
TE1HE2AE • TE1HZ12AZ1 • TE1HE2AES
- PE insulation · Al screen · Corrugated armour · Jelly filled
TEG1HE2AE

CABLES WITH REDUCTION FACTOR

Pair Cables

- PE insulation · Copper screen + armour · PVC
ZPAU
- PE insulation · Copper or Al screen + armour · PE or LSHF
TEOEAE · TEOZ1AZ1 · TE1REAE · TE1RZ1AZ1 · TE3HEAE · TE3HZ1AZ1
- PE insulation · Copper or Al screen + armour · PE · Jelly filled
TEGOEAE • TEG1REAE

Quad Cables

- PE insulation · Copper or Al screen + armour · PE or LSHF
TEOEAE · TEOZ1AZ1 · TE1REAE · TE1RZ1AZ1 · TE3HEAE · TE3HZ1AZ1
- PE insulation · Copper or Al screen + armour · PE · Jelly filled
TEGOEAE • TEG1REAE

APPLICATION

Cables ranging from 3 to 150 pairs, used as control and signalling cables. The sheath offers special protection of the core against rodents. Indicated for installations, indoor or outdoor, protected or not. Can be installed directly buried and some types can be used for aerial self-supported installation.

CABLE DESIGNATION

PE insulation / Aluminium tape screen / PE / Steel corrugated tape armour /PE: TE1HE2AE

PE insulation / Aluminium tape screen / LSHF / Steel corrugated tape armour / LSHF: TE1HZ12AZ1

PE insulation / Aluminium tape screen / PE / Steel corrugated tape armour /PE /Steel messenger: TE1HE2AES

CONSTRUCTION CHARACTERISTICS

Conductor

Solid annealed copper, nominal diameter of 0,64; 0,9 and 1,3 mm.

Insulation

Solid polyethylene.

Arrangement (formation)

Pairs.

Core assembly

Units of 12, 13, 25 pairs.

Core wrapping

Dielectric tape, helically applied with an overlap.

Shield (screen)

Aluminium tape with copolymer on both sides, applied longitudinally with an overlap.

Inner sheath (jacket)

Black, low density polyethylene (PE) or LSHF – Low Smoke Halogen Free thermoplastic compound.

Armour

Corrugated steel tape applied longitudinally with an overlap.

Oversheath (jacket)

Black, low density polyethylene (PE) or LSHF – Low Smoke Halogen Free thermoplastic compound, fire retardant.

Steel strength member (fig.8 cables)

Galvanized steel wires strand.

COLOUR AND CABLE MARKING

Black. Sheath (jacket) will be marked, at regular intervals, with the following information:

<Manufacturer's name> <type of cable> <year> <metric marking>



COLOUR CODE

N.º Pair	Conductor "a"	Conductor "b"	N.º Pair	Conductor "a"	Conductor "b"
1	White	Blue	14	Black	Brown
2	White	Orange	15	Black	Grey
3	White	Green	16	Yellow	Blue
4	White	Brown	17	Yellow	Orange
5	White	Grey	18	Yellow	Green
6	Red	Blue	19	Yellow	Brown
7	Red	Orange	20	Yellow	Grey
8	Red	Green	21	Violet	Blue
9	Red	Brown	22	Violet	Orange
10	Red	Grey	23	Violet	Green
11	Black	Blue	24	Violet	Brown
12	Black	Orange	25	Violet	Grey
13	Black	Green	26	White	Black

GENERAL AND ELECTRICAL CHARACTERISTICS (20°C)

	Ø 0,64 mm	Ø 0,9 mm	Ø 1,3 mm	
Maximum Ohmic resistance at 20°C dc(Ω/km)	58,0	29,0	13,9	
Nominal attenuation (dB/km)	0,8 kHz	1,04	0,74	
	1,5 kHz	1,42	1,01	
	3 kHz	2,01	1,42	
	1 MHz	17,5	12,8	
Resistance unbalance	Maximum/average value: 1% Maximum individual value: 2%			
Minimum insulation resistance at 15°C, 500Vdc	35 000 MΩ x km			
Dielectric strength (3s)	Cond-Cond – 3 kVdc or 2,1 kVac Cond-Screen – 3,5 kVdc or 2,5 kVac			
Mutual capacitance at 1 kHz	Average value: 52 ± 4 nF/Km Maximum value: 58 nF/Km			
Capacitance unbalance (pF/km, 1 kHz)	Max. Average value	Max. value		
	Pair-pair	45	260	
	Pair-ground	650	2625	

ADDITIONAL CHARACTERISTICS*

Flame retardant	IEC 60332-1-2 • EN 60332-1-2 (cable vertically mounted, length of charred cable ≤ 540 mm)
Fire retardant	IEC 60332-3-24 • EN 60332-3-24 (bunch of cables vertically mounted on a ladder, length of charred cables ≤ 2,5 m)
Halogen free	
Low smoke	IEC 61034-2 • EN 61034-2 (cable light transmittance ≥ 60%)
Low toxicity	IEC 60754-1 • EN 50267-2-1 (halogen acid gas content ≤ 0,5%)
Low corrosivity	IEC 60754-2 • EN 50267-2-3 (LSFH sheath: pH ≥4,3 • conductivity ≤ 10μS/mm)

* Applicable only for TE1HZ12AZ1 cable.

DIMENSIONAL CHARACTERISTICS

PE insulation • Al screen • PE • Corrugated Armour • PE – TE1HE2AE

N.º of pairs	Ø 0,64 mm		Ø 0,9 mm		Ø 1,3 mm	
	Diameter (mm)	Weight (kg/km)	Diameter (mm)	Weight (kg/km)	Diameter (mm)	Weight (kg/km)
3	13,0	180	15,0	220	17,0	310
4	14,0	200	16,0	260	18,0	360
7	15,0	230	17,0	320	21,5	490
10	16,0	270	19,0	390	23,5	620
15	17,0	330	20,0	480	26,5	820
20	18,0	380	23,0	600	29,5	1020
25	19,0	430	24,5	700	31,0	1200
50	24,5	700	31,0	1160	42,5	2150
75	28,0	940	35,5	1600	51,0	3060
100	31,0	1170	41,0	2040	57,5	3950
150	35,5	1620	48,0	2890	68,0	5710

RAILWAY SIGNALING CABLE

APPLICATION

Cables ranging from 3 to 150 pairs, used as control and signalling cables. The sheath offers special protection of the core against rodents. Recommended for duct or direct buried installations.

CABLE DESIGNATION

PE insulation / Jelly /Aluminium screen / PE / Steel armour /PE: TEG1HE2AE

CONSTRUCTION CHARACTERISTICS

Conductor

Solid annealed copper, nominal diameter of 0,64; 0,9 and 1,3 mm.

Insulation

Solid polyethylene.

Arrangement (formation)

Pairs.

Core assembly

Units of 12, 13, 25 pairs.

Filling compound

Waterblocking compound, compatible with all the remaining cable components.

Core wrapping

Dielectric tape, helically applied with an overlap.

Shield (screen)

Aluminium tape with copolymer on both sides, applied longitudinally with an overlap.

Inner sheath (jacket)

Black, low density polyethylene (PE).

Armour

Corrugated steel tape applied longitudinally with an overlap.

Oversheath (jacket)

Black, low density polyethylene (PE).

COLOUR AND CABLE MARKING

Black.

Sheath (jacket) will be marked, at regular intervals, with the following information:

<Manufacturer's name> <type of cable> <year> <metric marking>

COLOUR CODE

N.º Pair	Conductor "a"	Conductor "b"	N.º Pair	Conductor "a"	Conductor "b"
1	White	Blue	8	Red	Green
2	White	Orange	9	Red	Brown
3	White	Green	10	Red	Grey
4	White	Brown	11	Black	Blue
5	White	Grey	12	Black	Orange
6	Red	Blue	13	Black	Green
7	Red	Orange	14	Black	Brown



N.º Par	Conductor "a"	Conductor "b"	N.º Par	Conductor "a"	Conductor "b"
15	Black	Grey	21	Violet	Blue
16	Yellow	Blue	22	Violet	Orange
17	Yellow	Orange	23	Violet	Green
18	Yellow	Green	24	Violet	Brown
19	Yellow	Brown	25	Violet	Grey
20	Yellow	Grey	26	White	Black

GENERAL AND ELECTRICAL CHARACTERISTICS (20°C)

	Ø 0,64 mm	Ø 0,9 mm	Ø 1,3 mm
Maximum Ohmic resistance at 20°C dc(Ω/km)	58,0	29,0	13,9
Nominal attenuation (dB/km)	0,8 kHz	1,04	0,52
	1,5 kHz	1,42	0,71
	3 kHz	2,01	1,01
	1 MHz	17,5	8,62
Resistance unbalance	Maximum/average value: 1% Maximum individual value: 2%		
Minimum insulation resistance at 15°C, 500Vdc	25 000 MΩ x km		
Dielectric strength (3s)	Cond-Cond – 3 kVdc or 2,1 kVac Cond-Screen – 3,5 kVdc or 2,5 kVac		
Mutual capacitance at 1 kHz	Average value: 52 ± 4 nF/Km Maximum value: 58 nF/Km		
Capacitance unbalance (pF/km, 1 kHz)	Max. Average value		Max. value
	Pair-pair	45	260
	Pair-ground	650	2625

DIMENSIONAL CHARACTERISTICS

PE insulation • Al screen • PE • Corrugated Armour • PE • Jelly filled – TEG1HE2AE

N.º of pairs	Ø 0,64 mm		Ø 0,9 mm		Ø 1,3 mm	
	Diameter (mm)	Weight (kg/km)	Diameter (mm)	Weight (kg/km)	Diameter (mm)	Weight (kg/km)
3	14,0	200	15,0	250	19,0	390
4	15,0	230	16,0	290	20,0	450
7	16,0	280	18,0	380	23,5	620
10	18,0	340	20,0	470	26,5	800
15	19,0	400	22,0	580	29,5	1060
20	20,0	470	25,0	730	32,5	1330
25	21,5	550	27,0	870	36,0	1610
50	28,0	910	35,0	1490	50,0	3000
75	32,5	1250	42,0	2110	59,5	4290
100	35,5	1560	47,5	2690	67,0	5550
150	43,0	2210	55,5	3830	79,5	8010

APPLICATION

Cables ranging from 1 to 28 star quads used as control and signalling cables. Sheaths used are designed to offer special protection against rodents. Indicated for installations, indoor or outdoor, protected or not. Can be installed directly buried and some types can be used for aerial self-supported installation.

CABLE DESIGNATION

PE insulation / Aluminium tape screen / PE / Steel corrugated tape armour /PE: TE1HE2AE

PE insulation / Aluminium tape screen / LSHF / Steel corrugated tape armour / LSHF: TE1HZ12AZ1

PE insulation / Aluminium tape screen / PE / Steel corrugated tape armour /PE /Steel messenger: TE1HE2AES

CONSTRUCTION CHARACTERISTICS

Conductor

Solid annealed copper, nominal diameter of 0,9; 1,3 and 1,4 mm.

Insulation

Solid polyethylene.

Arrangement (formation)

Star-quads.

Core assembly

In layers.

Core wrapping

Dielectric tape, helically applied with an overlap.

Shield (screen)

Aluminium tape with copolymer on both sides, applied longitudinally with an overlap.

Inner sheath (jacket)

Black, low density polyethylene (PE) or LSHF – Low Smoke Halogen Free thermoplastic compound.

Armour

Corrugated steel tape applied longitudinally with an overlap.

Oversheath (jacket)

Black, low density polyethylene (PE) or LSHF – Low Smoke Halogen Free thermoplastic compound, fire retardant.

Steel strength member (fig.8 cables)

Galvanized steel wires strand.

COLOUR AND CABLE MARKING

Black.

Sheath (jacket) will be marked, at regular intervals, with the following information:

<Manufacturer's name> <type of cable> <year> <metric marking>



COLOUR CODE

	Insulation colour				
	Cond. "a"	Cond. "b"	Cond. "c"	Cond. "d"	
Quad position in the centre or in the layer				Centre and even quads	Odd quads
1st (pilot)	Orange	Green	Red	White	Black
2nd, 4rd, 6th, etc.	Yellow	Green	Blue	White	Black
3rd, 5th, 7th, etc	Yellow	Green	Red	White	Black
Last (reference)	Orange	Green	Blue	White	Black

GENERAL AND ELECTRICAL CHARACTERISTICS (20°C)

		Ø 0,9 mm	Ø 1,3 mm	Ø 1,4 mm
Maximum Ohmic resistance at 20°C dc(Ω/km)		29,0	13,9	11,9
Mutual capacitance at 1 kHz (nF/km)	Average value	38 ± 3	41 ± 4	41 ± 4
	Maximum value	45	48	50
Resistance unbalance	Maximum individual value: 2,5%			
Minimum insulation resistance at 15°C, 500Vdc	35 000 MΩ x km			
Dielectric strength (3s)	Cond-Cond – 3 kVdc or 2,1 kVac			
	Cond-Screen – 3,5 kVdc or 2,5 kVac			
Mutual capacitance at 1 kHz	Average value: 52 ± 4 nF/Km			
	Maximum value: 58 nF/Km			
Capacitance unbalance (pF/460m, 1 kHz)		Max. Average value ⁽¹⁾	Max. value	
	Pair-pair:			
	Same quad	35	250	
	Adjacent quads	35	250	
	Non adjacent quads	----	250	
Pair-ground	320	1200		

(1) Average limits only apply for cables with more than seven quads.

ADDITIONAL CHARACTERISTICS*

Flame retardant	IEC 60332-1-2 • EN 60332-1-2 (cable vertically mounted, length of charred cable ≤ 540 mm)
Fire retardant	IEC 60332-3-24 • EN 60332-3-24 (bunch of cables vertically mounted on a ladder, length of charred cables ≤ 2,5 m)
Halogen free	
Low smoke	IEC 61034-2 • EN 61034-2 (cable light transmittance ≥ 60%)
Low toxicity	IEC 60754-1 • EN 50267-2-1 (halogen acid gas content ≤ 0,5%)
Low corrosivity	IEC 60754-2 • EN 50267-2-3 (LSFH sheath: pH ≥ 4,3 • conductivity ≤ 10µS/mm)

* Applicable only for TE1HZ12AZ1 cable.

DIMENSIONAL CHARACTERISTICS

PE insulation • Al screen • PE • Corrugated Armour • PE – TE1HE2AE

N.º of pairs	Ø 0,9 mm		Ø 1,3 mm		Ø 1,4 mm	
	Diameter (mm)	Weight (kg/km)	Diameter (mm)	Weight (kg/km)	Diameter (mm)	Weight (kg/km)
1	12,4	180	14,4	240	15,4	280
3	17,5	320	19,5	440	24,0	560
5	19,5	420	22,6	610	27,1	770
7	21,2	500	24,4	770	30,6	990
10	24,4	660	29,1	1 020	35,1	1 310
12	26,0	740	30,6	1 170	36,7	1 490
14	27,5	830	32,3	1 320	40,4	1 710
19	30,8	1 040	37,0	1 700	45,9	2 220
25	34,0	1 290	42,3	2 170	50,6	2 810
28	37,2	1 510	---	---	---	---

PE insulation • Al screen • LSHF • Corrugated Armour • LSHF – TE1HZ12AZ1

N.º of pairs	Ø 0,9 mm		Ø 1,3 mm		Ø 1,4 mm	
	Diameter (mm)	Weight (kg/km)	Diameter (mm)	Weight (kg/km)	Diameter (mm)	Weight (kg/km)
1	12,4	220	14,4	290	15,4	330
3	17,5	380	19,5	510	24,0	650
5	19,5	490	22,6	700	27,1	880
7	21,2	590	24,4	870	30,6	1 120
10	24,4	760	29,1	1 150	35,1	1 460
12	26,0	850	30,6	1 300	36,7	1 660
14	27,5	940	32,3	1 460	40,4	1 890
19	30,8	1 180	37,0	1 870	45,9	2 440
25	34,0	1 450	42,3	2 370	50,6	3 070
28	37,2	1 690	---	---	---	---

RAILWAY SIGNALING CABLE

APPLICATION

Cables ranging from 1 to 28 star quads used as control and signalling cables. The sheath offers special protection of the core against rodents. Recommended for duct or direct buried installations.

CABLE DESIGNATION

PE insulation / Jelly / Aluminium screen / PE / Steel armour / PE: TEG1HE2AE

CONSTRUCTION CHARACTERISTICS

Conductor

Solid annealed copper, nominal diameter of 0,9 mm.

Insulation

Solid polyethylene.

Arrangement (formation)

Star-quads.

Core assembly

In layers.

Filling compound

Waterblocking compound, compatible with all the remaining cable components.

Core wrapping

Dielectric tape, helically applied with an overlap.

Shield (screen)

Aluminium tape with copolymer on both sides, applied longitudinally with an overlap.

Inner sheath (jacket)

Black, low density polyethylene (PE).

Armour

Corrugated steel tape applied longitudinally with an overlap.

Oversheath (jacket)

Black, low density polyethylene (PE).

COLOUR AND CABLE MARKING

Black.

Sheath (jacket) will be marked, at regular intervals, with the following information:

<Manufacturer's name> <type of cable> <year> <metric marking>

COLOUR CODE

Quad position in the centre or in the layer	Insulation colour				
	Cond. "a"	Cond. "b"	Cond. "c"	Cond. "d"	
				Centre and even quads	Odd quads
1st (pilot)	Orange	Green	Red	White	Black
2nd, 4rd, 6th, etc.	Yellow	Green	Blue	White	Black
3rd, 5th, 7th, etc	Yellow	Green	Red	White	Black
Last (reference)	Orange	Green	Blue	White	Black



GENERAL AND ELECTRICAL CHARACTERISTICS (20°C)

Maximum Ohmic resistance at 20°C dc(Ω /km)	29,0		
Mutual capacitance at 1 kHz	Average value: 38 ± 3 nF/Km		
	Maximum value: 45 nF/Km		
Resistance unbalance	Maximum individual value: 2,5%		
Minimum insulation resistance at 15°C, 500Vdc	25 000 M Ω x km		
Dielectric strength (3s)	Cond-Cond – 3 kVdc or 2,1 kVac		
	Cond-Screen – 3,5 kVdc or 2,5 kVac		
		Max. Average value ⁽¹⁾	Max. value
Capacitance unbalance (pF/460m, 1 kHz)	Pair-pair:		
	Same quad	35	250
	Adjacent quads	35	250
	Non adjacent quads	----	250
	Pair-ground	320	1 200

(1) Average limits only apply for cables with more than seven quads.

DIMENSIONAL CHARACTERISTICS

PE insulation • Al screen • PE • Corrugated Armour • PE – TEG1HE2AE

N.º of pairs	Ø 0,9 mm	
	Diameter (mm)	Weight (kg/km)
1	13,8	220
3	18,9	400
5	23,0	560
7	24,6	670
10	27,9	890
12	29,5	1000
14	31,0	1110
19	35,7	1430
25	39,5	1780
28	43,8	2080

RAILWAY SIGNALING CABLE

APPLICATION

Cables ranging from 4 to 28 pairs, used as control and signalling cables. Installation is recommended in trenches. The sheath is specially designed to protect the core against inductive interferences.

CABLE DESIGNATION

PE insulation / PVC / Copper screen /armour / PVC: ZPAU

CONSTRUCTION CHARACTERISTICS

Conductor

Solid annealed copper, nominal cross section of 1,0 mm² or 1,5 mm².

Insulation

Solid polyethylene.

Arrangement (formation)

Pairs.

Core assembly

Concentric layers.

Core wrapping

Dielectric tape, helically applied with an overlap.

Inner sheath (jacket)

Black, low density polyethylene (PE).

Induction screen (protection)

One corrugated copper tape, applied longitudinally with an overlap.

Bedding layer (armour bedding)

Polyethylene tapes helically applied with an overlap.

Electromagnetic shield (protection)

Double layer of steel tapes helically applied with a gap not exceeding 50% the tapes' width.

The outer tape will cover the gap left by the inner tape.

Oversheath (jacket)

Black PVC.

COLOUR AND CABLE MARKING

Black. Sheath (jacket) will be marked, at regular intervals, with the following information:

<Manufacturer's name> <type of cable> <year> <metric marking>

COLOUR CODE

For all pairs, conductor A is colorless and conductor B follows the following sequence in each layer until completing the number of pairs of the layer.

Pilot pair	Remaining pairs (The sequence is repeated until completing the number of pairs of the layer)			
Black	Blue	Yellow	Red	Green

In the particular case of the 2 pair cable, stranding is in star quad:

Pair 1: Colorless and black. Pair 2: Yellow and blue.



GENERAL AND ELECTRICAL CHARACTERISTICS (20°C)

Reference standard	NF F 55 698	
Maximum Ohmic resistance at 20°C dc(Ω /km)	1,0 mm ²	18,46
	1,5 mm ²	12,31
Resistance unbalance	Maximum value: 2,5%	
Minimum insulation resistance at 15°C, 500Vdc	5 000 M Ω x km	
Dielectric strength (Vdc, 3s)	Cond-Cond: 4 kV	
	Cond-Screen: 4,5 kV	
Mutual capacitance at 1 kHz	Maximum value: 55 nF/Km	
Capacitance unbalance, pair-pair (pF/500 m, 1000 Hz)	Maximum value for 90% of measured values: 200	
	Maximum value: 400	
Reduction factor, Rk (50Hz)	Inductive voltage (V/km)	Rk
	28	0,75
	32	0,70
	37	0,60
	42	0,50
	47	0,40
	54	0,35
	70	0,30
	80	0,28
	100	0,26
	120	0,25
	170	0,24
225	0,25	

DIMENSIONAL CHARACTERISTICS

N.º of pairs	1 mm ²		1,5 mm ²	
	Diameter (mm)	Weight (kg/km)	Diameter (mm)	Weight (kg/km)
4	21	720	22	650
7	24	920	27	1 150
14	30	1370	33	1 700
21	34	1720	37	2 050
28	38	2000	43	2 360

RAILWAY SIGNALING CABLE

APPLICATION

Cables ranging from 3 to 24 pairs, used as control and signalling cables. The sheath is specially designed to protect the core against inductive interferences. Indicated for installations, indoor or outdoor, protected or not. Can be installed directly buried.

CABLE DESIGNATION

PE insulation / Copper wire screen / PE / Steel tape armour / PE: TEOEAE

PE insulation / Aluminium wire screen / PE / Steel tape armour / PE: TE1REAE

PE insulation / Copper corrugated tape screen / PE / Steel tape armour / PE: TE3HEAE

PE insulation / Copper wire screen / LSHF/ Steel tape armour / LSHF: TEOZ1AZ1

PE insulation / Aluminium wire screen / LSHF / Steel tape armour / LSHF: TE1RZ1AZ1

PE insulation / Copper corrugated tape screen / LSHF / Steel tape armour / LSHF: TE3HZ1AZ1

CONSTRUCTION CHARACTERISTICS

Conductor

Solid annealed copper, nominal diameter of 0,9 mm.

Insulation

Solid polyethylene.

Arrangement (formation)

Pairs.

Core assembly

Concentric layers.

Core wrapping

Dielectric tape, helically applied with an overlap.

Induction screen (protection)

Copper wires helically applied, aluminium wires helically applied or corrugated copper longitudinally applied, depending on the reduction factor requirement.

Inner sheath (jacket)

Black, low density polyethylene (PE) or LSHF – Low Smoke Halogen Free thermoplastic compound.

Electromagnetic shield (protection)

Double layer of steel tapes helically applied.

Oversheath (jacket)

Black, low density polyethylene (PE) or LSHF – Low Smoke Halogen Free thermoplastic compound, fire retardant.

COLOUR AND CABLE MARKING

Black.

Sheath (jacket) will be marked, at regular intervals, with the following information:

<Manufacturer's name> <type of cable> <year> <metric marking>



COLOUR CODE

N.º Pair	Conductor "a"	Conductor "b"	N.º Pair	Conductor "a"	Conductor "b"
1	White	Blue	14	Black	Brown
2	White	Orange	15	Black	Grey
3	White	Green	16	Yellow	Blue
4	White	Brown	17	Yellow	Orange
5	White	Grey	18	Yellow	Green
6	Red	Blue	19	Yellow	Brown
7	Red	Orange	20	Yellow	Grey
8	Red	Green	21	Violet	Blue
9	Red	Brown	22	Violet	Orange
10	Red	Grey	23	Violet	Green
11	Black	Blue	24	Violet	Brown
12	Black	Orange	25	Violet	Grey
13	Black	Green	26	White	Black

GENERAL AND ELECTRICAL CHARACTERISTICS (20°C)

Maximum Ohmic resistance at 20°C dc(Ω/km)	29,0		
Resistance unbalance	Maximum/average value: 1% Maximum individual value: 2%		
Minimum insulation resistance at 15°C, 500Vdc	35 000 MΩ x km		
Dielectric strength (3s)	Cond-Cond – 3 kVdc or 2,1 kVac Cond-Screen – 3,5 kVdc or 2,5 kVac		
Mutual capacitance at 1 kHz	Average value: 52 ± 4 nF/Km Maximum value: 58 nF/Km		
Capacitance unbalance (pF/km, 1 kHz)	Max. Average value	Max. value	
	Pair-pair	45	260
	Pair-ground	650	2625
Reduction factor, Rk – FR=0,1 (50Hz)	Inductive voltage (V/km)		
	FR=0,1	200-500	0,1
	FR=0,3	110-320	0,3

ADDITIONAL CHARACTERISTICS*

Flame retardant	IEC 60332-1-2 • EN 60332-1-2 (cable vertically mounted, length of charred cable ≤ 540 mm)
Fire retardant	IEC 60332-3-24 • EN 60332-3-24 (bunch of cables vertically mounted on a ladder, length of charred cables ≤ 2,5 m)
Halogen free	
Low smoke	IEC 61034-2 • EN 61034-2 (cable light transmittance ≥ 60%)
Low toxicity	IEC 60754-1 • EN 50267-2-1 (halogen acid gas content ≤ 0,5%)
Low corrosivity	IEC 60754-2 • EN 50267-2-3 (LSFH sheath: pH ≥ 4,3 • conductivity ≤ 10µS/mm)

* Applicable only for TEOZ1AZ1, TE1RZ1AZ1, TE3HZ1AZ1 cables.

RAILWAY SIGNALING CABLE**DIMENSIONAL CHARACTERISTICS**

Cables with reduction factor · Pairs · PE insulation · Copper wire screen + armour · PE – TEOEAE

N.º of pairs	Ø 0,9 mm (FR=0,1)		Ø 0,9 mm (FR=0,3)	
	Diameter (mm)	Weight (kg/km)	Diameter (mm)	Weight (kg/km)
3	18,5	780	17,0	480
4	19,5	840	17,5	530
7	21,0	970	19,0	630
10	22,5	1100	21,0	730
14	24,0	1240	22,0	830
20	26,5	1480	24,5	990
24	28,0	1600	25,5	1100

RAILWAY SIGNALING CABLE

APPLICATION

Cables ranging from 3 to 24 pairs, used as control and signalling cables. The sheath is specially designed to protect the core against inductive interferences. Indicated for installations, indoor or outdoor, protected or not. Can be installed directly buried.

CABLE DESIGNATION

PE insulation / Jelly / Copper wire screen / PE / Steel tape armour / PE: TEGOEAE

PE insulation / Jelly / Aluminium wire screen / PE / Steel tape armour / PE: TEG1REAE

CONSTRUCTION CHARACTERISTICS

Conductor

Solid annealed copper, nominal diameter of 0,9 mm.

Insulation

Solid polyethylene.

Arrangement (formation)

Pairs.

Core assembly

Concentric layers.

Filling compound

Waterblocking compound, compatible with all the remaining cable components.

Core wrapping

Dielectric tape, helically applied with an overlap.

Induction screen (protection)

Copper wires helically applied or aluminium wires helically applied, depending on the reduction factor requirement.

Inner sheath (jacket)

Black, low density polyethylene (PE).

Electromagnetic shield (protection)

Double layer of steel tapes helically applied.

Oversheath (jacket)

Black, low density polyethylene (PE).

COLOUR AND CABLE MARKING

Black.

Sheath (jacket) will be marked, at regular intervals, with the following information:

<Manufacturer's name> <type of cable> <year> <metric marking>

COLOUR CODE

N.º Pair	Conductor "a"	Conductor "b"	N.º Pair	Conductor "a"	Conductor "b"
1	White	Blue	5	White	Grey
2	White	Orange	6	Red	Blue
3	White	Green	7	Red	Orange
4	White	Brown	8	Red	Green



We reserve the right to modify, at any time, without any obligation and without prior notice, the specifications and other technical data in this document, which must be confirmed when ordering.



N.º Pair	Conductor "a"	Conductor "b"	N.º Pair	Conductor "a"	Conductor "b"
9	Red	Brown	18	Yellow	Green
10	Red	Grey	19	Yellow	Brown
11	Black	Blue	20	Yellow	Grey
12	Black	Orange	21	Violet	Blue
13	Black	Green	22	Violet	Orange
14	Black	Brown	23	Violet	Green
15	Black	Grey	24	Violet	Brown
16	Yellow	Blue	25	Violet	Grey
17	Yellow	Orange	26	White	Black

GENERAL AND ELECTRICAL CHARACTERISTICS (20°C)

Maximum Ohmic resistance at 20°C dc(Ω /km)	29,0		
Resistance unbalance	Maximum/average value: 1%		
	Maximum individual value: 2%		
Minimum insulation resistance at 15°C, 500Vdc	25 000 M Ω x km		
Dielectric strength (3s)	Cond-Cond – 3 kVdc or 2,1 kVac		
	Cond-Screen – 3,5 kVdc or 2,5 kVac		
Mutual capacitance at 1 kHz	Average value: 52 \pm 4 nF/Km		
	Maximum value: 58 nF/Km		
Capacitance unbalance (pF/km, 1 kHz)	Max. Average value	Max. value	
	Pair-pair	45	260
	Pair-ground	650	2625
Reduction factor, Rk – FR=0,1 (50Hz)	Inductive voltage (V/km)	Max. Rk	
	FR=0,1	200-500	0,1
	FR=0,3	110-320	0,3

DIMENSIONAL CHARACTERISTICS

Cables with reduction factor • Pairs • PE insulation • Copper wire screen + armour • PE – TEGOAEAE

N.º of pairs	Ø 0,9 mm (FR=0,1)		Ø 0,9 mm (FR=0,3)	
	Diameter (mm)	Weight (kg/km)	Diameter (mm)	Weight (kg/km)
3	19,5	850	18,0	560
4	20,5	920	19,0	610
7	22,5	1080	21,0	730
10	24,0	1240	23,0	860
14	27,0	1470	24,5	970
20	29,5	1760	27,5	1200
24	31,0	1890	29,0	1330

APPLICATION

Cables ranging from 3 to 48 star quads, used as control and signalling cables. The sheath is specially designed to protect the core against inductive interferences. Indicated for installations, indoor or outdoor, protected or not. Can be installed directly buried.

CABLE DESIGNATION

PE insulation / Copper wire screen / PE / Steel tape armour / PE: TEOEAE
PE insulation / Aluminium wire screen / PE / Steel tape armour / PE: TE1REAE
PE insulation / Copper corrugated tape screen / PE / Steel tape armour / PE: TE3HEAE
PE insulation / Copper wire screen / LSHF/ Steel tape armour / LSHF: TEOZ1AZ1
PE insulation / Aluminium wire screen / LSHF / Steel tape armour / LSHF: TE1RZ1AZ1
PE insulation / Copper corrugated tape screen / LSHF / Steel tape armour / LSHF: TE3HZ1AZ1

CONSTRUCTION CHARACTERISTICS

Conductor

Solid annealed copper, nominal diameter of 0,9 mm.

Insulation

Solid polyethylene.

Arrangement (formation)

Star-quads.

Core assembly

Concentric layers.

Core wrapping

Dielectric tape, helically applied with an overlap.

Induction screen (protection)

Copper wires helically applied, aluminium wires helically applied or corrugated copper longitudinally applied, depending on the reduction factor requirement.

Inner sheath (jacket)

Black, low density polyethylene (PE) or LSHF – Low Smoke Halogen Free thermoplastic compound.

Electromagnetic shield (protection)

Double layer of steel tapes helically applied.

Oversheath (jacket)

Black, low density polyethylene (PE) or LSHF – Low Smoke Halogen Free thermoplastic compound, fire retardant.

COLOUR AND CABLE MARKING

Black.

Sheath (jacket) will be marked, at regular intervals, with the following information:

<Manufacturer's name> <type of cable> <year> <metric marking>



COLOUR CODE

	Insulation colour				
	Cond. "a"	Cond. "b"	Cond. "c"	Cond. "d"	
Quad position in the centre or in the layer				Centre and even quads	Odd quads
1st (pilot)	Orange	Green	Red	White	Black
2nd, 4rd, 6th, etc.	Yellow	Green	Blue	White	Black
3rd, 5th, 7th, etc	Yellow	Green	Red	White	Black
Last (reference)	Orange	Green	Blue	White	Black

GENERAL AND ELECTRICAL CHARACTERISTICS (20°C)

Maximum Ohmic resistance at 20°C dc(Ω/km)	29,0		
Maximum resistance unbalance	2,5%		
Minimum insulation resistance at 15°C, 500Vdc	35 000 MΩ x km		
Dielectric strength (3s)	Cond-Cond – 3 kVdc or 2,1 kVac Cond-Screen – 3,5 kVdc or 2,5 kVac		
Mutual capacitance at 1 kHz	Average value: 38 ± 3 nF/Km Maximum value: 45 nF/Km		
Capacitance unbalance (pF/460m, 1 kHz)		Max. Average value ⁽¹⁾	Max. value
	Pair-pair:		
	Same quad	35	250
	Adjacent quads	35	250
	Non adjacent quads	----	250
Pair-ground	320	1200	
Reduction factor, Rk – FR=0,1 (50Hz)		Inductive voltage (V/km)	Max. Rk
	FR=0,1	200-500	0,1
	FR=0,3	110-320	0,3

(1) Average limits only apply for cables with more than seven quads.

ADDITIONAL CHARACTERISTICS*

Flame retardant	IEC 60332-1-2 • EN 60332-1-2 (cable vertically mounted, length of charred cable ≤ 540 mm)
Fire retardant	IEC 60332-3-24 • EN 60332-3-24 (bunch of cables vertically mounted on a ladder, length of charred cables ≤ 2,5 m)
Halogen free	
Low smoke	IEC 61034-2 • EN 61034-2 (cable light transmittance ≥ 60%)
Low toxicity	IEC 60754-1 • EN 50267-2-1 (halogen acid gas content ≤ 0,5%)
Low corrosivity	IEC 60754-2 • EN 50267-2-3 (LSFH sheath: pH ≥ 4,3 • conductivity ≤ 10µS/mm)

* Applicable only for TEOZ1AZ1, TE1RZ1AZ1, TE3HZ1AZ1 cables.

RAILWAY SIGNALING CABLE

DIMENSIONAL CHARACTERISTICS

Cables with reduction factor • Quads • PE insulation • Copper screen + armour • PE – TEOEAE

N.º of pairs	Ø 0,9 mm (FR=0,1)		Ø 0,9 mm (FR=0,3)	
	Diameter (mm)	Weight (kg/km)	Diameter (mm)	Weight (kg/km)
3	22,0	1040	20,5	670
5	24,5	1250	23,0	820
7	26,5	1420	24,5	930
10	30,0	1720	27,5	1140
14	33,0	2020	30,5	1380
19	36,5	2400	33,5	1650
27	41,0	2940	38,5	2090
37	46,0	3600	43,5	2600
48	50,5	4260	47,5	3110

RAILWAY SIGNALING CABLE

APPLICATION

Cables ranging from 3 to 48 star quads, used as control and signalling cables. The sheath is specially designed to protect the core against inductive interferences. Indicated for installations, indoor or outdoor, protected or not. Can be installed directly buried.

CABLE DESIGNATION

PE insulation / Jelly / Copper wire screen / PE / Steel tape armour / PE: TEGOAE
PE insulation / Jelly / Aluminium wire screen / PE / Steel tape armour / PE: TEG1REAE

CONSTRUCTION CHARACTERISTICS

Conductor

Solid annealed copper, nominal diameter of 0,9 mm.

Insulation

Solid polyethylene.

Arrangement (formation)

Star-quads.

Core assembly

Concentric layers.

Filling compound

Waterblocking compound, compatible with all the remaining cable components.

Core wrapping

Dielectric tape, helically applied with an overlap.

Induction screen (protection)

Copper wires helically applied or aluminium wires helically applied, depending on the reduction factor requirement.

Inner sheath (jacket)

Black, low density polyethylene (PE).

Electromagnetic shield (protection)

Double layer of steel tapes helically applied.

Oversheath (jacket)

Black, low density polyethylene (PE).

COLOUR AND CABLE MARKING

Black. Sheath (jacket) will be marked, at regular intervals, with the following information:
<Manufacturer's name> <type of cable> <year> <metric marking>

COLOUR CODE

	Insulation colour				
	Cond. "a"	Cond. "b"	Cond. "c"	Cond. "d"	
Quad position in the centre or in the layer				Centre and even quads	Odd quads
1st (pilot)	Orange	Green	Red	White	Black
2nd, 4rd, 6th, etc.	Yellow	Green	Blue	White	Black



We reserve the right to modify, at any time, without any obligation and without prior notice, the specifications and other technical data in this document, which must be confirmed when ordering.



	Insulation colour				
	Cond. "a"	Cond. "b"	Cond. "c"	Cond. "d"	
Quad position in the centre or in the layer				Centre and even quads	Odd quads
3rd, 5th, 7th, etc	Yellow	Green	Red	White	Black
Last (reference)	Orange	Green	Blue	White	Black

GENERAL AND ELECTRICAL CHARACTERISTICS (20°C)

Maximum Ohmic resistance at 20°C dc(Ω/km)	29,0		
Maximum resistance unbalance	2,5%		
Minimum insulation resistance at 15°C, 500Vdc	25 000 MΩ x km		
Dielectric strength (3s)	Cond-Cond – 3 kVdc or 2,1 kVac		
	Cond-Screen – 3,5 kVdc or 2,5 kVac		
Mutual capacitance at 1 kHz	Average value: 38 ± 3 nF/Km		
	Maximum value: 45 nF/Km		
Capacitance unbalance (pF/460m, 1 kHz)		Max. Average value ⁽¹⁾	Max. value
	Pair-pair:		
	Same quad	35	250
	Adjacent quads	35	250
	Non adjacent quads	----	250
Pair-ground	320	1200	
Reduction factor, Rk – FR=0,1 (50Hz)		Inductive voltage (V/km)	Max. Rk
	FR=0,1	200-500	0,1
	FR=0,3	110-320	0,3

(1) Average limits only apply for cables with more than seven quads.

DIMENSIONAL CHARACTERISTICS

Cables with reduction factor • Quads • PE insulation • Copper screen • armour • PE – TEGOAEAE

N.° of pairs	Ø 0,9 mm (FR=0,1)		Ø 0,9 mm (FR=0,3)	
	Diameter (mm)	Weight (kg/km)	Diameter (mm)	Weight (kg/km)
3	24,0	1160	22,0	760
5	28,0	1490	25,0	950
7	29,5	1640	27,0	1100
10	33,0	2040	30,5	1380
14	36,0	2360	33,5	1650
19	39,5	2820	37,5	2030
27	45,0	3520	42,5	2550
37	50,5	4380	48,0	3220
48	55,5	5240	53,0	3890

CONTROL & INSTRUMENTATION CABLES

MULTICORE, OVERALL SCREEN

Unarmoured

- Cu / PVC, PE or XLPE / Al or Copper screen / PVC or LSHF
VHV • FVHV • EHV • FEHV • XHV • FXHV • XHZ1 • FXHZ1
- Cu / LSHF / Al screen / LSHF
Z1HZ1

Armoured

- Cu / PE / Al screen / PE or LSHF / Corrugated Armour / PE or LSHF
E1HE2AE • E1HZ12AZ1

PAIRS, OVERALL SCREEN

Unarmoured

- Cu / PE, PVC or XLPE / Al screen / PVC
EHV • FEHV • VHV • FVHV • XHV • FXHV
- Cu / XLPE / Al screen / LSHF
XHZ1 • FXHZ1

Armoured

- Cu / PVC, PE or XLPE / Al Screen / PVC / STA or SWA / PVC
VHV RV • FVHV RV • VHV AV • FVHV AV • EHV RV • FEHV RV • EHV AV • FEHV AV • XHV RV
FXHV RV • XHV AV • FXHV AV
- Cu / XLPE / Al Screen / LSHF / STA or SWA / LSHF
XHZ1RZ1 • FXHZ1RZ1 • XHZ1AZ1 • FXHZ1AZ1

PAIRS, SCREENED PAIR

Unarmoured

- Cu / PVC, PE or XLPE / Al Screen / Al Screen / PVC
VHIV • FVHIV • VHIV • FVHIV • EHIV • FEHIV • EHIV • FEHIV • XHIV • FXHIV • XHIV • FXHIV
- Cu / XLPE / Al Screen / Al Screen / Al Screen / LSHF
XHIZ1 • FXHIZ1 • XHIZ1 • FXHIZ1

Armoured

- Cu / PVC, PE or XLPE / Al Screen / Al Screen / PVC / STA or SWA / PVC
VHIV RV • FVHIV RV • VHIV AV • FVHIV AV • EHIV RV • FEHIV RV • EHIV AV • FEHIV AV
FXHIV AV • XHIV RV • FXHIV RV • XHIV AV • FXHIV AV
- Cu / XLPE / Al Screen / Al Screen / LSHF / STA or SWA / LSHF
XHIZ1RZ1 • FXHIZ1RZ1 • XHIZ1AZ1 • FXHIZ1AZ1

APPLICATION

Cables for signalling systems, instrumentation and control of electrical mechanisms. Maximum rated voltage 500 V (peak value, not for power supply). Indicated for fixed installations, indoor or outdoor, protected or not.

CABLE DESIGNATION

Cu / PVC / Al or Copper screen / PVC: VHV • FVHV
Cu / PE / Al or Copper screen / PVC: EHV • FEHV
Cu / XLPE / Al or Copper screen / PVC: XHV • FXHV
Cu / XLPE / Al or Copper screen / LSHF: XHZ1 • FXHZ1
F – Flexible

CONSTRUCTION CHARACTERISTICS

Conductor

Rigid (class 2) or flexible (class 5) copper, sizes 0,5 mm²; 1,0 mm² and 1,5 mm², as per IEC 60228.

Insulation

PVC, solid polyethylene or cross-linked polyethylene.

Arrangement (formation)

Multicore, stranded.

Core assembly

Concentric layers.

Core wrapping

Dielectric tape, helically applied with an overlap.

Shield (screen)

Aluminium/polyester tape (9/12,5 µm thickness), applied helically with an overlap. A 0,8 mm diameter copper drain wire is applied under the tape.

Alternatively, a copper tape (0,10 mm thickness), helically applied with an overlap may be used.

Over sheath (jacket)

Extruded PVC or LSHF – Low Smoke Halogen Free compound.

COLOUR AND CABLE MARKING

Grey. Other colours by request.

Sheath (jacket) will be marked, at regular intervals, with the following information:

<Manufacturer's name> <type of cable> <year> <metric marking>



GENERAL AND ELECTRICAL CHARACTERISTICS (20°C)

		0,5 mm ²	1,0 mm ²	1,5 mm ²
Maximum resistance of conductor at 20°C dc(Ω/km)	Class 2	36,0	18,1	12,1
	Class 5	39,0	19,5	13,3
Dielectric strength (60s) – 500 V rating		3 kV _{dc} or 2,0 kV _{ac}		

DIMENSIONAL CHARACTERISTICS

Rigid Cu · PVC · Al screen · PVC – VHV 500V rating

N.º of conductors	0,5 mm ²		1,0 mm ²		1,5 mm ²	
	Diameter (mm)	Weight (kg/km)	Diameter (mm)	Weight (kg/km)	Diameter (mm)	Weight (kg/km)
4	7,5	80	8,5	110	9,5	140
7	9,0	120	10,0	160	11,0	210
9	11,0	150	12,0	200	13,5	260
12	11,5	180	13,0	250	14,5	330
19	13,5	260	15,5	370	17,0	490
27	16,5	360	18,5	510	20,5	670
37	18,5	480	20,5	670	23,0	890
48	21,0	610	23,5	850	26,5	1150
61	23,0	740	26,0	1060	29,0	1430

Flexible Cu · PVC · Al screen · PVC – FVHV 500V rating

N.º of conductors	0,5 mm ²		1,0 mm ²		1,5 mm ²	
	Diameter (mm)	Weight (kg/km)	Diameter (mm)	Weight (kg/km)	Diameter (mm)	Weight (kg/km)
4	7,5	80	9,0	110	9,5	130
7	9,0	120	10,5	160	11,0	200
9	11,0	150	12,5	210	13,5	250
12	11,5	180	13,5	260	14,5	320
19	13,5	260	15,5	380	17,0	470
27	16,0	350	19,0	520	20,5	650
37	18,0	460	21,0	690	23,0	860
48	21,0	580	24,5	880	26,5	1100
61	23,0	700	26,0	1090	29,5	1360

APPLICATION

Cables for signalling systems, instrumentation and control of electrical mechanisms, halogen free. Maximum rated voltage 500 V (peak value, not for power supply). Indicated for fixed installations, indoor or outdoor, protected or not.

CABLE DESIGNATION

Cu / LSHF / Al screen / LSHF: Z1HZ1

CONSTRUCTION CHARACTERISTICS

Conductor

Rigid (class 2) copper, sizes 1,5 mm² and 2,5 mm², as per IEC 60228.

Insulation

Low Smoke Halogen Free compound.

Arrangement (formation)

Multicore, stranded.

Core assembly

Concentric layers.

Core wrapping

Dielectric tape, helically applied with an overlap.

Shield (screen)

Aluminium/polyester tape (9/12,5 µm thickness), applied helically with an overlap.

A 0,8 mm diameter copper drain wire is applied under the tape.

Alternatively, a copper tape helically applied with overlap may be used.

Oversheath (jacket)

LSHF – Low Smoke Halogen Free thermoplastic compound.

COLOUR AND CABLE MARKING

Grey. Other colours by request.

Sheath (jacket) will be marked, at regular intervals, with the following information:

<Manufacturer's name> <type of cable> <year> <metric marking>



GENERAL AND ELECTRICAL CHARACTERISTICS (20°C)

	1,5 mm ²	2,5 mm ²
Maximum resistance of conductor at 20°C dc(Ω/km) Class 2	12,1	7,41
Dielectric strength (60s) – 500 V rating	3 kV _{dc} or 2,0 kV _{ac}	

DIMENSIONAL CHARACTERISTICS

Cu · LSHF · Al screen · LSHF – Z1HZ1 500V rating

N.º of conductors	1,5 mm ²		2,5 mm ²	
	Diameter (mm)	Weight (kg/km)	Diameter (mm)	Weight (kg/km)
4	9,5	130	11,0	190
7	11,0	210	13,5	300
9	13,5	260	16,0	380
12	14,5	330	17,5	490
19	17,0	490	20,5	750
27	20,5	680	24,5	1030
37	23,0	910	28,0	1380
48	26,5	1160	32,0	1780
61	29,0	1450	35,5	2250

APPLICATION

Cables ranging from 4 to 61 conductors used as signaling and control cables. The sheath offers special protection of the core against rodents.

CABLE DESIGNATION

Cu / PE / Al screen / PE / Corrugated Armour / PE: E1HE2AE

Cu / PE / Al screen / LSHF / Corrugated Armour / LSHF: E1HZ12AZ1

CONSTRUCTION CHARACTERISTICS

Conductor

Annealed copper, nominal diameter 1,4 mm.

Insulation

Solid polyethylene.

Arrangement (formation)

Multicore, stranded.

Core assembly

Concentric layers.

Core wrapping

Dielectric tape, helically applied with an overlap.

Shield (screen)

Aluminium tape with copolymer on both sides, applied longitudinally with an overlap.

Inner sheath (jacket)

Black, low density polyethylene (PE) or LSHF – Low Smoke Halogen Free thermoplastic compound.

Armour

Corrugated Steel tape applied longitudinally with an overlap.

Oversheath (jacket)

Black, low density polyethylene (PE) or LSHF – Low Smoke Halogen Free thermoplastic compound, fire retardant.

COLOUR AND CABLE MARKING

Black.

Sheath (jacket) will be marked, at regular intervals, with the following information:

<Manufacturer's name> <type of cable> <year> <metric marking>

COLOUR CODE

Conductors are identified by insulation coloring as per the following color code:

On each layer: 1st black, 2nd white and the remaining conductors will follow the sequence, red, grey, blue, brown, green, yellow.



GENERAL AND ELECTRICAL CHARACTERISTICS (20°C)

Maximum resistance of conductor at 20°C dc(Ω/km)	Average: 11,2 ± 0,5 Maximum value: 12,1
Insulation resistance (MΩ x km, 15°C, 500Vcc.)	Minimum value: 35 000
Dielectric strength (Vcc-3 s)	Cond-Cond: 3 000 Cond-Screen: 4 500

DIMENSIONAL CHARACTERISTICS

N.° of conductors	Diameter (mm)	E1HE2AE Weight (kg/km)	E1HZ12AZ1 Weight (kg/km)
4	13,4	230	280
7	15,4	310	370
9	17,5	380	440
12	17,5	430	500
19	19,5	580	650
27	22,8	770	860
37	25,8	970	1080
48	29,1	1220	1350
61	30,6	1460	1600

APPLICATION

Cables for signalling systems, instrumentation and control of electrical mechanisms grouped in pairs. Maximum rated voltage 500 V (peak value, not for power supply). Indicated for fixed installations, indoor or outdoor, protected or not.

CABLE DESIGNATION

Cu / PVC / Al screen / PVC: VHV • FVHV
Cu / PE / Al screen / PVC: EHV • FEHV
Cu / XLPE / Al screen / PVC: XHV • FXHV
Cu / XLPE / Al screen / LSHF: XHZ1 • FXHZ1
F – Flexible

CONSTRUCTION CHARACTERISTICS

Conductor

Rigid (class 2) or flexible (class 5) copper, sizes 0,5 mm²; 1,0 mm² and 1,5 mm², as per IEC 60228.

Insulation

PVC, solid polyethylene or cross-linked polyethylene.

Arrangement (formation)

Stranded pairs.

Core assembly

Concentric layers.

Core wrapping

Dielectric tape, helically applied with an overlap.

Shield (screen)

Aluminium/polyester tape (9/12,5 µm thickness), applied helically with an overlap.

A 0,5 mm² class 2 copper drain wire is applied under the tape.

Oversheath (jacket)

Extruded PVC or LSHF – Low Smoke Halogen Free thermoplastic compound, fire retardant.

COLOUR AND CABLE MARKING

Grey. Other colours by request.

Sheath (jacket) will be marked, at regular intervals, with the following information:

<Manufacturer's name> <type of cable> <year> <metric marking>



GENERAL AND ELECTRICAL CHARACTERISTICS (20°C)

		0,5 mm ²	1,0 mm ²	1,5 mm ²
Maximum resistance of conductor at 20°C dc(Ω/km)	Class 2	36,7	18,5	12,3
	Class 5	39,8	19,9	13,6
Dielectric strength (60s) – 500 V rating		3 kV _{dc} Or 2,0 kV _{ac}		
Mutual capacitance		Polyolefin: < 150 nF/km PVC: < 250 nF/km		
Capacitance unbalance		500 pF/500m		

DIMENSIONAL CHARACTERISTICS

Rigid Cu · PE · Al screen · PVC – EHV 500V rating

N.º of pairs	0,5 mm ²		1,0 mm ²		1,5 mm ²	
	Diameter (mm)	Weight (kg/km)	Diameter (mm)	Weight (kg/km)	Diameter (mm)	Weight (kg/km)
4	11,0	130	12,5	170	14,0	230
7	13,5	190	15,0	270	16,5	360
9	16,5	250	18,5	350	20,5	470
12	18,0	320	20,0	430	22,0	580
19	21,0	460	24,0	650	26,5	890
27	25,5	640	28,5	900	31,5	1230
37	28,5	840	32,0	1200	36,0	1650

Flexible Cu · PE · Al screen · PVC – FEHV 500V rating

N.º of pairs	0,5 mm ²		1,0 mm ²		1,5 mm ²	
	Diameter (mm)	Weight (kg/km)	Diameter (mm)	Weight (kg/km)	Diameter (mm)	Weight (kg/km)
4	11,0	130	12,5	180	14,0	230
7	13,0	190	15,5	280	17,0	350
9	16,0	250	19,0	360	20,5	450
12	17,5	310	20,5	450	22,5	560
19	21,0	440	24,5	670	26,5	850
27	25,0	610	29,5	930	32,0	1170
37	28,5	790	33,0	1220	36,5	1570

APPLICATION

Armoured cables for signalling systems, instrumentation and control of electrical mechanisms grouped in pairs. Maximum rated voltage 500 V (peak value, not for power supply). Indicated for fixed installations, indoor or outdoor, protected or not. Can be installed directly buried.

CABLE DESIGNATION

Cu / PVC / Al Screen / PVC / STA (Steel tape armour) / PVC: VHVAV • FVHVAV

Cu / PVC / Al Screen / PVC / SWA(Steel wire armour) / PVC: VHVRV • FVHVRV

Cu / PE / Al Screen / PVC / STA (Steel tape armour) / PVC: EHVAV • FEHVAV

Cu / PE / Al Screen / PVC / SWA(Steel wire armour) / PVC: EHVRV • FEHVRV

Cu / XLPE / Al Screen / PVC / STA (Steel tape armour) / PVC: XHVAV • FXHVAV

Cu / XLPE / Al Screen / PVC / SWA(Steel wire armour) / PVC: XHVRV • FXHVRV

Cu / XLPE / Al Screen / LSHF / STA (Steel tape armour) / LSHF: XHZ1AZ1 • FXHZ1AZ1

Cu / XLPE / Al Screen / LSHF / SWA(Steel wire armour) / LSHF: XHZ1RZ1 • FXHZ1RZ1

F – Flexible

CONSTRUCTION CHARACTERISTICS

Conductor

Rigid (class 2) or flexible (class 5) copper, sizes 0,5 mm²; 1,0 mm² and 1,5 mm², as per IEC 60228.

Insulation

PVC, solid polyethylene or cross-linked polyethylene.

Arrangement (formation)

Stranded pairs.

Core assembly

Concentric layers.

Core wrapping

Dielectric tape, helically applied with an overlap.

Shield (screen)

Aluminium/polyester tape (9/12,5 µm thickness), applied helically with an overlap.

A 0,5 mm² class 2 copper drain wire is applied under the tape.

Inner sheath (jacket)

Extruded PVC or LSHF – Low Smoke Halogen Free thermoplastic compound.

Armour

Two steel tapes armour or galvanised steel wire armour, helically applied.

Oversheath (jacket)

Extruded PVC or LSHF – Low Smoke Halogen Free thermoplastic compound.

COLOUR AND CABLE MARKING

Grey. Other colours by request.

Sheath (jacket) will be marked, at regular intervals, with the following information:

<Manufacturer's name> <type of cable> <year> <metric marking>



GENERAL AND ELECTRICAL CHARACTERISTICS (20°C)

		0,5 mm ²	1,0 mm ²	1,5 mm ²
Maximum resistance of conductor at 20°C dc(Ω/km)	Class 2	36,7	18,5	12,3
	Class 5	39,8	19,9	13,6
Dielectric strength (60s) – 500 V rating		3 kV _{dc} Or 2,0 kV _{ac}		
Mutual capacitance		Polyolefin: < 150 nF/km PVC: < 250 nF/km		
Capacitance unbalance		500 pF/500m		

DIMENSIONAL CHARACTERISTICS

Rigid Cu · PE · Al screen · PVC · SWA · PVC – EHVRV 500V rating

N.º of pairs	0,5 mm ²		1,0 mm ²		1,5 mm ²	
	Diameter (mm)	Weight (kg/km)	Diameter (mm)	Weight (kg/km)	Diameter (mm)	Weight (kg/km)
4	15,5	420	17,0	480	18,0	570
7	17,5	520	19,5	630	21,0	750
9	20,5	650	22,5	780	25,5	1130
12	22,0	730	25,0	1090	27,5	1310
19	26,0	1140	29,0	1400	31,5	1720
27	30,5	1440	33,5	1790	37,5	2450
37	33,5	1730	37,5	2200	42,0	3050

Flexible Cu · PE · Al screen · PVC · SWA · PVC – FEHVRV 500V rating

N.º of pairs	0,5 mm ²		1,0 mm ²		1,5 mm ²	
	Diameter (mm)	Weight (kg/km)	Diameter (mm)	Weight (kg/km)	Diameter (mm)	Weight (kg/km)
4	15,5	410	17,0	490	18,5	570
7	17,5	520	20,0	650	21,0	740
9	20,5	630	23,0	790	26,0	1120
12	22,0	720	25,5	1110	27,5	1290
19	26,0	1110	29,5	1440	31,5	1690
27	30,0	1400	34,5	1840	38,0	2390
37	33,5	1680	38,0	2250	42,5	2990

APPLICATION

Cables for signalling systems, instrumentation and control of electrical mechanisms, grouped in individual shielded pairs. Maximum rated voltage 500 V (peak value, not for power supply). Indicated for fixed installations, indoor or outdoor, protected or not.

CABLE DESIGNATION

Cu / PVC / Al Screen / Al Screen / PVC: VHIV • FVHIV
Cu / PE / Al Screen / Al Screen / PVC: EHIV • FEHIV
Cu / XLPE / Al Screen / Al Screen / PVC: XHIV • FXHIV
Cu / XLPE / Al Screen / Al Screen / LSHF: XHIZ1 • FXHIZ1
F – Flexible

CONSTRUCTION CHARACTERISTICS

Conductor

Rigid (class 2) or flexible (class 5) copper, sizes 0,5 mm²; 1,0 mm² and 1,5 mm², as per IEC 60228.

Insulation

PVC, solid polyethylene or cross-linked polyethylene.

Arrangement (formation)

Stranded pairs.

Shield (pair)

Aluminium/polyester tape (9/12,5 µm thickness), applied helically with an overlap.
A 0,5 mm² class 2 copper drain wire is applied under the tape.

Core assembly

Concentric layers.

Core wrapping

Dielectric tape, helically applied with an overlap.

Shield (screen)

Aluminium/polyester tape (9/12,5 µm thickness), applied helically with an overlap.
A 0,5 mm² class 2 copper drain wire is applied under the tape.

Oversheath (jacket)

Extruded PVC or LSHF – Low Smoke Halogen Free thermoplastic compound, fire retardant.

COLOUR AND CABLE MARKING

Grey. Other colours by request.

Sheath (jacket) will be marked, at regular intervals, with the following information:

<Manufacturer's name> <type of cable> <year> <metric marking>



GENERAL AND ELECTRICAL CHARACTERISTICS (20°C)

		0,5 mm ²	1,0 mm ²	1,5 mm ²
Maximum resistance of conductor at 20°C dc(Ω/km)	Class 2	36,7	18,5	12,3
	Class 5	39,8	19,9	13,6
Dielectric strength (60s) – 500 V rating		3 kV _{dc} Or 2,0 kV _{ac}		
Mutual capacitance		Polyolefin: < 150 nF/km PVC: < 250 nF/km		
Capacitance unbalance		500 pF/500m		

DIMENSIONAL CHARACTERISTICS

Rigid Cu • XLPE • Al screen • Al screen • PVC – XHIV 500V rating

N.º of pairs	0,5 mm ²		1,0 mm ²		1,5 mm ²	
	Diameter (mm)	Weight (kg/km)	Diameter (mm)	Weight (kg/km)	Diameter (mm)	Weight (kg/km)
4	12,5	140	14,0	190	15,0	240
7	15,0	210	17,0	290	18,5	370
9	18,5	270	20,5	380	23,0	500
12	20,0	340	22,5	480	25,0	630
19	23,5	490	26,5	690	29,5	930
27	28,5	670	32,0	970	36,0	1300
37	32,5	900	36,5	1270	40,5	1740

Flexible Cu • XLPE • Al screen • Al screen • PVC – FXHIV 500V rating

N.º of pairs	0,5 mm ²		1,0 mm ²		1,5 mm ²	
	Diameter (mm)	Weight (kg/km)	Diameter (mm)	Weight (kg/km)	Diameter (mm)	Weight (kg/km)
4	12,5	140	14,5	200	15,5	240
7	15,0	210	17,0	300	18,5	360
9	18,5	270	21,0	390	23,0	480
12	20,0	330	23,0	490	25,0	610
19	23,5	470	27,5	710	30,0	890
27	28,5	650	33,0	990	36,5	1240
37	32,0	850	37,5	1300	41,0	1650

APPLICATION

Armoured cables for signalling systems, instrumentation and control of electrical mechanisms, grouped in individual shielded pairs. Maximum rated voltage 500 V (peak value, not for power supply). Indicated for fixed installations, indoor or outdoor, protected or not. Can be installed directly buried.

CABLE DESIGNATION

Cu / PVC / Al Screen / Al Screen / PVC / STA (Steel tape armour) / PVC: VHIVAV • FVHIVAV
Cu / PVC / Al Screen / Al Screen / PVC / SWA(Steel wire armour) / PVC: VHIVRV • FVHIVRV
Cu / PE / Al Screen / Al Screen / PVC / STA (Steel tape armour) / PVC: EHIVAV • FEHIVAV
Cu / PE / Al Screen / Al Screen / PVC / SWA(Steel wire armour) / PVC: EHIVRV • FEHIVRV
Cu / XLPE / Al Screen / Al Screen / PVC / STA (Steel tape armour) / PVC: XHIVAV • FXHIVAV
Cu / XLPE / Al Screen / Al Screen / PVC / SWA(Steel wire armour) / PVC: XHIVRV • FXHIVRV
Cu / XLPE / Al Screen / Al Screen / LSHF / STA (Steel tape armour) / LSHF: XHIZ1AZ1 • FXHIZ1AZ1
Cu / XLPE / Al Screen / Al Screen / LSHF / SWA(Steel wire armour) / LSHF: XHIZ1RZ1 • FXHIZ1RZ1
F – Flexible

CONSTRUCTION CHARACTERISTICS

Conductor

Rigid (class 2) or flexible (class 5) copper, sizes 0,5 mm²; 1,0 mm² and 1,5 mm², as per IEC 60228.

Insulation

PVC, solid polyethylene or cross-linked polyethylene.

Arrangement (formation)

Stranded pairs.

Shield (pair)

Aluminium/polyester tape (9/12,5 µm thickness), applied helically with an overlap.

A 0,5 mm² class 2 copper drain wire is applied under the tape.

Core assembly

Concentric layers.

Core wrapping

Dielectric tape, helically applied with an overlap.

Shield (screen)

Aluminium/polyester tape (9/12,5 µm thickness), applied helically with an overlap.

A 0,5 mm² class 2 copper drain wire is applied under the tape.

Inner sheath (jacket)

Extruded PVC or LSHF – Low Smoke Halogen Free thermoplastic compound, fire retardant.

Armour

Double steel tape armour or galvanised steel wire armour, helically applied.

Oversheath (jacket)

Extruded PVC or LSHF – Low Smoke Halogen Free thermoplastic compound, fire retardant.

COLOUR AND CABLE MARKING

Grey. Other colours by request.

Sheath (jacket) will be marked, at regular intervals, with the following information:

<Manufacturer's name> <type of cable> <year> <metric marking>



We reserve the right to modify, at any time, without any obligation and without prior notice, the specifications and other technical data in this document, which must be confirmed when ordering.



GENERAL AND ELECTRICAL CHARACTERISTICS (20°C)

	0,5 mm ²	1,0 mm ²	1,5 mm ²
Maximum resistance of conductor at 20°C dc(Ω/km)			
Class 2	36,7	18,5	12,3
Class 5	39,8	19,9	13,6
Dielectric strength (60s) – 500 V rating	3 kV _{dc} or 2,0 kV _{ac}		
Mutual capacitance	Polyolefin: < 150 nF/km PVC: < 250 nF/km		
Capacitance unbalance	500 pF/500m		

DIMENSIONAL CHARACTERISTICS

Rigid Cu · XLPE · Al screen · Al screen · PVC · SWA · PVC – XHIVRV 500V rating

N.º of pairs	0,5 mm ²		1,0 mm ²		1,5 mm ²	
	Diameter (mm)	Weight (kg/km)	Diameter (mm)	Weight (kg/km)	Diameter (mm)	Weight (kg/km)
4	17,0	460	18,5	540	19,5	610
7	19,5	580	21,0	690	23,5	990
9	23,5	890	26,0	1060	28,0	1220
12	25,0	990	27,5	1200	30,0	1420
19	29,0	1250	31,5	1530	34,5	1850
27	33,5	1580	38,0	2170	42,0	2680
37	38,0	2120	42,5	2690	47,0	3590

Flexible Cu · XLPE · Al screen · Al screen · PVC · SWA · PVC – FXHIVRV 500V rating

N.º of pairs	0,5 mm ²		1,0 mm ²		1,5 mm ²	
	Diameter (mm)	Weight (kg/km)	Diameter (mm)	Weight (kg/km)	Diameter (mm)	Weight (kg/km)
4	16,5	450	18,5	550	20,0	610
7	19,5	570	21,5	700	24,0	980
9	23,5	870	26,5	1080	28,5	1220
12	25,0	980	28,0	1220	30,5	1410
19	28,5	1220	32,5	1570	35,0	1820
27	33,5	1540	38,5	2230	42,5	2640
37	38,0	2060	43,5	2740	47,5	3540

OPTICAL FIBRE CABLES

Unarmoured

- Unitube – TOU ZvE
- Unitube flame retardant – TOU ZvZ1
- Unitube anti-rodent – TOU ZrE
- Unitube anti-rodent, flame retardant – TOU ZrZ1
- Multitube – TON ZvE
- Multitube flame retardant – TON ZvZ1
- Multitube anti-rodent – TON ZrE
- Multitube anti-rodent, flame retardant – TON ZrZ1
- Multitube double jacket – TON EZaE • PKP
- Multitube double jacket, fire retardant – TON Z1ZaZ1 • TKT

Armoured

- Unitube – TOU ZvE2AE
- Unitube fire retardant – TOU ZvZ12AZ1
- Multitube – TON ZvE2AE
- Multitube fire retardant – TON ZvZ12AZ1
- Multitube – TON Zv2AE
- Multitube double jacket, jelly filled – PESP-DR • fire retardant TEST-DR
- Multitube double jacket, jelly filled, tensile reinforced – PKESP-DR • fire retardant TEST-DR

Aerial

- TON ES – 8 figure short span
- ADSS – short span
- ADSS – medium span

APPLICATION

Unitube cable, loose type, non-metallic, low dimensions, lightweight, watertight.
Designed for indoor/outdoor applications in ducts. Cable installation by pulling or blowing.
Easy handling and installation.

CONSTRUCTION CHARACTERISTICS

Optical fibres (at choice)

Single-mode (Dispersion unshifted) – IEC 60793-2 and ITU-T Rec. G.652.

Single-mode NZD – ITU-T Rec. G.655.

Multi-mode type 50/125 μm – IEC 60793-2 (A1.a) and ITU-T Rec. G.651.

Multi-mode type 62,5/125 μm – IEC 60793-2 (A1.b).

Loose Tube

PBT – tube with optical fibres and filled with gel.

Mechanical reinforcement

Glass fibre yarns.

Ripcord

Oversheath

Polyethylene.

COLOUR AND CABLE MARKING

Black.

Oversheath marked at regular intervals with the following information:

<CABELTE> <type of cable> <composition> <year of manufacture> <metric marking>

FIBRES IDENTIFICATION

1 · White	2 · Red	3 · Green	4 · Blue
5 · Black	6 · Yellow	7 · Orange	8 · Grey
9 · Brown	10 · Rose	11 · Violet	12 · Turquoise
13 · White / Black	14 · Yellow / Black	15 · Orange / Black	16 · Red / Black



MECHANICAL AND DIMENSIONAL CHARACTERISTICS

Fibres count per cable	Fibres per tube	Cable diameter (mm)	Cable weight (kg/km)	Max. pulling force		Mechanical resistance		Minimum bending radius	
				Installed (N)	In service (N)	Crush (N/cm)	Impact (J)	Installed (mm)	In service (mm)
2	2	6,0	30	550	200	100	0,5	110	85
4	4	6,0	30	550	200	100	0,5	110	85
6	6	6,0	30	550	200	100	0,5	110	85
8	8	6,0	30	550	200	100	0,5	110	85
12	12	6,0	30	550	200	100	0,5	110	85
16	16	6,5	35	700	250	100	0,5	120	90

Temperature: Storage and transport: - 10°C up to 60°C.

Temperature: Operation: - 20°C up to 60°C.

OPTICAL FIBRE CABLES

APPLICATION

Unitube cable, loose type, non-metallic, low dimensions, lightweight, flame retardant and with a LSHF overshooth. Designed for indoor/outdoor applications in ducts. Cable installation by pulling or blowing. Easy handling and installation.

CONSTRUCTION CHARACTERISTICS

Optical fibres (at choice)

Single-mode (Dispersion unshifted) – IEC 60793-2 and ITU-T Rec. G.652.

Single-mode NZD – ITU-T Rec. G.655.

Multi-mode type 50/125 μm – IEC 60793-2 (A1.a) and ITU-T Rec. G.651.

Multi-mode type 62,5/125 μm – IEC 60793-2 (A1.b).

Loose Tube

PBT – tube with optical fibres and filled with gel.

Mechanical reinforcement

Glass fibre yarns.

Ripcord

Oversheath

LSHF – Low Smoke Halogen Free thermoplastic compound, flame retardant.

COLOUR AND CABLE MARKING

Black.

Oversheath marked at regular intervals with the following information:

<CABELTE> <type of cable> <composition> <year of manufacture> <metric marking>

FIBRES IDENTIFICATION

1 · White	2 · Red	3 · Green	4 · Blue
5 · Black	6 · Yellow	7 · Orange	8 · Grey
9 · Brown	10 · Rose	11 · Violet	12 · Turquoise
13 · White / Black	14 · Yellow / Black	15 · Orange / Black	16 · Red / Black

GENERAL CHARACTERISTIC

S

Flame retardant

IEC 60332-1-2 • EN 60332-1-2 (cable vertically mounted, length of charred cable ≤ 540 mm)

Halogen free

Low smoke

IEC 61034-2 • EN 61034-2 (cable light transmittance ≥ 60%)

Low toxicity

IEC 60754-1 • EN 50267-2-1 (halogen acid gas content ≤ 0,5%)

Low corrosivity

IEC 60754-2 • EN 50267-2-3 (pH ≥ 4,3 • conductivity ≤ 10μS/mm)



MECHANICAL AND DIMENSIONAL CHARACTERISTICS

Fibres count per cable	Fibres per tube	Cable diameter (mm)	Cable weight (kg/km)	Max. pulling force		Mechanical resistance		Minimum bending radius	
				Installed (N)	In service (N)	Crush (N/cm)	Impact (J)	Installed (mm)	In service (mm)
4	4	6,0	40	700	250	100	0,5	110	85
6	6	6,0	40	700	250	100	0,5	110	85
8	8	6,0	40	700	250	100	0,5	110	85
12	12	6,0	40	700	250	100	0,5	110	85
16	16	6,5	45	800	300	100	0,5	120	90

Temperature: Storage and transport: - 10°C up to 60°C.

Temperature: Operation: - 20°C up to 60°C.

OPTICAL FIBRE CABLES

APPLICATION

Unitube cable, loose type, non-metallic, low dimensions, lightweight.

Designed for indoor/outdoor applications, in duct installations in environments with presence of rodents.

Cable installation by pulling or blowing. Easy handling and installation.

CONSTRUCTION CHARACTERISTICS

Optical fibres (at choice)

Single-mode (Dispersion unshifted) – IEC 60793-2 and ITU-T Rec. G.652.

Single-mode NZD – ITU-T Rec. G.655.

Multi-mode type 50/125 μm – IEC 60793-2 (A1.a) and ITU-T Rec. G.651.

Multi-mode type 62,5/125 μm – IEC 60793-2 (A1.b).

Loose Tube

PBT – tube with optical fibres and filled with gel.

Mechanical reinforcement

Compacted layer of glass yarns. Also provide resistance to rodents.

Ripcord

Oversheath

Polyethylene.

COLOUR AND CABLE MARKING

Black.

Oversheath marked at regular intervals with the following information:

<CABELTE> <type of cable> <composition> <year of manufacture> <metric marking>

FIBRES IDENTIFICATION

1 · White	2 · Red	3 · Green	4 · Blue
5 · Black	6 · Yellow	7 · Orange	8 · Grey
9 · Brown	10 · Rose	11 · Violet	12 · Turquoise
13 · White / Black	14 · Yellow / Black	15 · Orange / Black	16 · Red / Black



MECHANICAL AND DIMENSIONAL CHARACTERISTICS

Fibres count per cable	Fibres per tube	Cable diameter (mm)	Cable weight (kg/km)	Max. pulling force		Mechanical resistance		Minimum bending radius	
				Installed (N)	In service (N)	Crush (N/cm)	Impact (J)	Installed (mm)	In service (mm)
4	4	6,0	40	1 000	350	100	0,5	110	85
6	6	6,0	40	1 000	350	100	0,5	110	85
8	8	6,0	40	1 000	350	100	0,5	110	85
12	12	6,0	40	1 000	350	100	0,5	110	85
16	16	6,5	45	1 100	400	100	0,5	120	90

Temperature: Storage and transport: - 10°C up to 60°C.
Temperature: Operation: - 20°C up to 60°C.

OPTICAL FIBRE CABLES

APPLICATION

Unitube cable, loose type, non-metallic, low dimensions, lightweight, flame retardant and with a LSHF over-sheath. Designed for indoor/outdoor applications in duct installation in environments with presence of rodents. Cable installation by pulling or blowing. Easy handling and installation.

CONSTRUCTION CHARACTERISTICS

Optical fibres (at choice)

Single-mode (Dispersion unshifted) – IEC 60793-2 and ITU-T Rec. G.652

Single-mode NZD – ITU-T Rec. G.655

Multi-mode type 50/125 μm – IEC 60793-2 (A1.a) and ITU-T Rec. G.651

Multi-mode type 62,5/125 μm – IEC 60793-2 (A1.b)

Loose Tube

PBT – tube with optical fibres and filled with gel.

Mechanical reinforcement

Compacted layer of glass yarns. Also provide resistance to rodents.

Ripcord

Oversheath

LSHF – Low Smoke Halogen Free thermoplastic compound, flame retardant.

COLOUR AND CABLE MARKING

Black.

Oversheath marked at regular intervals with the following information:

<CABELTE> <type of cable> <composition> <year of manufacture> <metric marking>

FIBRES IDENTIFICATION

1 · White	2 · Red	3 · Green	4 · Blue
5 · Black	6 · Yellow	7 · Orange	8 · Grey
9 · Brown	10 · Rose	11 · Violet	12 · Turquoise
13 · White / Black	14 · Yellow / Black	15 · Orange / Black	16 · Red / Black

GENERAL CHARACTERISTICS

Flame retardant	IEC 60332-1-2 • EN 60332-1-2 (cable vertically mounted, length of charred cable \leq 540 mm)
Halogen free	
Low smoke	IEC 61034-2 • EN 61034-2 (cable light transmittance \geq 60%)
Low toxicity	IEC 60754-1 • EN 50267-2-1 (halogen acid gas content \leq 0,5%)
Low corrosivity	IEC 60754-2 • EN 50267-2-3 (pH \geq 4,3 • conductivity \leq 10 $\mu\text{S}/\text{mm}$)



MECHANICAL AND DIMENSIONAL CHARACTERISTICS

Fibres count per cable	Fibres per tube	Cable diameter (mm)	Cable weight (kg/km)	Max. pulling force		Mechanical resistance		Minimum bending radius	
				Installed (N)	In service (N)	Crush (N/cm)	Impact (J)	Installed (mm)	In service (mm)
4	4	6,0	50	1 000	350	100	0,5	110	85
6	6	6,0	50	1 000	350	100	0,5	110	85
8	8	6,0	50	1 000	350	100	0,5	110	85
12	12	6,0	50	1 000	350	100	0,5	110	85
16	16	6,5	55	1 100	400	100	0,5	120	90

Temperature: Storage and transport: - 10°C up to 60°C.

Temperature: Operation: - 20°C up to 60°C.

OPTICAL FIBRE CABLES

APPLICATION

Multitube cable, loose type, non-metallic, dry core, low dimensions, lightweight, watertight. Designed for indoor/outdoor applications in ducts. Cable installation by pulling or blowing. Easy handling and installation.

CONSTRUCTION CHARACTERISTICS

Optical fibres (at choice)

Single-mode (Dispersion unshifted) – IEC 60793-2 and ITU-T Rec. G.652.

Single-mode NZD – ITU-T Rec. G.655.

Multi-mode type 50/125 µm – IEC 60793-2 (A1.a) and ITU-T Rec. G.651.

Multi-mode type 62,5/125 µm – IEC 60793-2 (A1.b).

Central strength member

Glass fibre reinforced plastic rod (FRP).

Loose Tubes

PBT – tube with optical fibres and filled with gel.

Core watertightness

Dry – waterblocking swelling tape and yarns.

Mechanical reinforcement

Glass fibre yarns.

Ripcord

Oversheath

Polyethylene.

COLOUR AND CABLE MARKING

Black.

Oversheath marked at regular intervals with the following information:

<CABELTE> <type of cable> <composition> <year of manufacture> <metric marking>

FIBRES IDENTIFICATION

Fibres colour code inside tube

1 · White	2 · Red	3 · Green	4 · Blue
5 · Black	6 · Yellow	7 · Orange	8 · Grey
9 · Brown	10 · Rose	11 · Violet	12 · Turquoise

Colour of filling elements

Black

Tubes colour code

Up to 12 tubes

1 · Red	2 up to 11 · Natural	12 · Green
---------	----------------------	------------

16 tubes

1st jacket	White	Red	Blue	Green
2nd jacket	3 White	3 Red	3 Blue	3 Green



We reserve the right to modify, at any time, without any obligation and without prior notice, the specifications and other technical data in this document, which must be confirmed when ordering.



Tubes colour code

18 tubes

1st jacket	2 White	2 Red	2 Blue	
2nd jacket	3 White	3 Red	3 Blue	3 Green

MECHANICAL AND DIMENSIONAL CHARACTERISTICS

Fibres count per cable	N.° of elements	Fibres per tube	Cable diameter (mm)	Cable weight (kg/km)	Max. Pulling force		Mechanical resistance		Minimum bending radius	
					Installed (N)	In service (N)	Crush (N/cm)	Impact (J)	Installed (mm)	In service (mm)
12	5	6	10,0	70	1 150	650	300	1	180	140
24	5	6	10,0	70	1 150	650	300	1	180	140
24	5	8	10,0	70	1 150	650	300	1	180	140
24	5	12	10,5	75	1 350	750	300	1	190	145
32	5	8	10,0	70	1 150	650	300	1	180	140
36	6	6	10,0	75	1 250	650	300	1	180	140
36	5	12	10,5	75	1 350	750	300	1	190	145
48	6	8	10,0	75	1 250	650	300	1	180	140
48	5	12	10,5	75	1 350	750	300	1	190	145
60	5	12	10,5	75	1 350	750	300	1	190	145
64	8	8	12,0	105	1 550	800	300	1	215	170
72	9	8	12,5	115	1 900	950	300	1	225	175
72	6	12	11,0	85	1 750	850	300	1	198	154
96	12	8	14,5	160	2 450	1000	300	1	260	205
96	8	12	12,5	115	1 750	950	300	1	225	175
120	10	12	14,0	145	2 250	1 150	300	1	250	195
128	16	8	15,0	170	2 550	1 050	300	1	270	210
144	18	8	15,0	170	2 550	1 050	300	1	270	210
144	12	12	15,5	180	2 850	1 400	300	1	280	215

Temperature: Storage and transport: - 10°C up to 60°C.

Temperature: Operation: - 20°C up to 60°C.

OPTICAL FIBRE CABLES

APPLICATION

Multitube cable, loose type, non-metallic, dry core, low dimensions, lightweight, flame retardant and with a LSHF oversheath. Designed for indoor/outdoor applications in duct installation. Cable installation by pulling or blowing. Easy handling and installation.

CONSTRUCTION CHARACTERISTICS

Optical fibres (at choice)

Single-mode (Dispersion unshifted) – IEC 60793-2 and ITU-T Rec. G.652.

Single-mode NZD – ITU-T Rec. G.655.

Multi-mode type 50/125 μm – IEC 60793-2 (A1.a) and ITU-T Rec. G.651.

Multi-mode type 62,5/125 μm – IEC 60793-2 (A1.b).

Central strength member

Glass fibre reinforced plastic rod (FRP).

Loose Tubes

PBT – tube with optical fibres and filled with gel.

Core watertightness

Dry – waterblocking swelling tape and yarns.

Mechanical reinforcement

Glass fibre yarns.

Ripcord

Oversheath

LSHF – Low Smoke Halogen Free thermoplastic compound, flame retardant.

COLOUR AND CABLE MARKING

Black. Oversheath marked at regular intervals with the following information:

<CABELTE> <type of cable> <composition> <year of manufacture> <metric marking>

FIBRES IDENTIFICATION

Fibres colour code inside tube

1 · White	2 · Red	3 · Green	4 · Blue
5 · Black	6 · Yellow	7 · Orange	8 · Grey
9 · Brown	10 · Rose	11 · Violet	12 · Turquoise

Colour of filling elements

Black

Tubes colour code

Up to 12 tubes

1 · Red	2 up to 11 · Natural	12 · Green
---------	----------------------	------------

16 tubes

1st jacket	White	Red	Blue	Green
2nd jacket	3 White	3 Red	3 Blue	3 Green



Tubes colour code

18 tubes

1st jacket	2 White	2 Red	2 Blue	
2nd jacket	3 White	3 Red	3 Blue	3 Green

GENERAL CHARACTERISTICS

Flame retardant	IEC 60332-1-2 • EN 60332-1-2 (cable vertically mounted, length of charred cable ≤ 540 mm)
Oversheath halogen free	
Low toxicity	IEC 60754-1 • EN 50267-2-1 (halogen acid gas content ≤ 0,5%)
Low corrosivity	IEC 60754-2 • EN 50267-2-2 (pH ≥ 4,3 • conductivity ≤ 10μS/mm)

MECHANICAL AND DIMENSIONAL CHARACTERISTICS

Fibres count per cable	N.º of elements	Fibres per tube	Cable diameter (mm)	Cable weight (kg/km)	Max. Pulling force		Mechanical resistance		Minimum bending radius	
					Installed (N)	In service (N)	Crush (N/cm)	Impact (J)	Installed (mm)	In service (mm)
24	5	6	10,0	90	1 400	850	300	1	180	140
24	5	8	10,0	90	1 400	850	300	1	180	140
24	5	12	10,5	100	1 550	1 000	300	1	190	145
32	5	8	10,0	90	1 400	850	300	1	180	140
36	6	6	10,0	100	1 500	850	300	1	180	140
36	5	12	10,5	100	1 550	1 000	300	1	190	145
48	6	8	10,0	100	1 500	850	300	1	180	140
48	5	12	10,5	100	1 550	1 000	300	1	190	145
60	5	12	10,5	100	1 550	1 000	300	1	190	145
64	8	8	12,0	135	2 100	1 250	300	1	215	170
72	9	8	12,5	150	2 250	1 050	300	1	225	175
72	6	12	11,0	110	1 750	850	300	1	198	154
96	12	8	14,5	205	3 100	1 200	300	1	260	205
96	8	12	12,5	150	2 300	1 200	300	1	225	175
120	10	12	14,0	180	2 750	1 450	300	1	250	195
128	16	8	15,0	210	3 200	1 350	300	1	270	210
144	18	8	15,0	210	3 200	1 350	300	1	270	210
144	12	12	15,5	225	3 400	1 650	300	1	280	215

Temperature: Storage and transport: - 10°C up to 60°C.

Temperature: Operation: - 20°C up to 60°C.

OPTICAL FIBRE CABLES

APPLICATION

Multitube cable, loose type, non-metallic, dry core, low dimensions, lightweight, watertight. Designed for indoor/outdoor applications, in duct installations in environments with presence of rodents. Cable installation by pulling or blowing. Easy handling and installation.

CONSTRUCTION CHARACTERISTICS

Optical fibres (at choice)

Single-mode (Dispersion unshifted) – IEC 60793-2 and ITU-T Rec. G.652.

Single-mode NZD – ITU-T Rec. G.655.

Multi-mode type 50/125 μm – IEC 60793-2 (A1.a) and ITU-T Rec. G.651.

Multi-mode type 62,5/125 μm – IEC 60793-2 (A1.b).

Central strength member

Glass fibre reinforced plastic rod (FRP).

Loose Tubes

PBT – tube with optical fibres and filled with gel.

Core watertightness

Dry – waterblocking swelling tape and yarns.

Mechanical reinforcement

Glass fibre yarns.

Ripcord

Oversheath

Polyethylene.

COLOUR AND CABLE MARKING

Black. Oversheath marked at regular intervals with the following information:

CABELTE <tipo de cable> <composición> <año de fabricación> <marcado métrico>

FIBRES IDENTIFICATION

Fibres colour code inside tube

1 · White	2 · Red	3 · Green	4 · Blue
5 · Black	6 · Yellow	7 · Orange	8 · Grey
9 · Brown	10 · Rose	11 · Violet	12 · Turquoise
13 · White / Black	14 · Yellow / Black	15 · Orange / Black	16 · Red / Black

Colour of filling elements

Black

Tubes colour code

Up to 12 tubes

1 · Red	2 up to 11 · Natural	12 · Green
---------	----------------------	------------

16 tubes

1st jacket	White	Red	Blue	Green
2nd jacket	3 White	3 Red	3 Blue	3 Green



We reserve the right to modify, at any time, without any obligation and without prior notice, the specifications and other technical data in this document, which must be confirmed when ordering.



Tubes colour code

18 tubes

1st jacket	2 White	2 Red	2 Blue	
2nd jacket	3 White	3 Red	3 Blue	3 Green

MECHANICAL AND DIMENSIONAL CHARACTERISTICS

Fibres count per cable	N.° of elements	Fibres per tube	Cable diameter (mm)	Cable weight (kg/km)	Max. Pulling force		Mechanical resistance		Minimum bending radius	
					Installed (N)	In service (N)	Crush (N/cm)	Impact (J)	Installed (mm)	In service (mm)
24	5	6	10,0	90	3500	1850	300	1	180	140
24	5	8	10,0	90	3500	1850	300	1	180	140
24	5	12	10,5	100	4100	2200	300	1	190	145
32	5	8	10,0	90	3500	1850	300	1	180	140
36	6	6	10,0	105	3900	1800	300	1	180	140
36	5	12	10,5	100	4100	2200	300	1	190	145
48	6	8	10,0	105	3900	1800	300	1	180	140
48	5	12	10,5	100	4100	2200	300	1	190	145
60	5	12	10,5	100	4100	2200	300	1	190	145
64	8	8	12,0	135	4500	2200	300	1	215	170
72	9	8	12,5	150	4750	2150	300	1	225	175
72	6	12	11,0	115	4500	2200	300	1	198	154
96	12	8	14,5	200	5850	2550	300	1	260	205
96	8	12	12,5	150	5150	2750	300	1	225	175
120	10	12	14,0	185	5900	2900	300	1	250	195
128	16	8	15,0	205	5650	2700	300	1	270	210
144	18	8	15,0	205	5650	2700	300	1	270	210
144	12	12	15,5	225	6900	3300	300	1	280	215

Temperature: Storage and transport: - 10°C up to 60°C.

Temperature: Operation: - 20°C up to 60°C.

OPTICAL FIBRE CABLES

APPLICATION

Multitube cable, loose type, non-metallic, dry core, flame retardant and with a LSHF oversheath. Low dimensions and lightweight. Designed for indoor/outdoor applications in duct installation in environments with presence of rodents. Cable installation by pulling or blowing. Easy handling and installation.

CONSTRUCTION CHARACTERISTICS

Optical fibres (at choice)

Single-mode (Dispersion unshifted) – IEC 60793-2 and ITU-T Rec. G.652

Single-mode NZD – ITU-T Rec. G.655

Multi-mode type 50/125 µm – IEC 60793-2 (A1.a) and ITU-T Rec. G.651

Multi-mode type 62,5/125 µm – IEC 60793-2 (A1.b)

Central strength member

Glass fibre reinforced plastic rod (FRP).

Loose Tubes

PBT – tube with optical fibres and filled with gel.

Core watertightness

Dry – waterblocking swelling tape and yarns.

Mechanical reinforcement

Glass fibre yarns.

Ripcord

Oversheath

LSHF – Low Smoke Halogen Free thermoplastic compound, flame retardant.

COLOUR AND CABLE MARKING

Black. Oversheath marked at regular intervals with the following information:

<CABELTE> <type of cable> <composition> <year of manufacture> <metric marking>

FIBRES IDENTIFICATION

Fibres colour code inside tube

1 · White	2 · Red	3 · Green	4 · Blue
5 · Black	6 · Yellow	7 · Orange	8 · Grey
9 · Brown	10 · Rose	11 · Violet	12 · Turquoise

Colour of filling elements

Black

Tubes colour code

Up to 12 tubes

1 · Red	2 up to 11 · Natural	12 · Green
---------	----------------------	------------

16 tubes

1st jacket	White	Red	Blue	Green
2nd jacket	3 White	3 Red	3 Blue	3 Green



Tubes colour code

18 tubes

1st jacket	2 White	2 Red	2 Blue	
2nd jacket	3 White	3 Red	3 Blue	3 Green

GENERAL CHARACTERISTICS

Flame retardant IEC 60332-1-2 • EN 60332-1-2 (cable vertically mounted, length of charred cable ≤ 540 mm)

Oversheath halogen free

Low toxicity IEC 60754-1 • EN 50267-2-1 (halogen acid gas content ≤ 0,5%)

Low corrosivity IEC 60754-2 • EN 50267-2-2 (pH ≥ 4,3 • conductivity ≤ 10µS/mm)

MECHANICAL AND DIMENSIONAL CHARACTERISTICS

Fibres count per cable	N.º of elements	Fibres per tube	Cable diameter (mm)	Cable weight (kg/km)	Max. Pulling force		Mechanical resistance		Minimum bending radius	
					Installed (N)	In service (N)	Crush (N/cm)	Impact (J)	Installed (mm)	In service (mm)
24	5	6	10,0	115	3500	1850	300	1	180	140
24	5	8	10,0	115	3500	1850	300	1	180	140
24	5	12	10,5	125	4100	2200	300	1	190	145
32	5	8	10,0	115	3500	1850	300	1	180	140
36	6	6	10,0	130	3900	1800	300	1	180	140
36	5	12	10,5	125	4100	2200	300	1	190	145
48	6	8	10,0	130	3900	1800	300	1	180	140
48	5	12	10,5	125	4100	2200	300	1	190	145
60	5	12	10,5	125	4100	2200	300	1	190	145
64	8	8	12,0	165	4500	2200	300	1	215	170
72	9	8	12,5	180	4750	2150	300	1	225	175
72	6	12	11,0	140	4500	2200	300	1	198	154
96	12	8	14,5	240	5850	2550	300	1	260	205
96	8	12	12,5	180	5150	2750	300	1	225	175
120	10	12	14,0	220	5900	2900	300	1	250	195
128	16	8	15,0	240	5650	2700	300	1	270	210
144	18	8	15,0	240	5650	2700	300	1	270	210
144	12	12	15,5	265	6900	3300	300	1	280	215

Temperature: Storage and transport: - 10°C up to 60°C.

Temperature: Operation: - 20°C up to 60°C.

OPTICAL FIBRE CABLES

APPLICATION

Multitube cable, loose type, non-metallic, double jacketed, up to 144 fibres.

Loose tubes, dry core, longitudinal water sealing, double jacket, resistant to crush, impact and abrasion.

Recommended for duct or directly buried installation. Cable installation by pulling or blowing. Easy handling and installation.

CONSTRUCTION CHARACTERISTICS

Optical fibres (at choice)

Single-mode (Dispersion unshifted) – IEC 60793-2 and ITU-T Rec. G.652.

Single-mode NZD – ITU-T Rec. G.655.

Multi-mode type 50/125 μm – IEC 60793-2 (A1.a) and ITU-T Rec. G.651.

Multi-mode type 62,5/125 μm – IEC 60793-2 (A1.b).

Central strength member

Glass fibre reinforced plastic rod (FRP).

Loose Tubes

PBT – tube with optical fibres and filled with gel.

Core watertightness

Dry – waterblocking swelling tape and yarns.

Inner jacket

Polyethylene.

Mechanical reinforcement

Aramid fibre yarns placed around the optical core.

Oversheath

Polyethylene.

COLOUR AND CABLE MARKING

Black.

Oversheath marked at regular intervals with the following information:

<CABELTE> <type of cable> <composition> <year of manufacture> <metric marking>

FIBRES IDENTIFICATION

Fibres colour code inside tube

1 · Green	2 · Red	3 · Blue	4 · Yellow
5 · Grey	6 · Violet	7 · Brown	8 · Orange

Tubes colour code

6 tubes

2 White	2 Red	2 Blue
---------	-------	--------

8 tubes

2 White	2 Red	2 Blue	2 Green
---------	-------	--------	---------



Tubes colour code
12 tubes

3 White	3 Red	3 Blue	3 Green
---------	-------	--------	---------

18 tubes

1st jacket	2 White	2 Red	2 Blue	
2nd jacket	3 White	3 Red	3 Blue	3 Green

GENERAL CHARACTERISTICS
Construction standards

ADIF TE-038.003 • Telefonica ER.f6.205:Dec.2003

MECHANICAL AND DIMENSIONAL CHARACTERISTICS – ADIF CONSTRUCTION

Fibres count per cable	N.º of elements	Fibres per tube	Cable diameter (mm)	Cable weight (kg/km)	Max. pulling force (N)	Mechanical resistance		Minimum bending radius	
						Crush (N/cm)	Impact (J)	Installed (mm)	In service (mm)
16	8	2	13,5	135	3 200	260	5	270	205
32	6	8	14,5	155	3 200	260	5	290	220
64	6	5(12)+1(4)	14,5	155	3 200	260	5	290	220
96	12	8	19,0	270	3 200	260	5	380	285
128	18	8	20,5	285	3 200	260	5	410	310

MECHANICAL AND DIMENSIONAL CHARACTERISTICS – TELEFÓNICA CONSTRUCTION

Fibres count per cable	N.º of elements	Fibres per tube	Cable diameter (mm)	Cable weight (kg/km)	Max. pulling force (N)	Mechanical resistance		Minimum bending radius	
						Crush (N/cm)	Impact (J)	Installed (mm)	In service (mm)
6	6	2	14,5	155	4200	260	5	290	220
8	6	2	14,5	155	4200	260	5	290	220
12	6	2	14,5	155	4200	260	5	290	220
16	6	4	14,5	155	4200	260	5	290	220
24	6	4	14,5	155	4200	260	5	290	220
32	6	8	14,5	155	4200	260	5	290	220
48	6	8	14,5	155	4200	260	5	290	220
64	8	8	15,5	175	4200	260	5	310	310
96	12	8	18,5	255	4200	260	5	370	280
128	18	8	19,5	265	4200	260	5	390	295
144	18	8	19,5	265	4200	260	5	390	295

Temperature: Storage and transport: - 10°C up to 60°C.

Temperature: Operation: - 20°C up to 60°C.

OPTICAL FIBRE CABLES

APPLICATION

Multitube cable, loose type, non-metallic, flame retardant, halogen free double jacket, up to 256 fibres. Loose tubes, dry core, longitudinal water sealing, double jacket, resistant to crush, impact and abrasion. Recommended for duct or directly buried installation. Cable installation by pulling or blowing. Easy handling and installation.

CONSTRUCTION CHARACTERISTICS

Optical fibres (at choice)

Single-mode (Dispersion unshifted) – IEC 60793-2 and ITU-T Rec. G.652.

Single-mode NZD – ITU-T Rec. G.655.

Multi-mode type 50/125 μm – IEC 60793-2 (A1.a) and ITU-T Rec. G.651.

Multi-mode type 62,5/125 μm – IEC 60793-2 (A1.b).

Central strength member

Glass fibre reinforced plastic rod (FRP).

Loose Tubes

PBT – tube with optical fibres and filled with gel.

Core watertightness

Dry – waterblocking swelling tape and yarns.

Inner jacket

LSHF – Low Smoke Halogen Free thermoplastic compound, flame retardant.

Mechanical reinforcement

Aramid fibre yarns placed around the optical core.

Oversheath

LSHF – Low Smoke Halogen Free thermoplastic compound, flame retardant.

COLOUR AND CABLE MARKING

Yellow or Black.

Oversheath marked at regular intervals with the following information:

<CABELTE> <type of cable> <composition> <year of manufacture> <metric marking>

FIBRES IDENTIFICATION

Fibres colour code inside tube

1 · Green	2 · Red	3 · Blue	4 · Yellow
5 · Grey	6 · Violet	7 · Brown	8 · Orange

Colour of filling elements

Black

Tubes colour code

6 tubes

2 White	2 Red	2 Blue
---------	-------	--------

8 tubes

2 White	2 Red	2 Blue	2 Green
---------	-------	--------	---------

12 tubes

3 White	3 Red	3 Blue	3 Green
---------	-------	--------	---------



We reserve the right to modify, at any time, without any obligation and without prior notice, the specifications and other technical data in this document, which must be confirmed when ordering.



Tubes colour code

18 tubes

1st jacket	2 White	2 Red	2 Blue	
2nd jacket	3 White	3 Red	3 Blue	3 Green

GENERAL CHARACTERISTICS

Construction standards ADIF TE-038.003 • Telefonica ER.f6.210:Dec.2006

Flame retardant IEC 60332-1-2 • EN 60332-1-2 (cable vertically mounted, length of charred cable ≤ 540 mm)

Fire retardant IEC 60332-3-24 • EN 60332-3-24 (bunch of cables vertically mounted on a ladder, length of charred cable ≤ 2,5 m)

Halogen free

Low smoke IEC 61034-2 • EN 61034-2 (cable light transmittance ≥ 50%)

Low toxicity IEC 60754-1 • EN 50267-2-1 (LSHF sheaths: halogen acid gas content ≤ 0,5%)

Low corrosivity IEC 60754-2 • EN 50267-2-3 (LSHF sheaths: pH ≥ 4,3 • conductivity ≤ 10µS/mm)

MECHANICAL AND DIMENSIONAL CHARACTERISTICS – ADIF CONSTRUCTION

Fibres count per cable	N.º of elements	Fibres per tube	Cable diameter (mm)	Cable weight (kg/km)	Max. pulling force (N)	Mechanical resistance		Minimum bending radius	
						Crush (N/cm)	Impact (J)	Installed (mm)	In service (mm)
32	6	8	14,5	210	3 200	260	5	290	220
64	6	5(12)+1(4)	14,5	210	3 200	260	5	290	220
96	12	8	19,0	340	3 200	260	5	380	285
128	18	8	20,5	365	3 200	260	5	410	310

MECHANICAL AND DIMENSIONAL CHARACTERISTICS – TELEFÓNICA CONSTRUCTION

Fibres count per cable	N.º of elements	Fibres per tube	Cable diameter (mm)	Cable weight (kg/km)	Max. pulling force (N)	Mechanical resistance		Minimum bending radius	
						Crush (N/cm)	Impact (J)	Installed (mm)	In service (mm)
6	6	2	13,0	180	4 200	260	5	290	220
8	6	2	13,0	180	4 200	260	5	290	220
12	6	2	13,0	180	4 200	260	5	290	220
16	6	4	13,0	180	4 200	260	5	290	220
24	6	4	13,0	180	4 200	260	5	290	220
32	6	8	13,0	180	4 200	260	5	290	220
48	6	8	13,0	180	4 200	260	5	290	220
64	8	8	15,0	220	4 200	260	5	310	310
96	12	8	18,0	300	4 200	260	5	370	280
128	18	8	18,5	315	4 200	260	5	390	295
144	18	8	18,5	315	4 200	260	5	390	295
256	18	16	20,0	350	4 200	260	5	400	300

Temperature: Storage and transport: - 10°C up to 60°C.

Temperature: Operation: - 20°C up to 60°C.

OPTICAL FIBRE CABLES

APPLICATION

Superior fibre protection by the use of a double jacket and an armour. Unitube cable, loose type, low dimensions and lightweight, design for outdoor applications, in ducts or directly buried and in environments with presence of rodents. Easy handling and installation.

CONSTRUCTION CHARACTERISTICS

Optical fibres (at choice)

Single-mode (Dispersion unshifted) – IEC 60793-2 and ITU-T Rec. G.652.

Single-mode NZD – ITU-T Rec. G.655.

Multi-mode type 50/125 μm – IEC 60793-2 (A1.a) and ITU-T Rec. G.651.

Multi-mode type 62,5/125 μm – IEC 60793-2 (A1.b).

Loose Tube

PBT – tube with optical fibres and filled with gel.

Mechanical reinforcement

Glass fibre yarns.

Inner jacket

Polyethylene.

Ripcord

Metallic protection

Corrugated coated steel tape.

Oversheath

Polyethylene.

COLOUR AND CABLE MARKING

Black.

Oversheath marked at regular intervals with the following information:

<CABELTE> <type of cable> <composition> <year of manufacture> <metric marking>

FIBRES IDENTIFICATION

Fibres colour code inside tube

1 · White	2 · Red	3 · Green	4 · Blue
5 · Black	6 · Yellow	7 · Orange	8 · Grey
9 · Brown	10 · Rose	11 · Violet	12 · Turquoise
13 · White / Black	14 · Yellow / Black	15 · Orange / Black	16 · Red / Black



MECHANICAL AND DIMENSIONAL CHARACTERISTICS

Fibres count per cable	Fibres per tube	Cable diameter (mm)	Cable weight (kg/km)	Max. Pulling force		Mechanical resistance		Minimum bending radius	
				Installed (N)	In service (N)	Crush (N/cm)	Impact (J)	Installed (mm)	In service (mm)
4	4	10,0	115	1 100	350	200	1	200	160
6	6	10,0	115	1 100	350	200	1	200	160
8	8	10,0	115	1 100	350	200	1	200	160
12	12	10,0	115	1 100	350	200	1	200	160
16	16	11,0	130	1 350	450	200	1	220	175

Temperature: Storage and transport: - 10°C up to 60°C.
 Temperature: Operation: - 20°C up to 60°C.

OPTICAL FIBRE CABLES

APPLICATION

Superior fibre protection by the use of a double jacket and an armour. Unitube cable, loose type, flame retardant and halogen free, low dimensions and lightweight, design for outdoor applications, in ducts or directly buried and in environments with presence of rodents. Easy handling and installation.

CONSTRUCTION CHARACTERISTICS

Optical fibres (at choice)

Single-mode (Dispersion unshifted) – IEC 60793-2 and ITU-T Rec. G.652

Single-mode NZD – ITU-T Rec. G.655

Multi-mode type 50/125 μm – IEC 60793-2 (A1.a) and ITU-T Rec. G.651

Multi-mode type 62,5/125 μm – IEC 60793-2 (A1.b)

Loose Tubes

PBT – tube with optical fibres and filled with gel.

Mechanical reinforcement

Glass fibre yarns.

Ripcord

Inner jacket

LSHF – Low Smoke Halogen Free thermoplastic compound, flame retardant.

Metallic protection

Corrugated coated steel tape.

Oversheath

LSHF – Low Smoke Halogen Free thermoplastic compound, fire retardant.

COLOUR AND CABLE MARKING

Black

Oversheath marked at regular intervals with the following information:

<CABELTE> <type of cable> <composition> <year of manufacture> <metric marking>

FIBRES IDENTIFICATION

Fibres colour code inside tube

1 · White	2 · Red	3 · Green	4 · Blue
5 · Black	6 · Yellow	7 · Orange	8 · Grey
9 · Brown	10 · Rose	11 · Violet	12 · Turquoise
13 · White / Black	14 · Yellow / Black	15 · Orange / Black	16 · Red / Black



GENERAL CHARACTERISTICS

Flame retardant	IEC 60332-1-2 • EN 60332-1-2 (cable vertically mounted, length of charred cable ≤ 540 mm)
Fire retardant	IEC 60332-3-24 • EN 60332-3-24 (bunch of cables vertically mounted on a ladder, length of charred cable ≤ 2,5 m)
Halogen free	
Low smoke	IEC 61034-2 • EN 61034-2 (cable light transmittance ≥ 50%)
Low toxicity	IEC 60754-1 • EN 50267-2-1 (LSHF sheaths: halogen acid gas content ≤ 0,5%)
Low corrosivity	IEC 60754-2 • EN 50267-2-2 (LSHF sheaths: pH ≥4,3 • conductivity ≤ 10µS/mm)

MECHANICAL AND DIMENSIONAL CHARACTERISTICS

Fibres count per cable	Fibres per tube	Cable diameter (mm)	Cable weight (kg/km)	Max. Pulling force		Mechanical resistance		Minimum bending radius	
				Installed (N)	In service (N)	Crush (N/cm)	Impact (J)	Installed (mm)	In service (mm)
4	4	10,0	140	1 400	350	200	1	200	160
6	6	10,0	140	1 400	350	200	1	200	160
8	8	10,0	140	1 400	350	200	1	200	160
12	12	10,0	140	1 400	350	200	1	200	160
16	16	11,0	155	1 550	450	200	1	220	175

Temperature: Storage and transport: - 10°C up to 60°C.

Temperature: Operation: - 20°C up to 60°C.

OPTICAL FIBRE CABLES

APPLICATION

Superior fibre protection by the use of a double jacket and an armour. Multitube cable, loose type, low dimensions and lightweight, design for outdoor applications, in ducts or directly buried and in environments with presence of rodents. Easy handling and installation.

CONSTRUCTION CHARACTERISTICS

Optical fibres (at choice)

Single-mode (Dispersion unshifted) – IEC 60793-2 and ITU-T Rec. G.652.

Single-mode NZD – ITU-T Rec. G.655.

Multi-mode type 50/125 µm – IEC 60793-2 (A1.a) and ITU-T Rec. G.651.

Multi-mode type 62,5/125 µm – IEC 60793-2 (A1.b).

Central strength member

Glass fibre reinforced plastic rod (FRP).

Loose Tubes

PBT – tube with optical fibres and filled with gel.

Core watertightness

Dry – waterblocking swelling tape and yarns.

Mechanical reinforcement

Glass fibre yarns.

Inner jacket

Polyethylene.

Ripcord

Metallic protection

Corrugated coated steel tape.

Oversheath

Polyethylene.

COLOUR AND CABLE MARKING

Black.

Oversheath marked at regular intervals with the following information:

<CABELTE> <type of cable> <composition> <year of manufacture> <metric marking>

Fibres colour code inside tube

1 · White	2 · Red	3 · Green	4 · Blue
5 · Black	6 · Yellow	7 · Orange	8 · Grey
9 · Brown	10 · Rose	11 · Violet	12 · Turquoise

Colour of filling elements

Black.

Tubes colour code

Up to 12 tubes

1 · Red	2 up to 11 · Natural	12 · Green
---------	----------------------	------------

16 tubes

1st jacket	White	Red	Blue	Green
2nd jacket	3 White	3 Red	3 Blue	3 Green



We reserve the right to modify, at any time, without any obligation and without prior notice, the specifications and other technical data in this document, which must be confirmed when ordering.



Tubes colour code

18 tubes

1st jacket	2 White	2 Red	2 Blue	
2nd jacket	3 Black	3 Red	3 Blue	3 Green

MECHANICAL AND DIMENSIONAL CHARACTERISTICS

Fibres count per cable	N.° of elements	Fibres per tube	Cable diameter (mm)	Cable weight (kg/km)	Max. Pulling force		Mechanical resistance		Minimum bending radius	
					Installed (N)	In service (N)	Crush (N/cm)	Impact (J)	Installed (mm)	In service (mm)
24	5	6	14,5	180	1 950	1 050	450	5	350	275
24	5	8	14,5	180	1 950	1 050	450	5	350	275
24	5	12	14,5	190	1 950	1 050	450	5	350	275
32	5	8	14,5	180	1 950	1 050	450	5	350	275
36	6	6	14,5	200	2 050	950	450	5	350	275
36	5	12	14,5	190	1 950	1 050	450	5	350	275
48	6	8	14,5	200	2 050	950	450	5	350	275
48	5	12	14,5	190	1 950	1 050	450	5	350	275
60	5	12	14,5	190	1 950	1 050	450	5	350	275
64	8	8	16,5	240	2 450	1 250	450	5	400	315
72	9	8	16,5	250	2 550	1 200	450	5	400	315
72	6	12	15,5	215	2 200	1 100	450	5	375	300
96	12	8	18,5	315	3 150	1 400	450	5	450	350
96	8	12	16,5	250	2 550	1 400	450	5	400	315
120	10	12	18,5	300	3 000	1 500	450	5	450	350
128	16	8	19,5	330	3 350	1 400	450	5	470	370
144	18	8	19,5	330	3 350	1 400	450	5	470	370
144	12	12	19,5	340	3 450	1 700	450	5	470	370

Temperature: Storage and transport: - 10°C up to 60°C.

Temperature: Operation: - 20°C up to 60°C.

OPTICAL FIBRE CABLES

APPLICATION

Superior fibre protection by the use of a double jacket and an armour. Multitube cable, loose type, fire retardant and halogen free, design for outdoor applications, in ducts or directly buried and in environments with presence of rodents. Easy handling and installation.

CONSTRUCTION CHARACTERISTICS

Optical fibres (at choice)

Single-mode (Dispersion unshifted) – IEC 60793-2 and ITU-T Rec. G.652.

Single-mode NZD – ITU-T Rec. G.655.

Multi-mode type 50/125 μm – IEC 60793-2 (A1.a) and ITU-T Rec. G.651.

Multi-mode type 62,5/125 μm – IEC 60793-2 (A1.b).

Central strength member

Glass fibre reinforced plastic rod (FRP).

Loose Tubes

PBT – tube with optical fibres and filled with gel.

Core watertightness

Dry – waterblocking swelling tape and yarns.

Mechanical reinforcement

Glass fibre yarns.

Inner jacket

LSHF – Low Smoke Halogen Free thermoplastic compound, flame retardant.

Ripcord

Metallic protection

Corrugated coated steel tape.

Oversheath

LSHF – Low Smoke Halogen Free thermoplastic compound, fire retardant.

COLOUR AND CABLE MARKING

Black.

Oversheath marked at regular intervals with the following information:

<CABELTE> <type of cable> <composition> <year of manufacture> <metric marking>

FIBRES IDENTIFICATION

Fibres colour code inside tube

1 · White	2 · Red	3 · Green	4 · Blue
5 · Black	6 · Yellow	7 · Orange	8 · Grey
9 · Brown	10 · Rose	11 · Violet	12 · Turquoise

Colour of filling elements

Black.

Tubes colour code

Up to 12 tubes

1 · Red	2 up to 11 · Natural	12 · Green
---------	----------------------	------------



Tubes colour code

16 tubes

1st jacket	White	Red	Blue	Green
2nd jacket	3 White	3 Red	3 Blue	3 Green

18 tubes

1st jacket	2 White	2 Red	2 Blue	
2nd jacket	3 White	3 Red	3 Blue	3 Green

GENERAL CHARACTERISTICS

Flame retardant IEC 60332-1-2 • EN 60332-1-2 (cable vertically mounted, length of charred cable ≤ 540 mm)

Fire retardant (frt) IEC 60332-3-24 • EN 60332-3-24 (bunch of cables vertically mounted on a ladder, length of charred cable ≤ 2,5 m)

Halogen free

Low smoke

IEC 61034-2 • EN 61034-2 (cable light transmittance ≥ 50%)

Low toxicity

IEC 60754-1 • EN 50267-2-1 (halogen acid gas content ≤ 0,5%)

Low corrosivity

IEC 60754-2 • EN 50267-2-3 (pH ≥ 4,3 • conductivity ≤ 10µS/mm)

MECHANICAL AND DIMENSIONAL CHARACTERISTICS

Fibres count per cable	N.° of elements	Fibres per tube	Cable diameter (mm)	Cable weight (kg/km)	Max. Pulling force		Mechanical resistance		Minimum bending radius	
					Installed (N)	In service (N)	Crush (N/cm)	Impact (J)	Installed (mm)	In service (mm)
24	5	6	14,5	240	2 450	1 300	450	5	350	275
24	5	8	14,5	240	2 450	1 300	450	5	350	275
24	5	12	14,5	245	2 500	1 400	450	5	350	275
32	5	8	14,5	240	2 450	1 300	450	5	350	275
36	6	6	14,5	250	2 500	1 200	450	5	350	275
36	5	12	14,5	245	2 500	1 400	450	5	350	275
48	6	8	14,5	250	2 500	1 200	450	5	350	275
48	5	12	14,5	245	2 500	1 400	450	5	350	275
60	5	12	14,5	245	2 500	1 400	450	5	350	275
64	8	8	16,5	300	3 050	1 550	450	5	400	315
72	9	8	16,5	315	3 200	1 500	450	5	400	315
72	6	12	15,5	275	2 800	1 400	450	5	375	300
96	12	8	18,5	385	3 850	1 800	450	5	450	350
96	8	12	16,5	315	3 200	1 750	450	5	400	315
120	10	12	18,5	370	3 750	1 900	450	5	450	350
128	16	8	19,5	405	4 050	2 050	450	5	470	370
144	18	8	19,5	405	4 050	2 050	450	5	470	370
144	12	12	19,5	420	4 200	2 100	450	5	470	370

Temperature: Storage and transport: - 10°C up to 60°C.

Temperature: Operation: - 20°C up to 60°C.

OPTICAL FIBRE CABLES

APPLICATION

Multitube cable, loose type, armoured, small diameter, design for outdoor applications, in ducts or directly buried and in environments with presence of rodents. Easy handling and installation.

CONSTRUCTION CHARACTERISTICS

Optical fibres (at choice)

Single-mode (Dispersion unshifted) – IEC 60793-2 and ITU-T Rec. G.652.

Single-mode NZD – ITU-T Rec. G.655.

Multi-mode type 50/125 µm – IEC 60793-2 (A1.a) and ITU-T Rec. G.651.

Multi-mode type 62,5/125 µm – IEC 60793-2 (A1.b)

Central strength member

Glass fibre reinforced plastic rod (FRP).

Loose Tubes

PBT – tube with optical fibres and filled with gel.

Core watertightness

Dry – waterblocking swelling tape and yarns.

Mechanical reinforcement

Glassfibres yarns.

Ripcord

Metallic protection

Corrugated coated steel tape.

Oversheath

Polyethylene.

COLOUR AND CABLE MARKING

Black.

Oversheath will be marked, at regular intervals, with the following information:

<CABELTE> <type of cable> <composition> <year of manufacture> <metric marking>

FIBRES IDENTIFICATION

Fibres colour code inside tube

1 · White	2 · Red	3 · Green	4 · Blue
5 · Black	6 · Yellow	7 · Orange	8 · Grey
9 · Brown	10 · Rose	11 · Violet	12 · Turquoise

Colour of filling elements

Black.

Tubes colour code

Up to 12 tubes

1 · Red	2 up to 11 · Natural	12 · Green
---------	----------------------	------------



MECHANICAL AND DIMENSIONAL CHARACTERISTICS

Fibres count per cable	N.° of elements	Fibres per tube	Cable diameter (mm)	Cable weight (kg/km)	Max. pulling force		Mechanical resistance		Minimum bending radius	
					Installation (N)	Permanent (N)	Crush (N/cm)	Impact (J)	Installation (mm)	Permanent (mm)
12	5	6	12,5	160	1 600	550	200	5	300	240
24	5	6	12,5	160	1 600	550	300	5	300	240
36	5	12	13,5	180	1 800	600	300	5	325	255
48	5	12	13,5	180	1 800	600	300	5	325	255
72	6	12	14,5	190	2 000	700	300	5	350	275
96	8	12	15,5	230	2 300	800	300	5	370	295
144	12	12	18,5	320	3 200	1 100	300	5	445	350

Temperature: Storage and transport: - 10°C up to 60°C.

Temperature: Operation: - 20°C up to + 60°C.

OPTICAL FIBRE CABLES

APPLICATION

Superior fibre protection by the use of a double jacket and an armour. Multitube cable, loose type, design for outdoor applications, in ducts or directly buried and in environments with presence of rodents.

PESP-DR – Polyethylene oversheath.

TEST-DR – LSZH oversheath, flame retardant and halogen free.

CONSTRUCTION CHARACTERISTICS

Optical fibres (at choice)

Single-mode (Dispersion unshifted) – IEC 60793-2 and ITU-T Rec. G.652.

Single-mode NZD – ITU-T Rec. G.655.

Multi-mode type 50/125 µm – IEC 60793-2 (A1.a) and ITU-T Rec. G.651.

Multi-mode type 62,5/125 µm – IEC 60793-2 (A1.b).

Central strength member

Glass fibre reinforced plastic rod (FRP).

Loose Tubes

PBT – tube with optical fibres and filled with gel.

Core watertightness

Dry – waterblocking swelling tape and yarns.

Inner Sheath

Polyethylene or LSHF – Low smoke halogen free thermoplastic compound – flame retardant.

Ripcord

Metallic protection

Corrugated coated steel tape.

Oversheath

Polyethylene or LSHF – Low smoke halogen free thermoplastic compound – fire retardant.

COLOUR AND CABLE MARKING

PESP-DR: Black.

TEST-DR: Black or Yellow.

Oversheath marked at regular intervals with the following information:

<CABELTE> <type of cable> <composition> <year of manufacture> <metric marking>

FIBRES IDENTIFICATION

Fibres colour code inside tube

1 · Green	2 · Red	3 · Blue	4 · Yellow
5 · Grey	6 · Violet	7 · Brown	8 · Orange
9 · White	10 · Rose	11 · Black	12 · Turquoise

Colour of filling elements

Black.



Tubes colour code

- 1 tube – White
- 2 tubes – White-Red
- 3 tubes – White-Red-Green
- 4 tubes – 1st jacket White-White-Red-Green
- n tubes – White-...-White-Red-Green

GENERAL CHARACTERISTICS FOR TON GZ12AZ1 · TEST-DR

Flame retardant	IEC 60332-1-2 • EN 60332-1-2 (cable vertically mounted, length of charred cable ≤ 540 mm)
Fire retardant	IEC 60332-3-24 • EN 60332-3-24 (bunch of cables vertically mounted on a ladder, length of charred cable ≤ 2,5 m)
Halogen free	
Low smoke	IEC 61034-2 • EN 61034-2 (cable light transmittance ≥ 60%)
Low toxicity	IEC 60754-1 • EN 50267-2-1 (LSHF sheaths: halogen acid gas content ≤ 0,5%)
Low corrosivity	IEC 60754-2 • EN 50267-2-3 (LSHF sheaths: pH ≥ 4,3 • conductivity ≤ 10µS/mm)

MECHANICAL AND DIMENSIONAL CHARACTERISTICS

Fibres count per cable	N.° of elements	Fibres per tube	Cable diameter (mm)	Cable weight (kg/km)		Max. pulling force (N)	Mechanical resistance		Minimum bending radius	
				PESP-DR	TEST-DR		Crush (N/cm)	Impact (J)	Installed (mm)	In service (mm)
8	6	4	14,5	240	270	2 350	450	5	350	275
12	6	6	14,5	240	270	2 350	450	5	350	275
16	6	4	14,5	240	270	2 350	450	5	350	275
18	6	6	14,5	240	270	2 350	450	5	350	275
24	6	8	14,5	240	270	2 350	450	5	350	275
32	6	8	14,5	240	270	2 350	450	5	350	275
36	6	6	14,5	240	270	2 350	450	5	350	275
48	6	8	14,5	240	270	2 350	450	5	350	275
64	8	8	17,0	275	310	2 450	450	5	410	325
80	10	8	18,0	330	370	2 450	450	5	435	345
96	8	12	18,0	330	370	2 050	450	5	435	345

Temperature: Storage and transport: - 10°C up to 60°C.

Temperature: Operation: - 20°C up to 60°C.

Maximum pulling force 2600N (LASE 1%).

OPTICAL FIBRE CABLES

APPLICATION

Superior fibre protection by the use of a double jacket and an armour. Multitube cable, loose type, design for outdoor applications when it necessary high tensile strength for cable pulling into ducts. Suitable also for directed buried and in environments with presence of rodents.

PKESP – polyethylene oversheath.

TKEST – LSZH oversheath, flame retardant, halogen free.

CONSTRUCTION CHARACTERISTICS

Optical fibres (at choice)

Single-mode (Dispersion unshifted) – IEC 60793-2 and ITU-T Rec. G.652

Single-mode NZD – ITU-T Rec. G.655

Multi-mode type 50/125 μm – IEC 60793-2 (A1.a) and ITU-T Rec. G.651

Multi-mode type 62,5/125 μm – IEC 60793-2 (A1.b)

Central strength member

PBT – tube with optical fibres and filled with a water tightness compound.

Core watertightness

Dry – waterblocking swelling tape and yarns.

Inner Sheath

Polyethylene or LSHF – Low smoke halogen free thermoplastic compound – flame retardant.

Peripheral strength member

Aramid yarns around cable core.

Ripcord

Metallic protection

Corrugated coated steel tape.

Oversheath

Polyethylene or LSHF – Low smoke halogen free thermoplastic compound – fire retardant.

COLOUR AND CABLE MARKING

PKESP: Black.

TKEST: Black or Yellow.

Oversheath marked at regular intervals with the following information:

<CABELTE> <type of cable> <composition> <year of manufacture> <metric marking>

FIBRES IDENTIFICATION

Fibres colour code inside tube

1 · Red	2 · Green	3 · Blue	4 · Yellow
5 · Violet	6 · Orange	7 · Brown	8 · Grey
9 · Black	10 · Rose	11 · Turquoise	12 · White

Colour of filling elements

Black.

Tubes colour code

6 tubes

2 White	2 Red	2 Blue
---------	-------	--------



Tubes colour code
8 tubes

2 White	2 Red	2 Blue	2 Green
---------	-------	--------	---------

12 tubes

3 White	3 Red	3 Blue	3 Green
---------	-------	--------	---------

18 tubes

1st jacket	2 White	2 Red	2 Blue	
2nd jacket	3 White	3 Red	3 Blue	3 Green

GENERAL CHARACTERISTICS FOR TON Z1Za2AZ1 · TEST-DR

Construction standards	ADIF TE-038.003
Flame retardant	IEC 60332-1-2 • EN 60332-1-2 (cable vertically mounted, length of charred cable ≤ 540 mm)
Fire retardant	IEC 60332-3-24 • EN 60332-3-24 (bunch of cables vertically mounted on a ladder, length of charred cable ≤ 2,5 m)
Halogen free	
Low smoke	IEC 61034-2 • EN 61034-2 (cable light transmittance ≥ 50%)
Low toxicity	IEC 60754-1 • EN 50267-2-1 (LSHF sheaths: halogen acid gas content ≤ 0,5%)
Low corrosivity	IEC 60754-2 • EN 50267-2-2 (LSHF sheaths: pH ≥ 4,3 • conductivity ≤ 10µS/mm)

MECHANICAL AND DIMENSIONAL CHARACTERISTICS

Fibres count per cable	N.º of elements	Fibres per tube	Cable diameter (mm)	Cable weight (kg/km)		Max. pulling force (N)	Mechanical resistance		Minimum bending radius	
				PKESP	TKEST		Crush (N/cm)	Impact (J)	Installed (mm)	In service (mm)
32	6	8	16,5	235	290	3 200	260	5	415	330
64	6	5(12)+1(4)	16,5	235	290	3 200	260	5	415	330
96	12	8	22,0	370	460	3 200	260	5	550	440
128	18	8	22,5	400	485	3 200	260	5	565	450

Temperature: Storage and transport: - 10°C up to 60°C.

Temperature: Operation: - 20°C up to 60°C.

OPTICAL FIBRE CABLES

APPLICATION

Multitube loose tube cable, low dimensions and lightweight, watertight. Suitable to for aerial installations, in figure-8.

CONSTRUCTION CHARACTERISTICS

Optical fibres (at choice)

Single-mode (Dispersion unshifted) – IEC 60793-2 and ITU-T Rec. G.652.

Single-mode NZD – ITU-T Rec. G.655.

Multi-mode type 50/125 μm – IEC 60793-2 (A1.a) and ITU-T Rec. G.651.

Multi-mode type 62,5/125 μm – IEC 60793-2 (A1.b).

Central strength member

Glass fibre reinforced plastic rod (FRP).

Loose Tubes

PBT – tube with optical fibres and filled with gel.

Core watertightness

Dry – waterblocking swelling tape and yarns.

Messenger wire

Metallic messenger of galvanized steel.

7 wires with 1mm diameter/each.

Oversheath

Polyethylene.

COLOUR AND CABLE MARKING

Black.

Oversheath marked at regular intervals with the following information:

CABELTE <tipo de cable> <composición> <año de fabricación> <marcado métrico>

FIBRES IDENTIFICATION

Fibres colour code inside tube

1 · White	2 · Red	3 · Green	4 · Blue
5 · Black	6 · Yellow	7 · Orange	8 · Grey
9 · Brown	10 · Rose	11 · Violet	12 · Turquoise

Colour of filling elements

Black.

Tubes colour code

1 · Red	2 · Natural	3 · Natural	4 · Natural	5 · Green
---------	-------------	-------------	-------------	-----------



MECHANICAL AND DIMENSIONAL CHARACTERISTICS

Fibres count per cable	N.° of elements	Fibres per tube	Optical cable diameter (mm)	Cable total height (mm)	Cable weight (Kg/Km)	Maximum pulling force (N)	Mechanical resistance		Minimum bending radius	
							Crush (N/cm)	Impact (J)	Installed (mm)	In service (mm)
12	5	12	11	19	160	2 350	300	1	265	210
24										
36										
48										
60										

Temperature: Storage and transport: - 10°C up to 60°C.

Temperature: Operation: - 20°C up to 60°C.

Minimum breaking load of steel messenger 7 x 1: 6 600 N.

OPTICAL FIBRE CABLES

APPLICATION

All dielectric self-supported cable, suitable to be installed aerially in short spans. Loose tube design, dry core.

CONSTRUCTION CHARACTERISTICS

Optical fibres (at choice)

Single-mode (Dispersion unshifted) – IEC 60793-2 and ITU-T Rec. G.652.

Single-mode NZD – ITU-T Rec. G.655.

Multi-mode type 50/125 μm – IEC 60793-2 (A1.a) and ITU-T Rec. G.651.

Multi-mode type 62,5/125 μm – IEC 60793-2 (A1.b).

Central strength member

Glass fibre reinforced plastic rod (FRP).

Loose Tubes

PBT – tube with optical fibres and filled with gel.

Core watertightness

Dry – waterblocking swelling tape and yarns.

Mechanical reinforcement

Aramid yarns lay around cable core.

If anti-shotgun (antiballistic) protection is required, an aramid tape is applied.

Oversheath

Polyethylene.

COLOUR AND CABLE MARKING

Black.

Oversheath marked at regular intervals with the following information:

<CABELTE> <type of cable> <composition> <year of manufacture> <metric marking>

FIBRES IDENTIFICATION

Fibres colour code inside tube

1 · White	2 · Red	3 · Green	4 · Blue
5 · Black	6 · Yellow	7 · Orange	8 · Grey
9 · Brown	10 · Rose	11 · Violet	12 · Turquoise

Colour of filling elements

Natural.

Tubes colour code

1 · White	2 · Red	3 · Green	4 · Blue
5 · Black	6 · Yellow		



OPTICAL FIBRE CABLES

APPLICATION

All dielectric self-supported cable, suitable to be installed aerially in middle spans.
Loose tube design, dry core.

CONSTRUCTION CHARACTERISTICS

Optical fibres (at choice)

Single-mode (Dispersion unshifted) – IEC 60793-2 and ITU-T Rec. G.652.

Single-mode NZD – ITU-T Rec. G.655.

Multi-mode type 50/125 μm – IEC 60793-2 (A1.a) and ITU-T Rec. G.651.

Multi-mode type 62,5/125 μm – IEC 60793-2 (A1.b).

Central strength member

Glass fibre reinforced plastic rod (FRP).

Loose Tubes

PBT – tube with optical fibres and filled with gel.

Core watertightness

Dry – waterblocking swelling tape and yarns.

Inner jacket

Polyethylene.

Mechanical reinforcement

Two layers of aramid yarns around cable core.

If anti-shotgun (antiballistic) protection is required, an aramid tape is applied.

Oversheath

Polyethylene.

In case of installation on HV transmission lines, the outer jacket provides antitracking protection.

COLOUR AND CABLE MARKING

Black.

Oversheath marked at regular intervals with the following information:

<CABELTE> <type of cable> <composition> <year of manufacture> <metric marking>

FIBRES IDENTIFICATION

Fibres colour code inside tube

1 · White	2 · Red	3 · Green	4 · Blue
5 · Black	6 · Yellow	7 · Orange	8 · Grey
9 · Brown	10 · Rose	11 · Violet	12 · Turquoise

Colour of filling elements

Natural.

Tubes colour code

1 · White	2 · Red	3 · Green	4 · Blue
5 · Black	6 · Yellow		



GENERAL CHARACTERISTICS

Mechanical characteristics

Maximum load EDS	3 600 N
Maximum allowable tension under worst conditions	9 500 N
Resistant cross-sectional area	21,4 mm ²
Young's modulus	98 kN/mm ²
Coefficient of thermal expansion	2,14 x 10 ⁻⁶ °C ⁻¹
Minimum cable sag at installation	2 %
Maximum span (depending on the installation conditions)	300 m

MECHANICAL AND DIMENSIONAL CHARACTERISTICS

Fibres count per cable	N.° of elements	Fibres per tube	Cable diameter (mm)	Cable weight (kg/km)	Breaking Load Minimum (N)	Mechanical resistance		Minimum bending radius	
						Crush (N/cm)	Impact (J)	Installed (mm)	In service (mm)
12	6	12	16	220	52 000	250	1,5	280	210
24									
36									
48									
60									
72									

Temperature: Storage and transport: - 10°C up to 60°C.

Temperature: Operation: - 20°C up to 60°C.

OPTICAL FIBRE

Single-mode

- Zero dispersion shifted fibre ITU-T G.652B
- Zero dispersion shifted fibre ITU-T G.652D
- Non-zero dispersion shifted fibre ITU-T G.655

Multimode

- 50/125 OM1
- 50/125 OM2
- 50/125 OM3
- 62,5/125 OM1
- 62,5/125 OM2

Single-mode optical fibre dispersion unshifted, according to ITU -T G.652 – Tables A and B, and to IEC 60793-2-50 type B1.1.

OPTICAL CHARACTERISTICS

	Specified value
Attenuation coefficient on stranded fibre	
at 1310 nm	≤ 0,38 dB/km
at 1550 nm	≤ 0,24 dB/km
at 1625 nm	≤ 0,32 dB/km
Mode field diameter	
at 1310 nm	9,2 μm ± 0,5 μm
at 1550 nm	10,4 μm ± 0,7 μm
Cable cut-off wavelength (λ_{cc})	$\lambda_{cc} \leq 1260$ nm
Chromatic dispersion	
Zero dispersion wavelength (λ_0)	1300 nm ≤ λ_0 ≤ 1324 nm
Zero dispersion slope	≤ 0,093 ps/(nm ² .km)
Dispersion in 1285 nm – 1330 nm	≤ 3,5 ps/(nm.km)
Dispersion in 1271 nm – 1360 nm	≤ 5,3 ps/(nm.km)
Dispersion at 1550 nm	≤ 18 ps/(nm.km)
PMD – Polarization Mode Dispersion (on cable)	≤ 0,5 ps/(√km) *
Attenuation discontinuity	≤ 0,1 dB
Longitudinal attenuation uniformity at 1310 nm and at 1550 nm (1000 m window)	≤ 0,05 dB/km
Attenuation with bending at 1550 nm and at 1625 nm (100 turns, Ø 60 mm)	≤ 0,1 dB

DIMENSIONAL CHARACTERISTICS

	Specified value
Core-cladding concentricity error	≤ 0,6 μm
Cladding diameter	125 μm ± 1 μm
Cladding non-circularity	≤ 1,0 %
Coating diameter (uncoloured)	245 μm ± 10 μm
Coating-cladding concentricity error	≤ 12 μm
Coating diameter (coloured)	250 μm ± 15 μm

MECHANICAL CHARACTERISTICS

	Specified value
Fibre curl radius	≥ 4 m
Fibre proof test	≥ 100 kPSI; 0,7 Gpa
Coating strip force (indicative)	1 N ≤ F _{Aver. strip} ≤ 5 N
Fatigue resistance parameter (n_d)	≥ 20

* PMD_Q ≤ 0,2 ps/√km according to ITU-T G.652

ENVIRONMENTAL CHARACTERISTICS

	Specified value Change in attenuation on bare fibre
Change of temperature: -60°C at +85°C at 1310 nm and at 1550 nm	≤ 0,05 dB/Km
Damp heat: +85°C, 85% R.H., 30 days at 1310 nm and at 1550 nm	≤ 0,05 dB/Km
Dry heat: +85°C, 30 days at 1310 nm and at 1550 nm	≤ 0,05 dB/Km
Water immersion: 23°C ± 5°C, 30 days at 1310 nm and at 1550 nm	≤ 0,05 dB/Km

Single-mode optical fibre dispersion unshifted, according to ITU -T G.652 – Tables A, B, C and D, and to IEC 60793-2-50 type B1.1 and type B1.3.

OPTICAL CHARACTERISTICS

	Specified value
Attenuation coefficient on stranded fibre	
at 1310 nm	≤ 0,36 dB/km
at 1383 nm	≤ 0,38 dB/km
at 1550 nm	≤ 0,22 dB/km
at 1625 nm	≤ 0,30 dB/km
Mode field diameter	
at 1310 nm	9,2 μm ± 0,5 μm
at 1550 nm	10,4 μm ± 0,7 μm
Cable cut-off wavelength (λ _{cc})	λ _{cc} ≤ 1260 nm
Chromatic dispersion	
Zero dispersion wavelength (λ ₀)	1300 nm ≤ λ ₀ ≤ 1324 nm
Zero dispersion slope	≤ 0,092 ps/(nm ² .km)
Dispersion in 1285 nm – 1330 nm	≤ 3,5 ps/(nm.km)
Dispersion in 1271 nm – 1360 nm	≤ 5,3 ps/(nm.km)
Dispersion at 1550 nm	≤ 18 ps/(nm.km)
Polarization Mode Dispersion (on cable)	≤ 0,2 ps/(√km)
Attenuation discontinuity	≤ 0,1 dB
Longitudinal attenuation uniformity at 1310 nm and at 1550 nm (1000 m window)	≤ 0,05 dB/km
Attenuation with bending, at 1625 nm (100 turns, Ø 60 mm)	≤ 0,1 dB

DIMENSIONAL CHARACTERISTICS

	Specified value
Core-cladding concentricity error	≤ 0,6 μm
Cladding diameter	125 μm ± 1 μm
Cladding non-circularity	≤ 1,0 %
Coating diameter (uncoloured)	245 μm ± 10 μm
Coating-cladding concentricity error	≤ 12 μm
Coating diameter (coloured)	250 μm ± 15 μm

MECHANICAL CHARACTERISTICS

	Specified value
Fiber curl radius	≥ 4 m
Fibre proof test	≥ 100 kPSI; 0,7 Gpa
Coating strip force (indicative)	1 N ≤ F _{Aver. strip} ≤ 5 N
Fatigue resistance parameter (n _d)	≥ 20

ENVIRONMENTAL CHARACTERISTICS

	Specified value Change in attenuation on bare fibre
Change of temperature: -60°C up to +85°C at 1310 nm and at 1550 nm	≤ 0,05 dB/Km
Damp heat: +85°C, 85% R.H., 30 days at 1310 nm and at 1550 nm	≤ 0,05 dB/Km
Dry heat: +85°C, 30 days at 1310 nm and at 1550 nm	≤ 0,05 dB/Km
Water immersion: 23°C ± 5°C, 30 days at 1310 nm and at 1550 nm	≤ 0,05 dB/Km

Single-mode, non-zero dispersion shifted fibre,
according to ITU-T G.655 C.

OPTICAL CHARACTERISTICS

	Specified value
Attenuation coefficient on stranded fibre	
at 1550 nm	≤ 0,23 dB/km
at 1625 nm	≤ 0,25 dB/km
Mode field diameter	
at 1550 nm	9,6 μm ± 0,5 μm
Cable cut-off wavelength (λ _{cc})	λ _{cc} ≤ 1450 nm
Dispersion	
between 1530 nm – 1565 nm	2,0 a 6,0 ps/(nm.km)
between 1565 nm – 1625 nm	4,5 a 11,2 ps/(nm.km)
PMD – Polarization Mode Dispersion (on cable)	≤ 0,2 ps/(√km)
Attenuation discontinuity	≤ 0,1 dB
Longitudinal attenuation uniformity at 1310 nm and at 1550 nm (1000 m window)	≤ 0,05 dB/km
Attenuation with bending, at 1625 nm (100 turns, Ø 60 mm)	≤ 0,1 dB

DIMENSIONAL CHARACTERISTICS

	Specified value
Core-cladding concentricity error	≤ 0,6 μm
Cladding diameter	125 μm ± 1 μm
Cladding non-circularity	≤ 1,0 %
Coating diameter (uncoloured)	245 μm ± 10 μm
Coating-cladding concentricity error	≤ 12 μm
Coating diameter (coloured)	250 μm ± 15 μm

MECHANICAL CHARACTERISTICS

	Specified value
Fiber curl radius	≥ 4 m
Fibre proof test	≥ 100 kPSI; 0,7 Gpa
Coating strip force (indicative)	1 N ≤ F _{Aver. strip} ≤ 5 N
Fatigue resistance parameter (n _d)	≥ 20

ENVIRONMENTAL CHARACTERISTICS

	Specified value
	Change in attenuation on bare fibre
Change of temperature: -60°C up to +85°C at 1550 nm and at 1625 nm	≤ 0,05 dB/Km
Damp heat: +85°C, 85% R.H., 30 days at 1550 nm and at 1625 nm	≤ 0,05 dB/Km
Dry heat: +85°C, 30 days at 1550 nm and at 1625 nm	≤ 0,05 dB/Km
Water immersion: 23°C ± 5°C, 30 days at 1550 nm and at 1625 nm	≤ 0,05 dB/Km

Multi-mode optical fibre 50/125,
type OM1 according to ISO/IEC 11801 and type A1a.1 according to IEC 60793-2-10.

OPTICAL CHARACTERISTICS

	Specified value
Attenuation coefficient on stranded fibre	
at 850 nm	≤ 3,0 dB/km
at 1300 nm	≤ 1,0 dB/km
Bandwidth (Overfilled launch)	
at 850 nm	≥ 200 MHz x km
at 1300 nm	≥ 500 MHz x km
Numerical aperture	0,20 ± 0,15
Macrobending loss at 850 nm and at 1300 nm (100 turns, Ø 75 mm)	≤ 0,5 dB
Attenuation discontinuities	≤ 0,2 dB

GEOMETRICAL CHARACTERISTICS

	Specified value
Mode field diameter	50 µm ± 3 µm
Cladding diameter	125 µm ± 2 µm
Cladding non-circularity	≤ 2 %
Core-cladding concentricity error	≤ 3 µm
Core non-circularity	≤ 6 %
Coating diameter (uncoloured)	245 µm ± 10 µm
Coating-cladding concentricity error	≤ 12,5 µm
Coating diameter (coloured)	250 µm ± 15 µm

MECHANICAL CHARACTERISTICS

	Specified value
Fibre proof test	≥ 100 kPSI; 0,7 Gpa
Coating strip force (indicative)	1 N ≤ F _{Aver. strip} ≤ 5 N
Fatigue resistance parameter (n _d)	≥ 20

ENVIRONMENTAL CHARACTERISTICS

	Specified value
	Change in attenuation on bare fibre
Change of temperature: -60°C up to +85°C at 850 nm and at 1300 nm	≤ 0,20 dB/Km
Damp heat: +85°C, 85% R.H., 30 days at 850 nm and at 1300 nm	≤ 0,20 dB/Km
Dry heat: +85°C, 30 days at 850 nm and at 1300 nm	≤ 0,20 dB/Km
Water immersion: 23°C ± 5°C, 30 days at 850 nm and at 1300 nm	≤ 0,20 dB/Km

Multimode optical fibre 50/125,
type OM2 according to ISO/IEC 11801 and type A1a.1 according to IEC 60793-2-10.

OPTICAL CHARACTERISTICS

	Specified value
Attenuation coefficient on stranded fibre	
at 850 nm	≤ 3,0 dB/km
at 1300 nm	≤ 1,0 dB/km
Bandwidth (Overfilled launch)	
at 850 nm	≥ 500 MHz x km
at 1300 nm	≥ 500 MHz x km
Numerical aperture	0,20 ± 0,015
Macrobending loss at 850 nm and at 1300 nm (100 turns, Ø 75 mm)	≤ 0,5 dB
Attenuation discontinuities	≤ 0,2 dB

GEOMETRICAL CHARACTERISTICS

	Specified value
Mode field diameter	50 µm ± 3 µm
Cladding diameter	125 µm ± 2 µm
Cladding non-circularity	≤ 2 %
Core-cladding concentricity error	≤ 3 µm
Core non-circularity	≤ 6 %
Coating diameter (uncoloured)	245 µm ± 10 µm
Coating-cladding concentricity error	≤ 12,5 µm
Coating diameter (coloured)	250 µm ± 15 µm

MECHANICAL CHARACTERISTICS

	Specified value
Fibre proof test	≥ 100 kPSI; 0,7 Gpa
Coating strip force (indicative)	1 N ≤ F _{Aver. strip} ≤ 5 N
Fatigue resistance parameter (n _d)	≥ 20

ENVIRONMENTAL CHARACTERISTICS

	Specified value
	Change in attenuation on bare fibre
Change of temperature: -60°C up to +85°C at 850 nm and at 1300 nm	≤ 0,20 dB/Km
Damp heat: +85°C, 85% R.H., 30 days at 850 nm and at 1300 nm	≤ 0,20 dB/Km
Dry heat: +85°C, 30 days at 850 nm and at 1300 nm	≤ 0,20 dB/Km
Water immersion: 23°C ± 5°C, 30 days at 850 nm and at 1300 nm	≤ 0,20 dB/Km

Multimode optical fibre 50/125, type OM3 according to ISO/IEC 11801 and type A1a.2 according to IEC 60793-2-10.

OPTICAL CHARACTERISTICS

	Specified value
Attenuation coefficient on stranded fibre	
at 850 nm	≤ 3,0 dB/km
at 1300 nm	≤ 1,0 dB/km
Bandwidth (Overfilled launch)	
at 850 nm	≥ 1500 MHz x km
at 1300 nm	≥ 500 MHz x km
Effective modal bandwidth	
at 850 nm	≥ 2000 MHz x km
Numerical aperture	0,20 ± 0,015
Macrobending loss at 850 nm and at 1300 nm (100 turns, Ø 75 mm)	≤ 0,5 dB
Attenuation discontinuities	≤ 0,2 dB

GEOMETRICAL CHARACTERISTICS

	Specified value
Mode field diameter	50 µm ± 3 µm
Cladding diameter	125 µm ± 2 µm
Cladding non-circularity	≤ 2 %
Core-cladding concentricity error	≤ 3 µm
Core non-circularity	≤ 6 %
Coating diameter (uncoloured)	245 µm ± 10 µm
Coating-cladding concentricity error	≤ 12,5 µm
Coating diameter (coloured)	250 µm ± 15 µm

MECHANICAL CHARACTERISTICS

	Specified value
Fibre proof test	≥ 100 kPSI; 0,7 Gpa
Coating strip force (indicative)	1 N ≤ F _{Aver. strip} ≤ 5 N
Fatigue resistance parameter (n _d)	≥ 20

ENVIRONMENTAL CHARACTERISTICS

	Specified value
	Change in attenuation on bare fibre
Change of temperature: -60°C up to +85°C at 850 nm and at 1300 nm	≤ 0,20 dB/Km
Damp heat: +85°C, 85% R.H., 30 days at 850 nm and at 1300 nm	≤ 0,20 dB/Km
Dry heat: +85°C, 30 days at 850 nm and at 1300 nm	≤ 0,20 dB/Km
Water immersion: 23°C ± 5°C, 30 days at 850 nm and at 1300 nm	≤ 0,20 dB/Km

Multimode optical fibre 62,5/125, type OM1
According to ISO/IEC 11801 and type A1b according to IEC 60793-2-10.

OPTICAL CHARACTERISTICS

	Specified value
Attenuation coefficient on stranded fibre	
at 850 nm	≤ 3,2 dB/km
at 1300 nm	≤ 1,0 dB/km
Bandwidth (Overfilled launch)	
at 850 nm	≥ 200 MHz x km
at 1300 nm	≥ 500 MHz x km
Numerical aperture	0,275 ± 0,015
Macrobending loss at 850 nm and at 1300 nm (100 turns, Ø 75 mm)	≤ 0,5 dB
Attenuation discontinuities	≤ 0,2 dB

GEOMETRICAL CHARACTERISTICS

	Specified value
Mode field diameter	62,5 µm ± 3 µm
Cladding diameter	125 µm ± 2 µm
Cladding non-circularity	≤ 2 %
Core-cladding concentricity error	≤ 3 µm
Core non-circularity	≤ 6 %
Coating diameter (uncoloured)	245 µm ± 10 µm
Coating-cladding concentricity error	≤ 12,5 µm
Coating diameter (coloured)	250 µm ± 15 µm

MECHANICAL CHARACTERISTICS

	Specified value
Fibre proof test	≥ 100 kPSI; 0,7 Gpa
Coating strip force (indicative)	1 N ≤ F _{Aver. strip} ≤ 5 N
Fatigue resistance parameter (n _d)	≥ 20

ENVIRONMENTAL CHARACTERISTICS

	Specified value
	Change in attenuation on bare fibre
Change of temperature: -60°C up to +85°C at 850 nm and at 1300 nm	≤ 0,20 dB/Km
Damp heat: +85°C, 85% R.H., 30 days at 850 nm and at 1300 nm	≤ 0,20 dB/Km
Dry heat: +85°C, 30 days at 850 nm and at 1300 nm	≤ 0,20 dB/Km
Water immersion: 23°C ± 5°C, 30 days at 850 nm and at 1300 nm	≤ 0,20 dB/Km

Multimode optical fibre 62,5/125, type OM2
according to ISO/IEC 11801 and type A1b according to IEC 60793-2-10.

OPTICAL CHARACTERISTICS

	Specified value
Attenuation coefficient on stranded fibre	
at 850 nm	≤ 3,2 dB/km
at 1300 nm	≤ 1,0 dB/km
Bandwidth (Overfilled launch)	
at 850 nm	≥ 500 MHz x km
at 1300 nm	≥ 500 MHz x km
Numerical aperture	0,275 ± 0,015
Macrobending loss at 850 nm and at 1300 nm (100 turns, Ø 75 mm)	≤ 0,5 dB
Attenuation discontinuities	≤ 0,2 dB

GEOMETRICAL CHARACTERISTICS

	Specified value
Mode field diameter	62,5 µm ± 3 µm
Cladding diameter	125 µm ± 2 µm
Cladding non-circularity	≤ 2 %
Core-cladding concentricity error	≤ 3 µm
Core non-circularity	≤ 6 %
Coating diameter (uncoloured)	245 µm ± 10 µm
Coating-cladding concentricity error	≤ 12,5 µm
Coating diameter (coloured)	250 µm ± 15 µm

MECHANICAL CHARACTERISTICS

	Specified value
Fibre proof test	≥ 100 kPSI; 0,7 Gpa
Coating strip force (indicative)	1 N ≤ F _{Aver. strip} ≤ 5 N
Fatigue resistance parameter (n _d)	≥ 20

ENVIRONMENTAL CHARACTERISTICS

	Specified value
	Change in attenuation on bare fibre
Change of temperature: -60°C up to +85°C at 850 nm and at 1300 nm	≤ 0,20 dB/Km
Damp heat: +85°C, 85% R.H., 30 days at 850 nm and at 1300 nm	≤ 0,20 dB/Km
Dry heat: +85°C, 30 days at 850 nm and at 1300 nm	≤ 0,20 dB/Km
Water immersion: 23°C ± 5°C, 30 days at 850 nm and at 1300 nm	≤ 0,20 dB/Km

SERVICE AND ACCESSORIES

SERVICE AND ACCESSORIES



SERVICE AND ACCESSORIES

“TURN-KEY” SOLUTIONS

The experience gained over the years by Cabelte and the close relationship maintained with customers have enabled it to, progressively, expand its field of action, always with the intention of providing greater value to the customer.

This business area, integrated in the Special Projects Department of Cabelte, deals with “turnkey” service by focusing on the design of customized solutions associated with high value-added products.

Electric aerial lines

In the field of electrical networks, Cabelte designs, develops and installs optical cables, both ADSS and OPGW for aerial power lines.

Some projects could involve: mechanical calculation of the line, determination of sag and regulation tensions, selecting of accessories, vibrations studies with determination of the location of dampers. In the case of ADSS cables placed near high voltage power lines, Cabelte also perform electrical field calculation in order to determined the ideal position of cable in tower, in order to minimize tracking erosion effects.

Supervision

Due to the high stresses that cable may be subjected during some types of installation, as in the case of high and very high voltage aerial lines, and the need to ensure the integrity of the cable, it is necessary to make a very rigorous control of all installation steps, from the unwinding up to start-up.

The specialized team supervises the installation of “turnkey” projects but also acts as support to customers at their request.

Structured networks

The company carry out structured networks of copper and optical fibre, being responsible for the network cabling design, installation and the tests required.

Customized solutions

Within the specific area of optical infrastructures, especially in network cabling, Cabelte has implemented solutions for different kind of environments, responding to requirements related with the need to reduce installation time or designing solutions that could be installed in existing infra structures, such as in the case of optical cables in pluvial water draining networks.



SERVICES

CABELTE GROUP has specialized teams for:

Making optical connections and tests

Making the test of FTTH networks

In addition of carrying out optical connections, splices (joints) and terminations, Cabelte also proposes, in many cases, tailored services, and may even develop special solutions, for racks or cabinets depending on the specific need of fibre distribution, handling, maintenance and systems evolution.

Cabelte can also carry out full monitoring of any optical network since it has the means to perform tests on field:

- Optical reflectometers for measuring attenuation coefficient and losses on optical fibre splices;
- Optical reflectometers for measuring the parameters of FTTH networks with splitters included;
- Light sources and power meters to measure total attenuation of the connection;
- PMD measuring, interferometry method.

The company executes connections and cable terminations of high voltage power cables up to 84kV.

PORTFOLIO

The solutions developed and designed by Cabelte Group are currently in operation in various fields, among which we highlight:

- Renewable energy;
- Highways and railroads;
- Electrical power networks for medium, high and very high voltage;
- Military infrastructure;
- Structures and civil buildings;
- Digital network;
- SCADA networks for water supply;
- Telecommunication network



ACCESSORIES FOR CABLES

Cabelte offers a wide range of accessories to complement the supply of electrical and telecommunication cables, among which:

- Optical fibre connectors;
- Patch panels and DFU's (Distribution fibre units);
- Joint closures for optical fibre cables;
- Telecommunication racks;
- Suspension strings/support for optical fibre cables;
- Dampers for electrical power aerial lines;
- Cable joints for medium and high voltage power cables;
- Cable termination for medium and high voltage power cables.

DISCOVERY



Foreign Trade Consultants & Marketing Solutions

Contact Detail:



Head Office Tel : +90 216 483 3565 Web Site : www.discovery-trd.com

Head Office Fax: +90 216 483 3526 E-Mails : og@discovery-trd.com

Mobile Number : +90 554 625 0015

Mobile Number : +90 532 611 2094

og_jo@discovery-trd.com
discovery@discovery-trd.com
bersan@discovery-trd.com
ahmet@discovery-trd.com
ilyas@discovery-trd.com



KEŞİF DIŞ TİCARET VE PAZARLAMA ÇÖZÜMLERİ

Aydınlı Yolu Cad. Bahçelievler Mah. Eryetis Sitesi B/Blok No: 33 Kat: 6 Daire: 21 Pendik - İstanbul

Tel: 0090 216 483 35 65 Fax: 0090 216 483 35 26

www.discovery-trd.com email: dscovey@discovery-trd.com

